

# Installation Instructions and Reference Handbook



-power in control

## GC-1/GC-1M Generator Controller

4189340396H

SW 1.4X.X

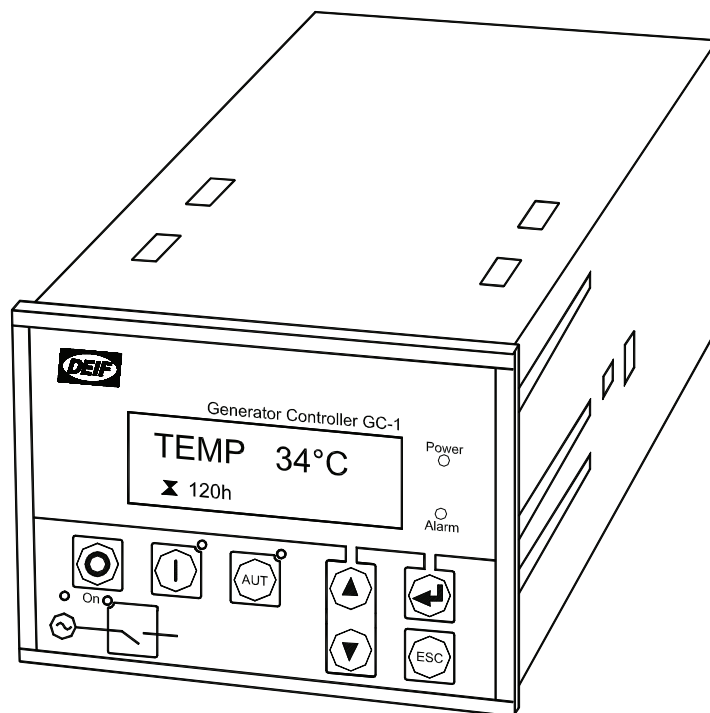

- *Installation instructions*
- *Functional descriptions*
- *Parameter list*

DEIF A/S



DEIF A/S, Frisenborgvej 33  
DK-7800 Skive, Denmark

Tel.: +45 9614 9614, Fax: +45 9614 9615  
E-mail: [deif@deif.com](mailto:deif@deif.com), URL: [www.deif.com](http://www.deif.com)



## Table of contents

<b>1. ABOUT THIS DOCUMENT .....</b>	<b>4</b>
GENERAL PURPOSE .....	4
INTENDED USERS .....	4
CONTENTS/OVERALL STRUCTURE .....	4
<b>2. WARNINGS AND LEGAL INFORMATION .....</b>	<b>6</b>
LEGAL INFORMATION AND RESPONSIBILITY .....	6
ELECTROSTATIC DISCHARGE AWARENESS .....	6
SAFETY ISSUES .....	6
FACTORY SETTINGS .....	6
DEFINITIONS.....	6
<b>3. GENERAL PRODUCT INFORMATION.....</b>	<b>7</b>
INTRODUCTION .....	7
TYPE OF PRODUCT .....	7
STANDARD FUNCTIONS .....	7
OPTIONS.....	8
<b>4. INSTALLATION INSTRUCTIONS .....</b>	<b>9</b>
MOUNTING .....	9
TERMINALS .....	9
WIRING .....	12
BINARY INPUTS .....	13
CHARGER ALTERNATOR CONNECTIONS.....	14
CONNECTION OF THE 3-PHASE VOLTAGE AND CURRENT .....	15
CONNECTION OF THE 1-PHASE VOLTAGE AND CURRENT .....	15
TECHNICAL INFORMATION.....	16
<b>5. PUSH-BUTTONS, LEDS AND DISPLAY .....</b>	<b>19</b>
UNIT.....	19
ICON LIST .....	22
<b>6. FUNCTIONAL DESCRIPTIONS .....</b>	<b>26</b>
ALARM FUNCTION.....	26
TIMER FUNCTION.....	26
UTILITY SOFTWARE INPUT CONFIGURATION .....	27
FAIL CLASS .....	32
SERVICE TIMERS.....	32
VDO SENSORS.....	33
BINARY INPUTS WITH CABLE SUPERVISION .....	37
FUEL PUMP LOGIC .....	37
4-20mA INPUTS .....	39
GENERATOR BREAKER CONTROL .....	42
THE GC-1/GC-1M IN IT NETWORKS.....	43
GSM COMMUNICATION .....	44
UTILITY SOFTWARE CONNECTION VIA MODEM .....	45
PC UTILITY SOFTWARE COMMUNICATION SAFETY .....	46
AUTO ENGINE START .....	47
START SEQUENCES.....	48
STOP SEQUENCES .....	53
<b>7. PARAMETER LIST .....</b>	<b>55</b>
PARAMETER GROUPS .....	55
SETUP .....	55
FAIL CLASS .....	58
ENGINE ALARM SETTINGS (PROTECTION) .....	58
VDO INPUTS .....	60

4-20MA INPUTS ..... 62  
BINARY INPUTS WITH CABLE SUPERVISION ..... 63  
TACHO RPM INPUT ..... 64  
Hz/V MONITORING SETTINGS ..... 70

## 1. About this document

---

This chapter includes general user information about this handbook concerning the general purpose, the intended users, the overall purpose and the overall contents and structure.

### General purpose

This document is the Installation Instructions and Reference Handbook for DEIF's Generator Controller, the GC-1 and GC-1M. The document mainly includes installation instructions, presentation of push-buttons, LEDs and display, functional descriptions and complete standard parameter lists.

The general purpose of the Installation Instructions and Reference Handbook is to provide the information needed to install the unit correctly and to provide information about the functionality of the unit and its applications. The handbook also offers the user the information he needs in order to successfully set up the parameters needed in his specific application.



**Please make sure to read this handbook before working with the Multi-line 2 controller and the gen-set to be controlled. Failure to do this could result in human injury or damage to the equipment.**

### Intended users

The handbook is mainly intended for the person responsible for installing the unit and for the person responsible for the unit setup. Naturally, others might also find useful information in the handbook.

### Contents/overall structure

The Installation Instructions and Reference Handbook is divided into chapters and in order to make the structure of the document simple and easy to use, each chapter will begin from the top of a new page. The following will outline the contents of each of the chapters.

#### About this document

This first chapter includes general information about this handbook as a document. It deals with the general purpose and the intended users of the Installation Instructions and Reference Handbook. Furthermore, it outlines the overall contents and structure of the document.

#### Warnings and legal information

The second chapter includes information about general legal issues and safety precautions relevant in the handling of DEIF products. Furthermore, this chapter will introduce note and warning symbols, which will be used throughout the handbook.

#### General product information

The third chapter will deal with the unit in general and its place in the DEIF product range.

#### Installation instructions

This chapter includes the information needed to perform correct installation of the unit, e.g. mounting instructions, terminals, wiring, inputs etc.

#### Push-buttons, LEDs and display

This chapter deals with push-button and LED functions. Furthermore, information about the display including icon list is presented.

**Functional descriptions**

This chapter includes functional descriptions for the unit's standard functions. Screen dumps and flow charts are used in order to simplify the information.

**Parameter list**

This chapter includes a complete standard parameter list for setup. Therefore, this chapter is to be used for reference, when information about specific parameters is needed.

## 2. Warnings and legal information

This chapter includes important information about general legal issues relevant in the handling of DEIF products. Furthermore, some overall safety precautions will be introduced and recommended. Finally, the highlighted notes and warnings, which will be used throughout the document, are presented.

### Legal information and responsibility

DEIF takes no responsibility for installation or operation of the generator set. If there is any doubt about how to install or operate the generator set controlled by the unit, the company responsible for the installation or the operation of the set must be contacted.

**The units are not to be opened by unauthorised personnel. If opened anyway, the warranty will be lost.**



**For use in approved marine installations: Secondary independent engine protection may be required to meet the classification rules requirements. Failure to do so may result in violation of the rules. Please refer to the approving society for further information.**

### Electrostatic discharge awareness

Sufficient care must be taken to protect the terminals against static discharges during the installation. Once the unit is installed and connected, these precautions are no longer necessary.

### Safety issues

Installing the unit implies work with dangerous currents and voltages. Therefore, the installation should only be carried out by authorised personnel who understand the risks involved in working with live electrical equipment.



**Be aware of the hazardous live currents and voltages. Do not touch any AC measurement inputs as this could lead to injury or death.**

### Factory settings

The unit is delivered with certain factory settings. Given the fact that these settings are based on average values, they are not necessarily the correct settings for matching the individual engine. Thus precautions must be taken to check the settings before running the engine.

### Definitions

Throughout this document a number of notes and warnings will be presented. To ensure that these are noticed, they will be highlighted in order to separate them from the general text.

### Notes



**The notes provide general information which will be helpful for the reader to bear in mind.**

### Warnings



**The warnings indicate a potentially dangerous situation which could result in death, personal injury or damaged equipment, if certain guidelines are not followed.**

### 3. General product information

---

This chapter includes overall product information about the unit in general and its place in the DEIF product range.

#### Introduction

The concept of GC-1/GC-1M is to offer a simple and effective solution to gen-set builders, who need a flexible yet cost-competitive protection and control unit for small and medium-sized generators.

#### Type of product

The Generator Controller GC-1/GC-1M is a micro-processor based control unit containing all necessary functions for protection and control of a power generator. Besides the control and protection of the diesel engine it contains a full 3-phase AC voltage and current measuring circuit. The unit is equipped with an LCD display presenting all values and alarms.

#### Standard functions

##### Engine control

- Start preparation (preheater or prelubrication)
- Start/stop sequences with selectable no. of start attempts
- Fuel solenoid selection (coil type)
- Idle speed control
- Local or remote start/stop
- Stop sequence with cool-down
- Running speed detection selectable
  - Generator Hz/V
  - Charger alternator input (W terminal)
  - Binary input (D+)
  - Oil pressure

##### Engine monitoring

- 3 configurable inputs, all selectable between
  - VDO or
  - 4-20mA from active transducer or
  - Binary with cable supervision
- 6 binary inputs, configurable
- RPM input, selectable
  - Magnetic pickup
  - NPN or PNP pickup
  - Tacho generator
  - Charger alternator W terminal

##### Generator monitoring

- 3-phase or single phase generator monitoring
  - Voltage/current/frequency/power/reactive power

##### Generator protection (ANSI)

- Over-/undervoltage (27/59)
- Over-/underfrequency (81)
- Overcurrent (51)
- Reverse power (32)

**Clear text display**

- 122 x 32 pixel backlight STN
- Graphic symbol messaging
- Clear text alarm messages
- Clear text diagnostics for both hardwired inputs and CANbus messages (J1939)
- Log book holding 30 log entries
- Real time clock for time and date

**Options**

The basic GC-1/GC-1M generator controller unit can be equipped with an AMF option needed to provide a real emergency power system controller. Furthermore, CANbus communication for different engine types is available.



**A full options list is included in the data sheet.**



## 4. Installation instructions

This chapter includes the information needed to perform correct installation of the unit, e.g. mounting instructions, terminals, wiring, inputs etc.

### Mounting

The unit is designed for flush mounting by means of 4 fixing clamps, which are included at delivery. The two fixing clamps on each side are mounted on the top and bottom of the GC-1/ GC-1M box.



**Chapter 4 includes detailed information on switchboard cutout and unit dimensions.**

### Terminals

#### Low power signals

Terminals 1-18	
Terminals 1-3	CANbus (option H5)
Terminals 4-7	3 x multi-function inputs
Terminals 8-9	Speed pickup input
Terminals 10-11	Status relay output (micro-processor watchdog)
Terminals 12-18	Binary inputs

#### High power signals

Terminals 19-36	
Terminals 37-41	3-phase AC voltage measurement (voltage 50-480V AC)
Terminals 42,44,48	Not used, must not be connected
Terminals 43-47	3-phase AC voltage measurement (option B3)
Terminals 49-52	Relay outputs for gen. breaker and mains breaker (option B3)
Terminals 53-58	3 phase AC current measurement (1A or 5A)
Terminals 19-22	Not used, must not be connected
Terminals 23-25	Relay outputs
Terminals 26-27	DC power supply
Terminals 28-31	Not used
Terminals 32-36	Relay outputs

#### Unit rear view

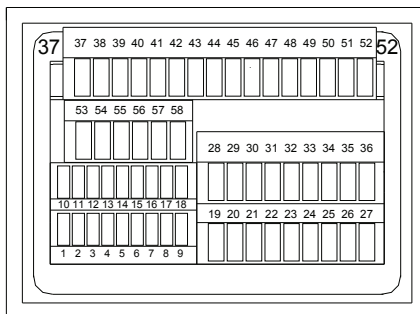

**The RJ11 connector for the PC connection interface box is placed on the side of the unit.**

## Terminal description



For the relay outputs the following terms will be used:

**NO** means Normally Open.

**NC** means Normally Closed.

**Com.** means common terminal for the individual relay.

Terminal	Technical data	Description
10...11	Status out. Contact ratings 1 A 30V DC/V AC	General status output for marine approvals
12	Common	Common for term. 13...18
13	Digital input	Start enable/configurable
14	Digital input	Remote start/configurable
15	Digital input	Charge alternator D+ (running)/configurable
16	Digital input	Overspeed/configurable
17	Digital input	Coolant temperature/configurable
18	Digital input	Oil pressure/configurable
23	Common	Common for term. 24, 25 and 32 and emergency stop*
24	Relay output 1. Contact ratings 2 A 30V DC/V AC	Horn. Function NO
25	Relay output 2. Contact ratings 2 A 30V DC/V AC	Alarm/configurable. Function NO
26	Power supply –	GND
27	Power supply +	6...36V DC
28...31	Not used	Note 23 and 31 are internally connected
32	Relay output 3. Contact ratings 2 A 30V DC/V AC	Start prepare/configurable. Function NO
33-34	Relay output 4. Contact ratings 8 A 30V DC/V AC	Run coil/stop coil/configurable. Function NO
35-36	Relay output 5. Contact ratings 8 A 30V DC/V AC	Starter (crank)/configurable. Function NO
<b>Multi-functional inputs</b>		
4	Common	Common for term. 5...7
5	VDO1/4..20mA/Binary input	Fuel level/configurable
6	VDO2/4..20mA/Binary input	Oil pressure/configurable
7	VDO3/4..20mA/Binary input	Water temp./configurable
<b>Optional CANbus #1 engine interface</b>		
1	Can-L	Can J1939 engine communication
2	Can-GND	
3	Can-H	
<b>Tacho RPM input</b>		
8	Tacho-GND	Magnetic pickup. PNP or NPN/tacho generator/charge alternator W terminal
9	Tacho input	
<b>3-phase generator voltage input</b>		
37	Gen. voltage L3	Generator voltage and frequency
38	Gen. neutral	
39	Gen. voltage L2	
40	Not used, must not be connected	
41	Gen. voltage L1	
42	Not used, must not be connected	
<b>3-phase generator current input</b>		
53	Gen. current L3, s1	Generator current
54	Gen. current L3, s2	
55	Gen. current L2, s1	
56	Gen. current L2, s2	
57	Gen. current L1, s1	
58	Gen. current L1, s2	
<b>Optional 3-phase mains voltage inputs</b>		
43	Mains voltage L3	
44	Not used, must not be connected	
45	Mains voltage L2	

46	Mains voltage neutral	
47	Mains voltage L1	
48	Not used, must not be connected	
Optional relays for closing gen. circuit breaker and mains circuit breaker		
49	Relay R1	Generator circuit breaker, function NO (normally open)
50	Relay R1	Not configurable
51	Relay R2	Mains circuit breaker, function NC (normally closed) Option B3
52	Relay R2	Not configurable

\* If terminal 23 is used for emergency stop, please see wiring diagram on page 12.

Terminal 23 emergency stop must be connected to +12/24V DC, because the other reference for the detection is internally wired to terminal 26 (negative). Besides deactivating the run coil output and activating the stop coil output, this terminal also disconnects the supply to relays 1-3. Sufficient care must be taken not to prevent a stop with the cut of supply, meaning that a stop coil output cannot be set to any of the relays 1 to 3. This function is turned OFF by default.

\*\*The status relay is the uP watchdog output. This relay is normally energised, and the switch is closed after power up. If the uP fails or the power is lost, the relay will de-energise and the switch will open. If the unit fails to start up at power up, then the relay switch will remain open.

The binary output functions are configurable via the PC utility software and can be configured to cover the following functions:

- Alarm/limit
- Engine running
- Auto mode
- Horn
- Idle speed
- Not used
- Start prepare
- Run coil
- Starter
- Stop coil
- External heater
- Stop coil (not acc. in start seq.)

It is possible to choose run coil on one relay and stop coil on another, thus supporting engines with double systems.

The multi-functional inputs can be configured to cover the following functions:

- VDO sensor input
- 4...20mA input
- Binary input with the possibility of cable supervision

Tacho RPM input can be configured to cover the following functions:

- Magnetic pickup (2-wire)
- W terminal on charger alternator\*
- NPN or PNP pickup

\* These RPM inputs require external equipment.

The generator voltage and current input can be configured to the following:

- Voltage 100...25000V primary
- Current 5...9000A primary

### Wiring

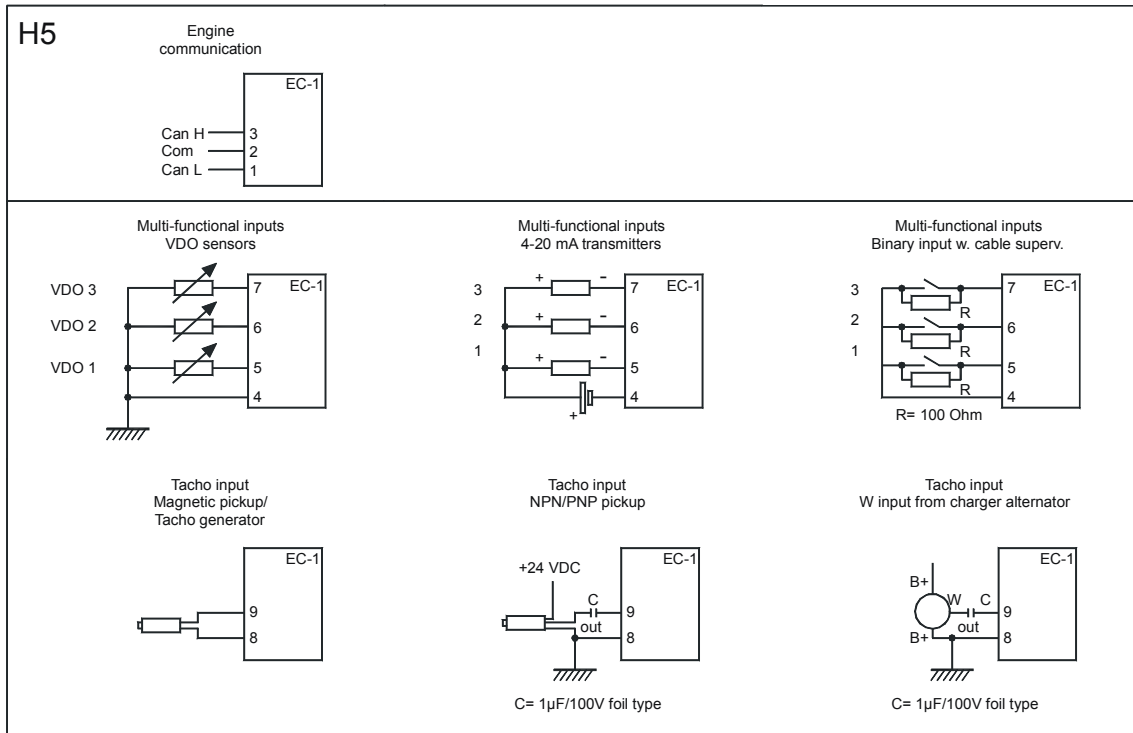
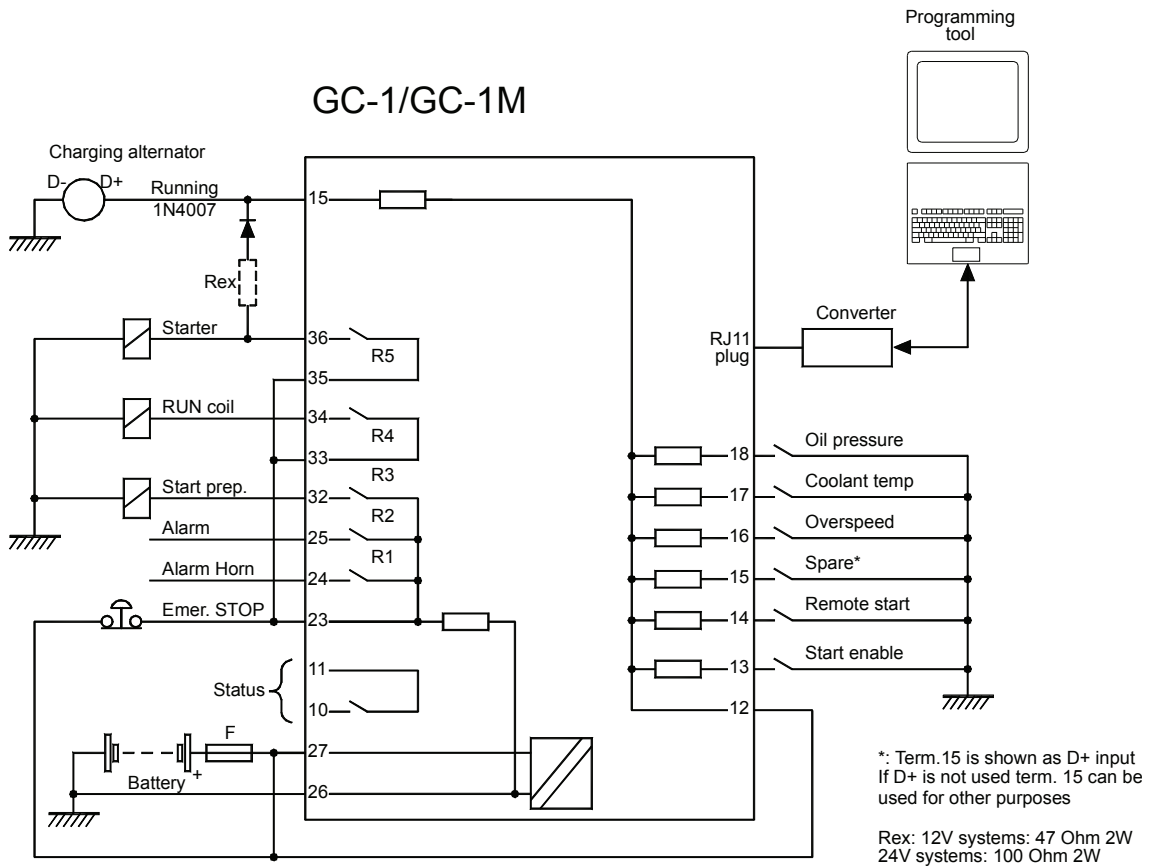



The illustrated configuration is the default factory setting. The use of the relays can be chosen freely.



It is important to protect the unit against damage caused by high voltages. Therefore, the fuse must not be more than 2A.

### Binary inputs

All binary inputs are 12/24V DC bi-directional optocoupler type. The typical wiring is illustrated below:

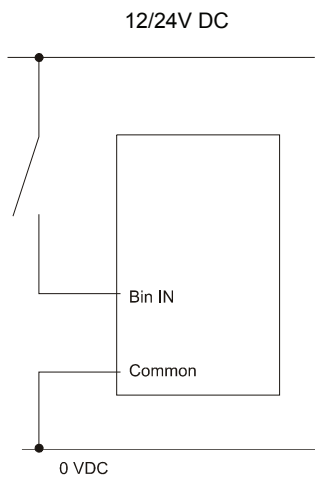

The binary inputs use fixed signals. Only the mode shift input and the test input (if the timer is used) use pulse signal.

## Charger alternator connections

The charger alternator can be connected in 2 different ways:

- 1) Using the D+ terminal connected to terminal 15
- 2) Using the W terminal connected to the RPM input



Usually only one of these possibilities is used.

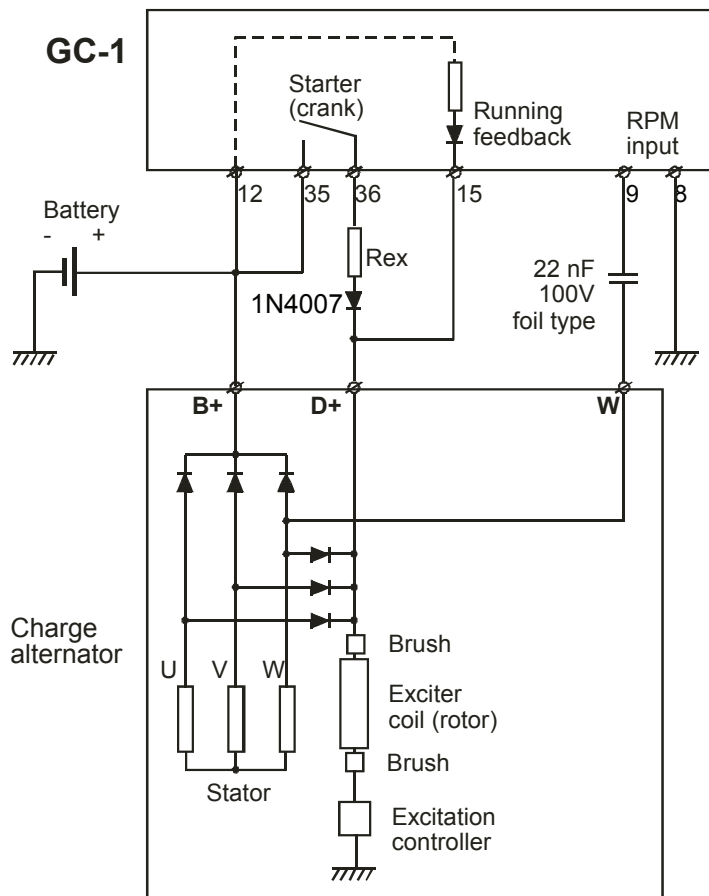

**Rex: Excitation resistor**

12V systems: 47Ω 2 W

24V systems: 100Ω 2 W

At standstill the battery + is connected to terminal 12 (common), and a current flows to terminal 15 and via the D+ input on the alternator to ground (battery -). When the starter is engaged (cranking), the battery will supply the D+ through the REX resistor, helping the alternator to excite. When the alternator starts to produce voltage (excitation OK), the speed of the alternator will be above running speed, and the voltage on term. 15 will rise to a value higher than the battery voltage and then interrupt the current flow through REX and activate the running feedback input. Engine is running.

### Connection of the 3-phase voltage and current

#### Wiring, AC interface

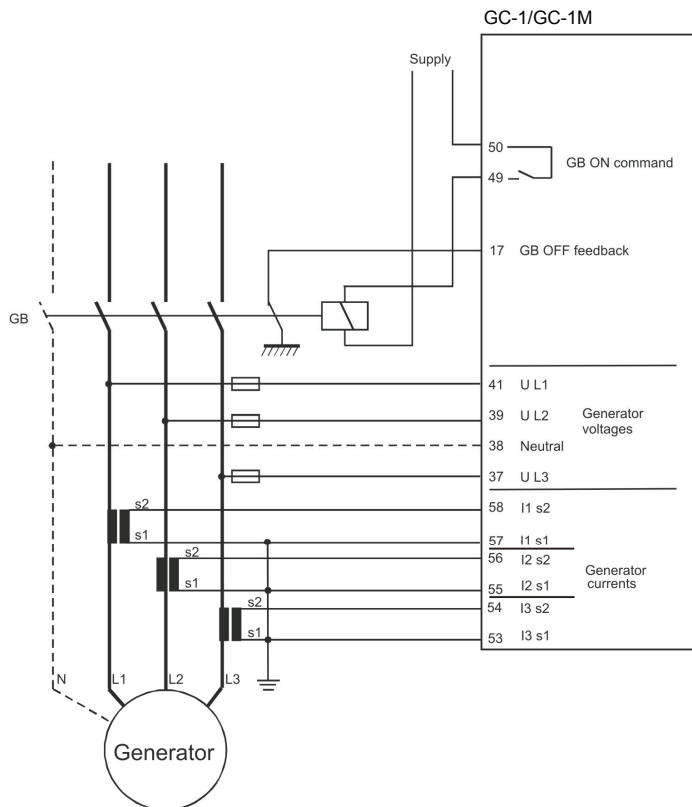

### Connection of the 1-phase voltage and current

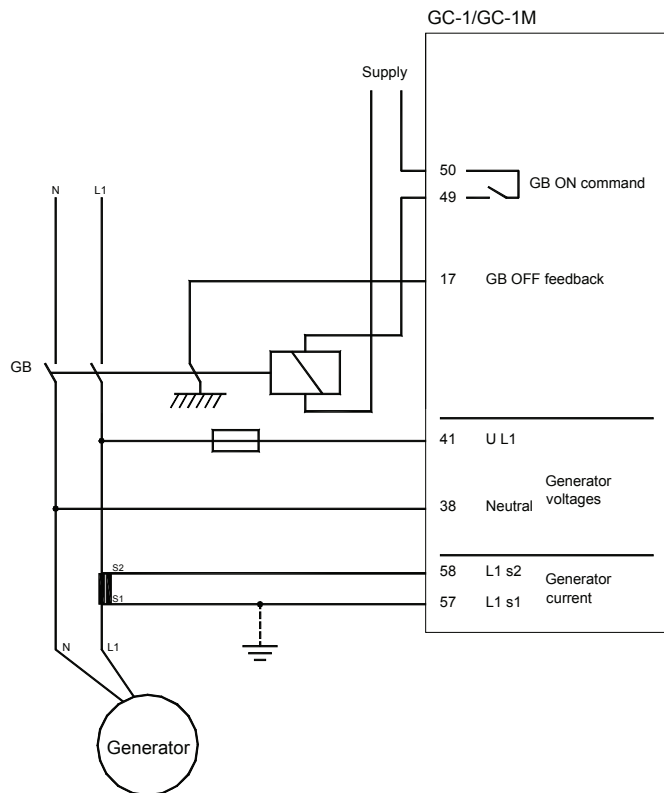

## Technical information

### Technical specifications

Accuracy:	Class 2.0 to EN 60688/IEC 688
Galvanic separation:	Between inputs and aux. power supply: 500V DC – 1 min.
Connections:	1.5 mm <sup>2</sup> multi-stranded
Operating temp.:	-25...70°C
Storage temp.:	-40...70°C
Measuring input voltage:	50...480V AC phase to phase
Load:	1.5MΩ
Measuring input current (In):	/1 or /5A meas. range 0...200%
Overload currents:	10A max. continuously 20A max. for 10 sec.
Load:	Max. 0.5VA per phase
Frequency:	30...70Hz
Analogue input:	From active transducer
Current:	4...20mA
Impedance:	50Ω Cable supervision: I < 3mA = fault Response times: 500ms
(From the setpoint is reached till the output is activated or the delay timer is started).	
VDO inputs:	Resistor inputs, internal 4V supply Cable supervision: R > 150Ω = Wire break Response times: 500ms
(From the setpoint is reached till the output is activated and the delay timer is started).	
Active binary inputs:	Dry contact inputs with cable supervision
Internal voltage:	4V DC
Impedance:	240Ω ~ 16mA
RPM input:	2.0...70V 10...10,000Hz
Passive binary in voltage:	Bi-directional optocoupler 8...36V DC
Relay outputs:	5 relays: 30V DC/AC 2A 2 relays: 30V DC/AC 8A 1 status relay: 24V DC 1A
Mounting:	Panel mounted



Size:	78 x 106mm
EMC/CE:	To EN 61000-6-1/2/3/4 SS4631503 (PL4) and IEC 255-3
Material:	All plastic materials are self-extinguishing according to UL94
Plug connections:	AC voltage inputs: 3.5 mm <sup>2</sup> multi-stranded Other: 1.5 mm <sup>2</sup> multi-stranded
PC connection:	RS232 converter box (option J5)
Approval:	CE & cUL (Listing pending) GC-1M only: Approved by major classification societies See <a href="http://www.deif.com">www.deif.com</a> for details
Weight:	Approx. 0.7 kg (1.5 lbs)

**Unit dimensions and panel cutout**

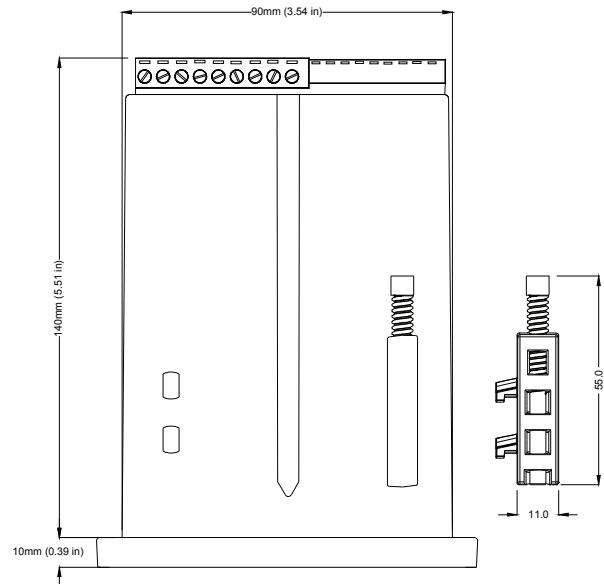
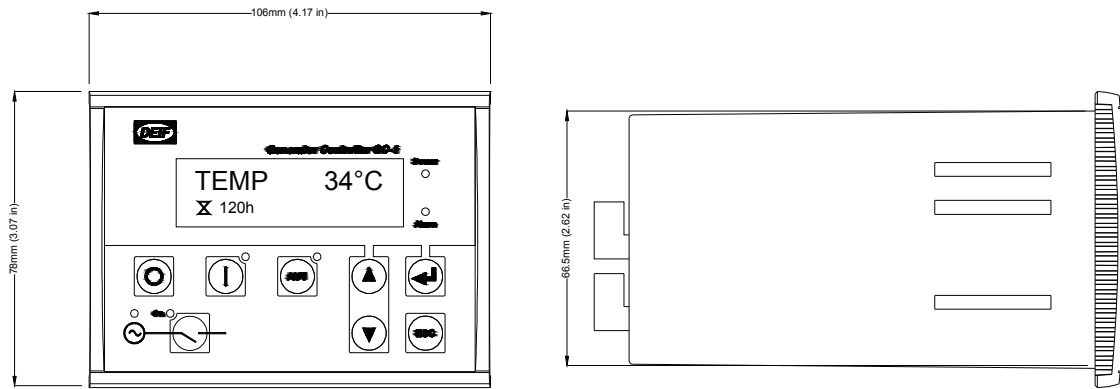

**Panel cutout**  
 H x W = 68 x 92 +0.3 mm  
 H x W = 2.68" x 3.62" +0.01"

## 5. Push-buttons, LEDs and display

This chapter deals with the display including the push-button and LED functions.

### Unit

<b>Front dimensions H x W</b>	78 x 106 mm (3.07" x 4.17")
<b>Unit depth</b>	150 mm (5.91")

#### Push-button functions

The push-buttons on the unit have the following functions:

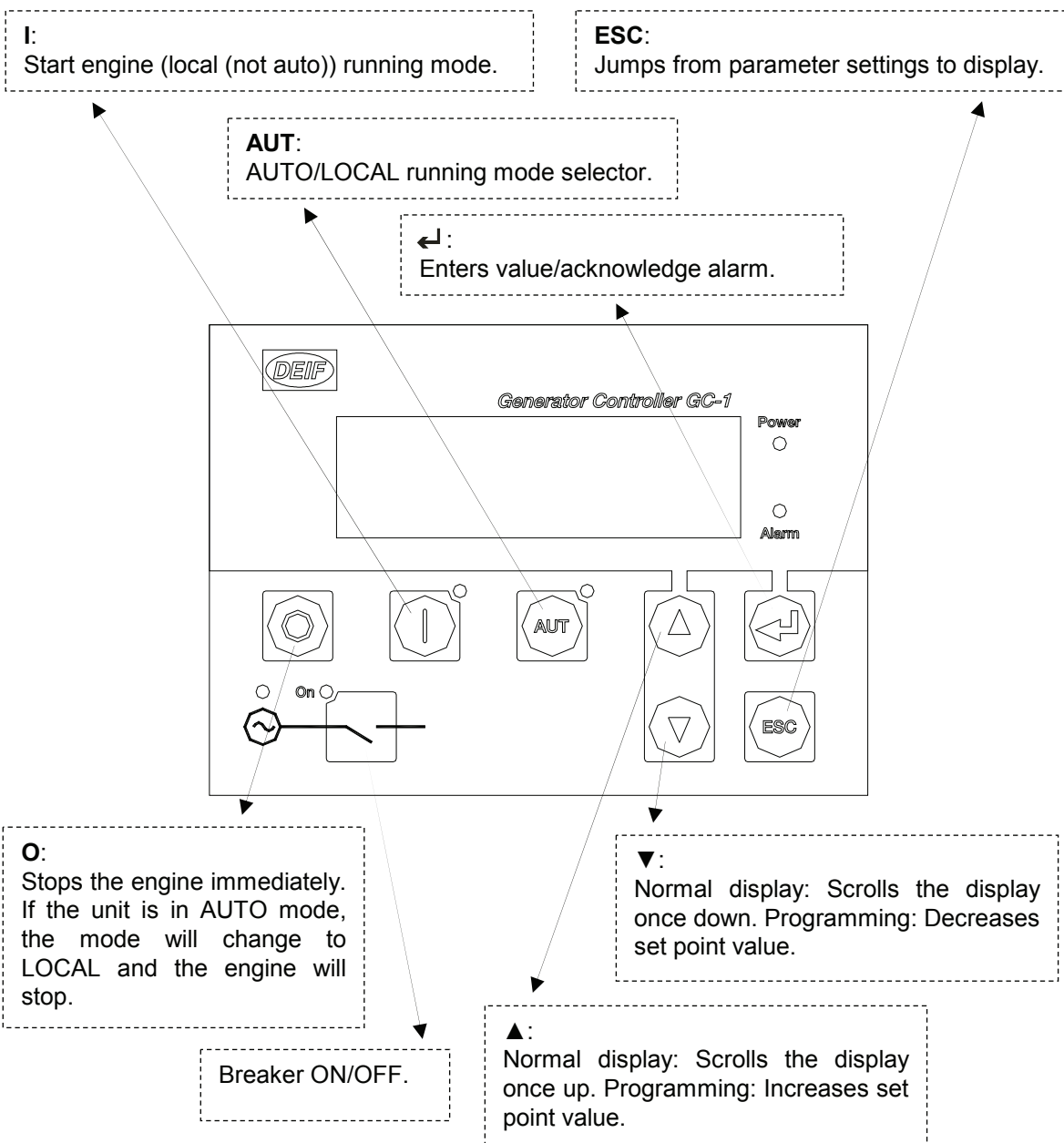

- I:** Start engine (local (not auto)) running mode.
- O:** Stops the engine instantaneously. If the unit is in AUTO mode, the mode will change to LOCAL and the engine will stop.
- AUT:** AUTO/LOCAL running mode selector.  
If the unit is in AUTO mode, and there is a loss of power supply, then the unit will always return to LOCAL/stop mode when the supply returns.
- ESC:** Jump from parameter settings to display.
- ▲:** Normal display: Scrolls the display once up. Programming: Increases setpoint value.
- ▼:** Normal display: Scrolls the display once down. Programming: Decreases setpoint value.
- ↵:** Enter value/acknowledge alarm.

**LED functions**

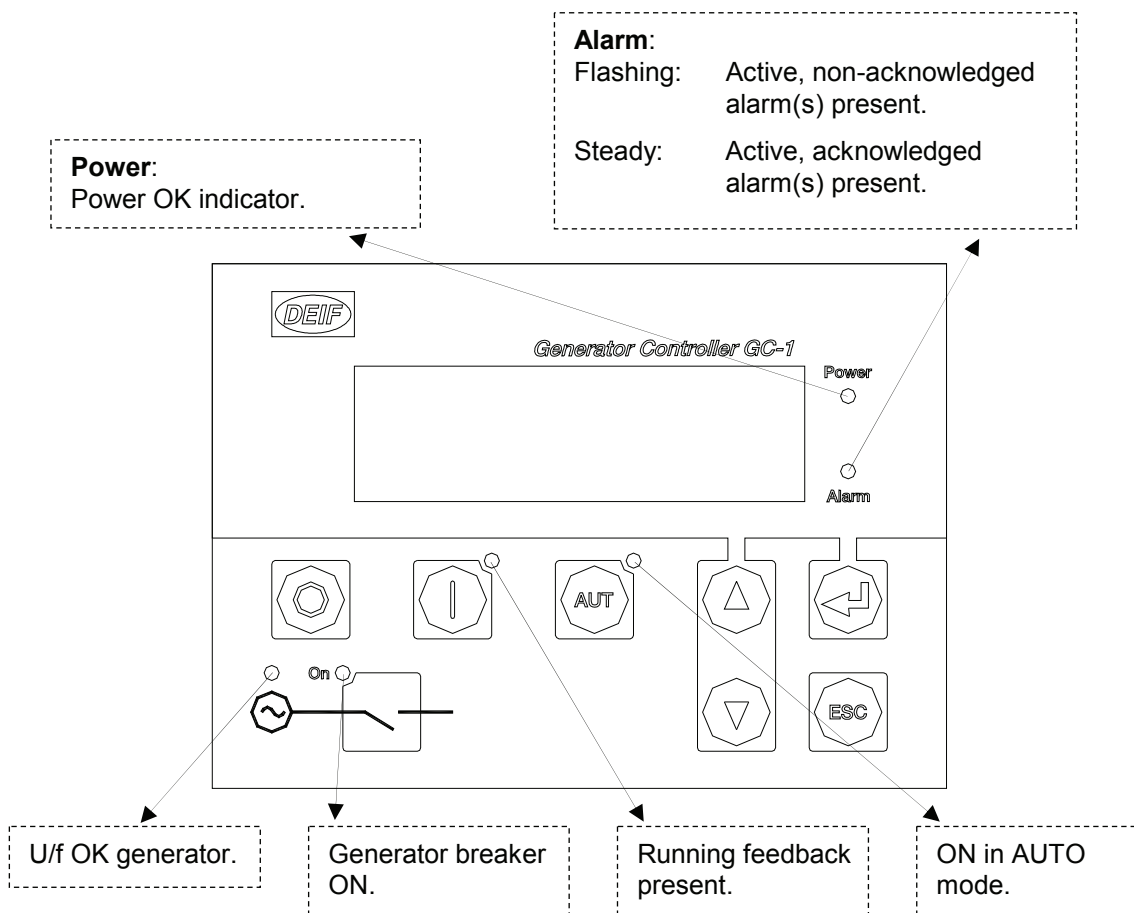

**Power:** Power OK indicator.

**Alarm:** Flashing: Active, non-acknowledged alarm(s) present.  
Steady: Active, acknowledged alarm(s) present.

## Display functions

The display indicates both readings and alarms. Illustrated below are examples with icons and English language.



Type and software version.

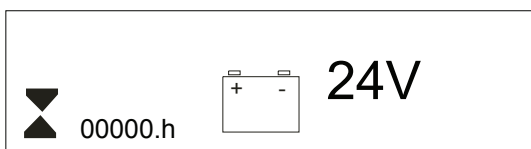

Battery voltage and running hours counter.



Service timer 1/2.



Press  $\leftarrow$  to enter the list of active alarms.

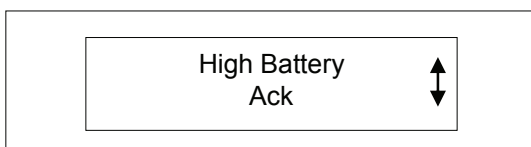

**Active alarm list.** The alarm list automatically pops up, when an alarm appears. When the arrow is present, more alarms are active. Press  $\Delta$  to scroll through the list. Exit the list by pressing ESC.



Press  $\leftarrow$  to enter the parameter setting.



Min. value

Actual value

Max. value

Parameter example: D+ delay setting. Use  $\blacktriangle$  or  $\blacktriangledown$  to scroll through the settings list. If change of settings is necessary, press  $\leftarrow$  and enter the password. Then use  $\blacktriangle$  or  $\blacktriangledown$  to change values. Use ESC to leave settings.

































**The available parameters depend on the set options. Some parameters can only be changed using the PC utility software (USW) for GC-1. The parameter list will automatically be abandoned, if no button is pressed during a 30 sec. period.**



















### Icon list







The list covers all available icons including those related to the engine communication.

	Warning list	Icon
1	Low oil pressure warning	
2	EIC temp. lube oil	
3	High coolant temp. warning	
4	High intercooler temp.	
5	Defect coolant level switch	
6	EMR warning	
7	JDEC warning	
8	Oil pressure	
9	Intake manifold	
10	Coolant temperature	
11	Fuel injection pump	
12	EI comm. error	
13	EIC warning	
14	Stop limit exceeded	
15	EMS warning	
16	Charge gen.	

	<b>Shutdown list</b>	<b>Icon</b>
17	Overspeed shutdown	
18	Low oil pressure shutdown	
19	EIC temp. lube oil	
20	Low coolant level shutdown	
21	High coolant temp. shutdown	
22	High oil temp. shutdown	
23	High charge air temp. shutdown	
24	High coolant temp. shutdown	
25	EMR shutdown	
26	JDEC shutdown	
27	Fuel temperature	
28	Fuel control valve	
29	ECU failure	
30	EIC shutdown	
31	EMS shutdown	

	<b>Analogue readings</b>	<b>Icon</b>
32	EIC speed	
33	EIC coolant temp.	
34	EIC oil pressure	
35	EIC faults	
36	EIC oil temp.	
37	EIC fuel temp.	
38	EIC boost pressure	
39	EIC air inlet temp.	
40	EIC coolant level	
41	EIC fuel rate	
42	EIC charge air pressure	
43	EIC charge air temp.	
44	EIC air inlet pressure	
45	EIC exhaust gas temp.	
46	EIC engine hours	
47	EIC oil f. diff. press.	
48	EIC battery voltage	
49	EIC fuel del. press.	



50	EIC oil level	
51	EIC crankcase press.	
52	EIC coolant pressure	
53	EIC water in. fuel	

## 6. Functional descriptions

This chapter includes functional descriptions for the unit's standard functions. Screen dumps and flow charts are used in order to simplify the information.

### Alarm function

The unit will detect and display individual alarms which are enabled. Furthermore, it is possible to activate relays for alarm purposes. The alarms can be configured to any of the available relay outputs. Each alarm function has two output settings, namely output A and output B.

Alarms can be acknowledged in one of two ways; either the binary input "alarm ack." (selectable to be one of the binary inputs 13, 14, 16, 17 and 18) is used, if this is configured for alarm acknowledge, or the select button on the display is used:

- The alarm acknowledge input acknowledges all present alarms, and the alarm LED will change from flashing to steady light.
- The display can be used in the alarm information window. The alarm information window displays one alarm at a time and the alarm state whether the alarm is acknowledged or not. If it is unacknowledged, then press  $\leftarrow$  to acknowledge it. Use  $\blacktriangle$  or  $\blacktriangledown$  push-buttons to scroll in the alarm list.

The alarm LED will be flashing, if unacknowledged alarms are present. The alarm relay will deactivate, when the alarm situation is reset and the alarm is acknowledged.

### Timer function

The delay settings are all of the definite time type, i.e. a setpoint and time is selected.

If the function is e.g. overspeed, the timer will be activated, if the setpoint is exceeded. If the RPM value goes below the setpoint value before the timer runs out, then the timer will be stopped and reset.

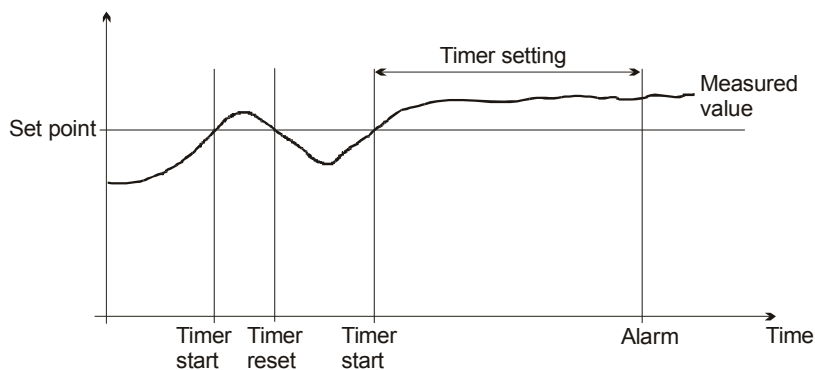

When the timer runs out and the alarm is present, the output is activated.

### Utility software input configuration

It is possible to configure the inputs indicated in the table. The unit has a number of passive binary inputs (input terminals 13-18).

Input function	Comment
Test run	Configurable
Nom. setting 3 1 ph	Configurable
Remote stop (Pulse)	Configurable
Remote start (Pulse)	Configurable
Alarm acknowledge	Configurable
Parameter shift (secondary parameters)	Configurable
Start enable (OFF = start blocked)	Configurable
GB Pos on	Configurable
GB Pos off	Configurable
MB Pos on	Configurable (option B3)
MB Pos off	Configurable (option B3)
Access lock	Configurable
Mode shift (auto/manual)	Configurable
Fire pump	Configurable
Remote start/stop	Configurable
D+ (term. 15 only)	Configurable
Digital inputs no. 1....6 used as alarms	Configurable
Idle speed	Configurable
Inhibit EI alarms	Configurable (option H5)

#### Input function description

##### 1. Test

When activating this input, a virtual mains failure is created. This means that a mains failure sequence is carried out. When the input is deactivated, the controller will return to mains supply. If the test timer is enabled (set higher than 0), the timer will start running when the input has been activated and deactivated. This means that the input can be used as a pulse input when the test timer is enabled. This function requires option B3.

##### 2. Nom. setting 3 1 ph

Activates the third set of nominal settings, if the parameter 4035 is set to binary input. When deactivated, the controller returns to Nom. setting 1.

##### 3. Remote stop (Pulse)

Activating this input will stop the gen-set. Pulse must be longer than 500ms. (Auto mode only).

##### 4. Remote start (Pulse)

Activating this input will start the gen-set. Pulse must be longer than 500ms. (Auto mode only).

##### 5. Alarm acknowledge

Acknowledges all present alarms.

##### 6. Parameter shift

Selection of this input will make the unit use the secondary set of parameters (SP2).

##### 7. Start enable

This input must be activated to start the engine.



**Start enable is start control only, i.e. if removed when the engine is running, the engine keeps on running.**

**8. GB Pos on**

When this input is activated, the controller sees the generator breaker as closed. If the GB on and the off feedback are on or off simultaneously, a GB position failure is displayed.

**9. GB Pos off**

When this input is activated, the controller sees the generator breaker as open. If the GB on and the off feedback are on or off simultaneously, a GB position failure is displayed.

**10. MB Pos on**

When this input is activated, the controller sees the generator breaker as open. If the MB on and the off feedback are on or off simultaneously, an MB position failure is displayed.

**11. MB Pos off**

When this input is activated, the controller sees the generator breaker as open. If the MB on and the off feedback are on or off simultaneously, an MB position failure is displayed.

**12. Access lock**

Activating the access lock input deactivates the control push-buttons on the display. It will only be possible to view measurements, alarms and the log.

**13. Mode shift**

Selection between manual and auto running. The mode is changed every time the input is activated (pulse input).

**14. Fire pump (shutdown override)**

Deactivates all protection functions except overspeed and emergency stop protection.

**15. Remote start stop input**

Activating this input will start the gen-set. Deactivating it will stop the gen-set after cool down (auto mode only).

**16. D+ (terminal 15 only)**

This input is used as a running indication of the engine. When the input is activated, the start relay is deactivated.

**17. Digital inputs 1...6**

These inputs are configurable as alarm inputs. For terminal 15 input for running feedback from charge generator +D terminal is also possible. (Run when charger U > battery voltage).

**18. Idle speed**

Activating the idle speed input holds the engine at idle speed for as long as it is set.

**19. Inhibit EI alarms**

When this input is active, it will inhibit all engine interface (option H5) alarms.

**Configuration**

The digital inputs are configured via the utility software (USW).

Use this button to upload the menu.

Remember to write the settings to the unit.

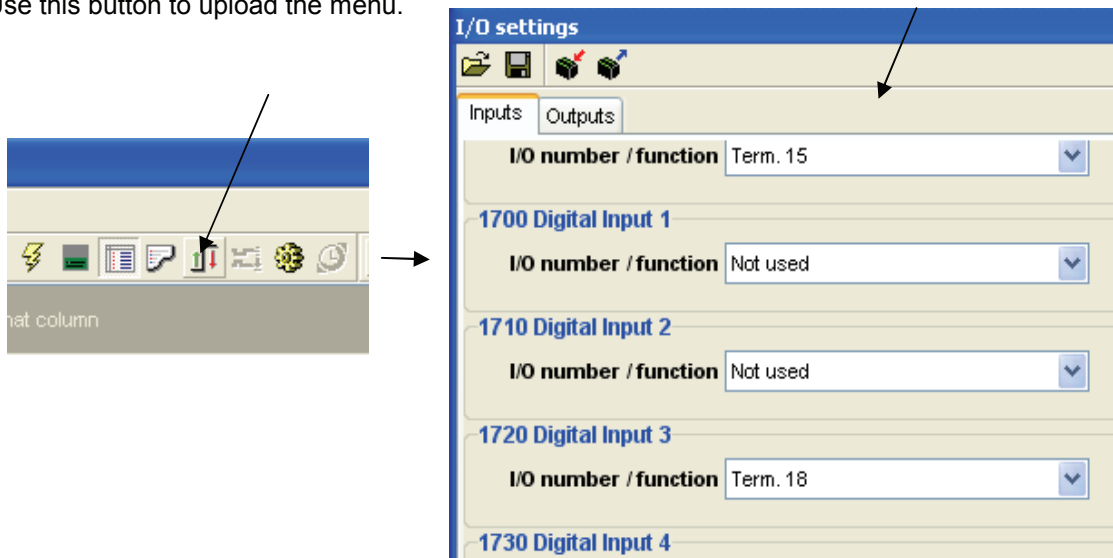

The individual I/O number and the function are now selected. In the example below 'Digital input 3' is chosen, and a terminal number must be assigned to the input. If the input is used as alarm input, then the name can be changed to the relevant name selected from the predefined list below:

First, 'Digital input 3' is selected from parameter no: **1700-1750 Digital input term. 13-18, no cable supervision**

Then name the input from the list below.

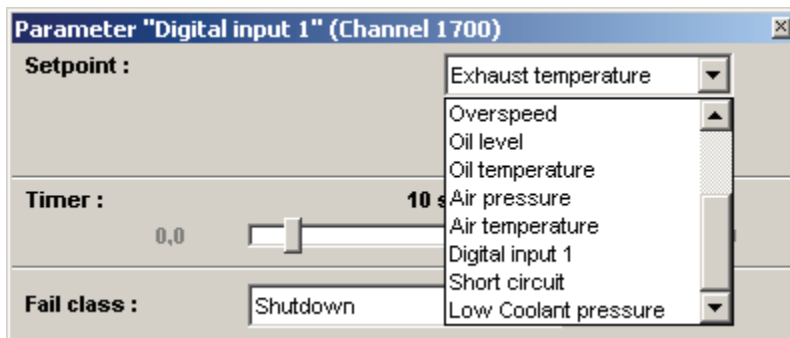

Complete the input settings and select the appropriate fail class and outputs. The outputs A and B can be used to activate one or two of the configurable relay outputs. If the relay function is set as a limit relay, no warning pop-up will be shown in the display. The relay 0 is a virtual relay, so both output A and B must be set to limit relays if no warning in the display is wanted.

Parameter "Digital input 3" (Channel 1720)

Setpoint : Exhaust temperature

Timer : 0,0 10 sec 100,0

Fail class : Shutdown

Output A : Output 0

Output B : Output 0

Password level : Customer

Enabled : OFF

High Alarm

Inverse proportional

Cable supervision

Commissioning

Actual value : 0

Time elapsed : 0 sec (0 %)

0 sec 10 sec

Write OK Cancel

Remember to activate the function by changing OFF to ON or RUN. If RUN is selected, then the alarm will only be active, when the engine is running.

If the High Alarm is set, then the alarm will be registered upon a closing contact. If the High Alarm is not set, then the alarm will be registered upon an opening contact.

After configuration of the input parameter it is possible to assign a relay. Use the dialog box below for configuration of the output relay.

Remember to write the settings to the controller before closing the dialog box.

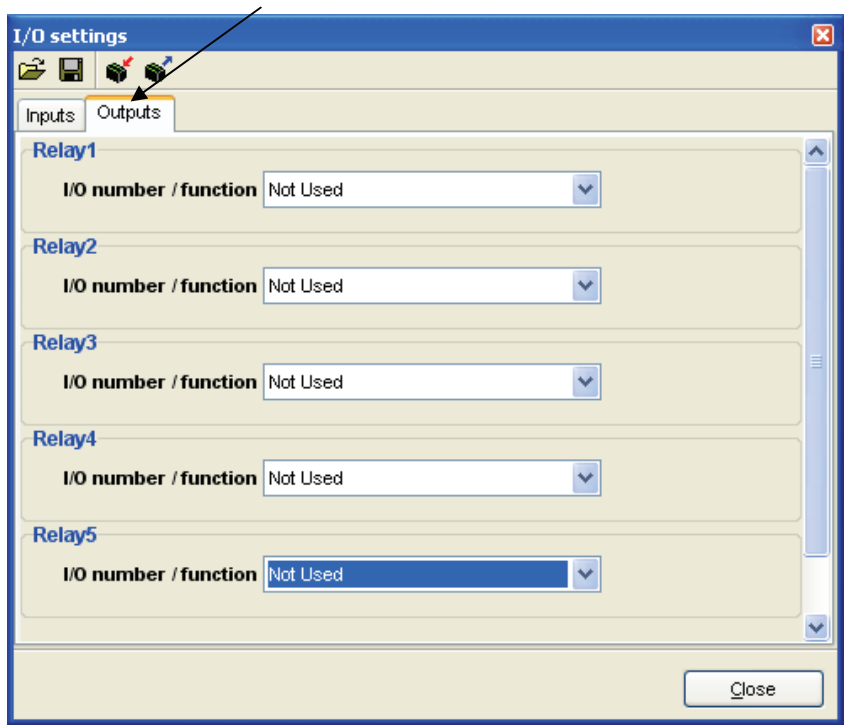

Select the language in the language dialog box.

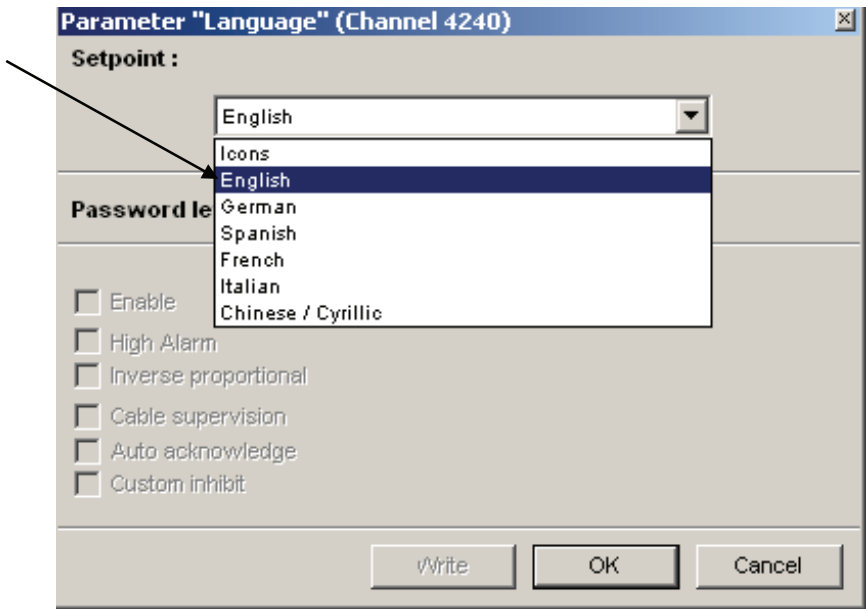

Please notice that the language used in the USW will still be English, even if the language is changed. The selection Chinese/Cyrillic is dependent on the software version. The software contains either Chinese or Cyrillic. This is selected when the GC-1 is ordered, or upon application software download from [www.deif.com](http://www.deif.com).

### Fail class

All the activated alarms of the controller must be configured with a fail class. The fail classes define the category of the alarms and the subsequent action of the alarm.

Four different fail classes are available:

Fail class	Action						
	Alarm horn relay*	Alarm display	Block engine start	Open gen. breaker (if present)	Stop generator	Cool-down	Shutdown
0 Warning	X	X					
1 Trip of GB	X	X		X			
2 Trip and stop	X	X	x	X	X	X	
3 Shutdown	X	X	x	X	X		X

\* When alarm horn relay output is selected active.

### Fail class configuration

The fail class can be selected for each alarm function via the USW (PC software). To change the fail class via the PC software, the alarm function to be configured must be selected. Select the desired fail class in the fail class roll down panel.

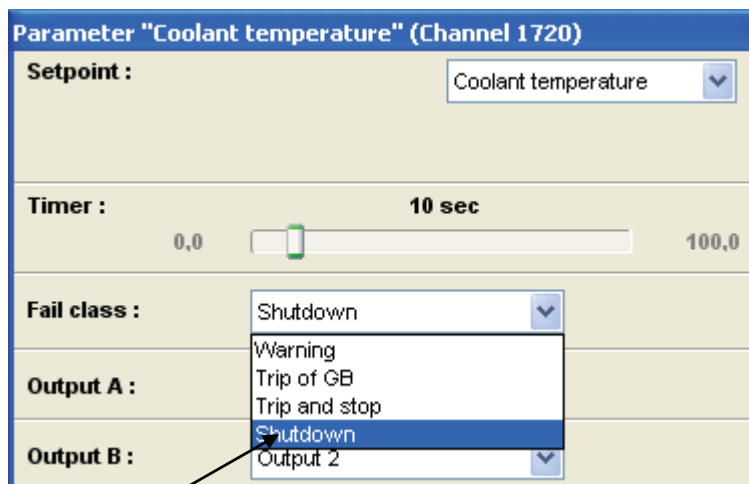

The fail class roll down panel is activated, and the individual functions are ready for selection.

### Service timers

The controller can monitor two different maintenance intervals:

- Service timer 1
- Service timer 2

Both timers operate on either:

1. Running hours (counting up), or
2. Elapsed time (counting down)

When the adjusted time for elapsed timer expires, the controller will display an alarm. Activating the alarm acknowledge resets this alarm. From the alarm to the time of acknowledge, the timer counts on. When acknowledging the alarm the timers will be reset, and a new service timer alarm will only reoccur after the adjusted time has elapsed. The running hours and elapsed time is counting, when the running feedback is present.



## VDO sensors



In the following description of the VDO inputs the order will be input 2, 3, 1. In this way we are using the same order as in the PC utility software.

There are three VDO inputs in the unit. The inputs have different functions due to the fact that the hardware design is able to cover several VDO types.



All VDO inputs have a general accuracy of 2%.

VDO input 2: Oil pressure - max. 240 Ohm  
 VDO input 3: Cooling water temperature - max. 2500 Ohm  
 VDO input 1: Fuel level sensor - max. 180 Ohm

### VDO input 2, oil pressure

		VDO sensor type		
Pressure		Type 1	Type 2	Type 3
Bar	Psi	$\Omega$	$\Omega$	$\Omega$
0	0	10.0	10.0	Configurable
0.5	7	27.2		
1.0	15	44.9		
1.5	22	62.9		
2.0	29	81.0	51.5	
2.5	36	99.2		
3.0	44	117.1	71.0	
3.5	51	134.7		
4.0	58	151.9	89.6	
4.5	65	168.3		
5.0	73	184.0	107.3	
6.0	87		124.3	
7.0	102			
8.0	116		155.7	
9.0	131			
10.0	145		184.0	



Type 3 is fully configurable with 8 points in the range 0-240 $\Omega$ . The parameter settings can be found in menu 5000.

The PC utility software setting looks like this:

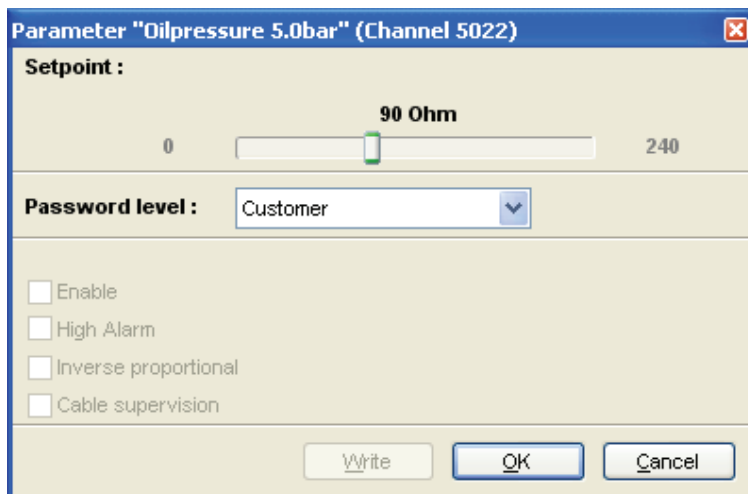

**i** 8 settings are available from 0-2,5-5-6-7-8-9-10 bar.

**VDO input 3, cooling water temperature**

		VDO sensor type			
Temperature		Type 1	Type 2	Type 3	Type 4
°C	°F	Ω	Ω	Ω	Ω
40	104	291.5	480.7	69.3	Configurable
50	122				
60	140	134.0	222.5	36.0	
70	158	97.1		27.9	
80	176	70.1	113.2	19.8	
90	184	51.2	83.2	15.8	
100	212	38.5	62.4	11.7	
110	230	29.1	47.6	9.5	
120	248	22.4		7.4	
130	266		28.9		
140	284				
150	302		18.2		

**i** Type 4 is fully configurable with 8 points in the range 0-480Ω with the MK I hardware.  
**i** Type 4 is fully configurable with 8 points in the range 0-2500Ω with the MK II hardware.

**i** The type of hardware can be identified on the label on the side of the GC-1.

The PC utility software setting looks like this:

Parameter "Water temp 60 C" (Channel 5032)

Setpoint :

0 120 Ohm 2500

Password level : Customer

Enable  
 High Alarm  
 Inverse proportional  
 Cable supervision  
 Auto acknowledge  
 Custom inhibit

Write OK Cancel



8 settings are available from 0-40-60-80-90-100-120-150°.

#### VDO input 1, fuel level

VDO sensor type	
Type 1	
Value	Resistance
0%	78.8Ω
100%	1.6Ω

VDO sensor type	
Type 2	
Value	Resistance
0%	3Ω
100%	180Ω

VDO sensor type	
Type 3	
Value	Resistance
%	Configurable
0	
10	
20	
30	
40	
50	
60	
70	
80	
90	
100	



Type 3 is fully configurable with 8 points in the range 0-180Ω.

The PC utility software setting looks like this:

Parameter "Fuel level 40%" (Channel 5011)

Setpoint :

0 20 Ohm 180

Password level : Customer

Enable

High Alarm

Inverse proportional

Cable supervision

Write OK Cancel



**8 settings are available from 0-40-50-60-70-80-90-100%.**

### VDO usage

The VDO inputs are used as alarm inputs and can be configured in the following menus.

VDO input 2: Lubricating oil pressure - alarm settings in menus:

**1350 VDO oil press input 2.1**  
**1360 VDO oil press input 2.2**

VDO input 3: Cooling water temperature - alarm settings in menus:

**1370 VDO water temp input 3.1**  
**1380 VDO water temp input 3.2**

VDO input 1: Fuel level switch - alarm settings in menus:

**1390 VDO fuel level input 1.1**  
**1400 VDO fuel level input 1.2**  
**1410 VDO fuel level input 1.3**

In addition, VDO input 1 is also used for the fuel logic function.

### Illustration of configurable inputs

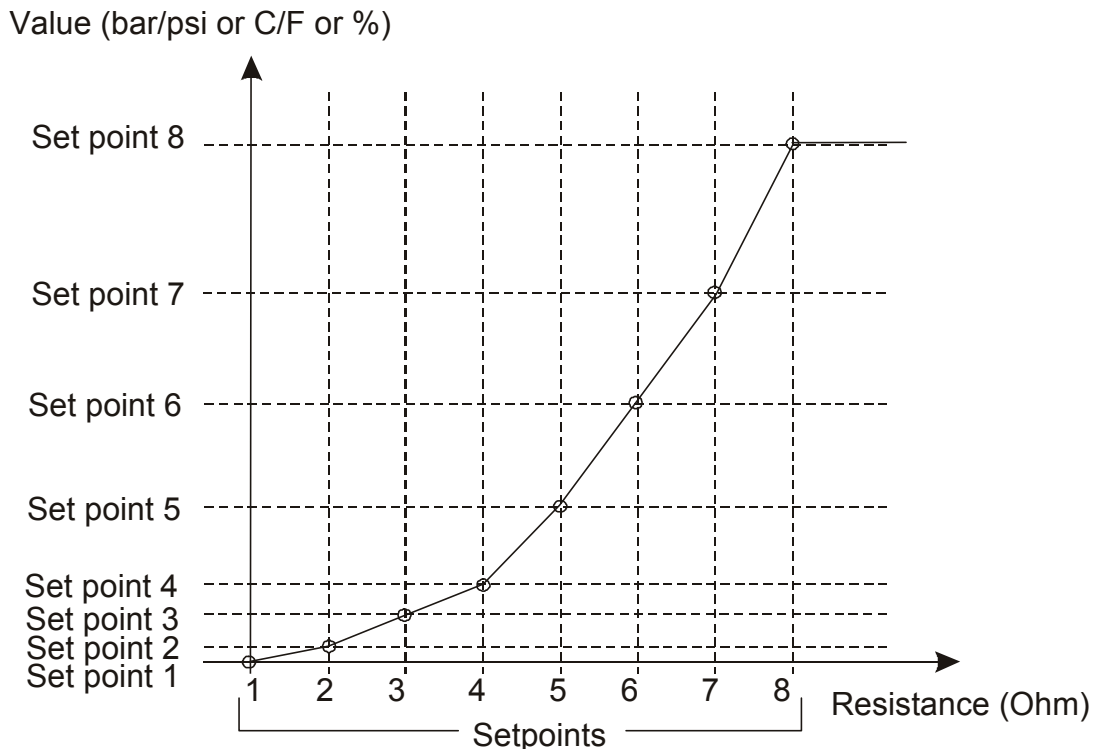

#### Configuration

The 8 curve settings for the configurable VDO inputs cannot be changed in the display, but **only** in the PC utility software.

#### Binary inputs with cable supervision

The binary inputs are based on the VDO inputs, i.e. if a VDO input is selected, the binary input cannot be chosen, and vice versa. When selected as multi-functional inputs, the 3 VDO inputs can be changed to binary inputs with cable supervision. The cable supervision is selectable (ON/OFF) and based on the VDO inputs using a 100 Ohm resistor across the monitored switch. The resulting function is:

$R < 20 \text{ Ohm} =$	Switch closed
$30 < R < 140 \text{ Ohm} =$	Switch open, cable OK
$150 \text{ Ohm} < R =$	Wire break

The setting of the alarm input is carried out in the same way as the setting of the standard binary input. So the texts are not 100% configurable but have to be chosen from a preconfigured text list.

#### Fuel pump logic

The fuel pump logic is used in order to start and stop the fuel supply pump to maintain the fuel level in the service tank at predefined levels. The start and stop limits are detected from the VDO 1 input.

**Start level, factory setting at 20% (S2 - 1880 Fuel pump logic)**

**Stop level, factory setting at 80% (S3 - 1880 Fuel pump logic)**



The fuel pump relay is an NO relay and is configured to relay 2 by default. This configuration cannot be changed. If other alarm functions have been configured to relay 2, and the fuel logic is activated, then a *relay channel error* alarm will occur.

- Start level, relay 2 activates
- Stop level, relay 2 deactivates

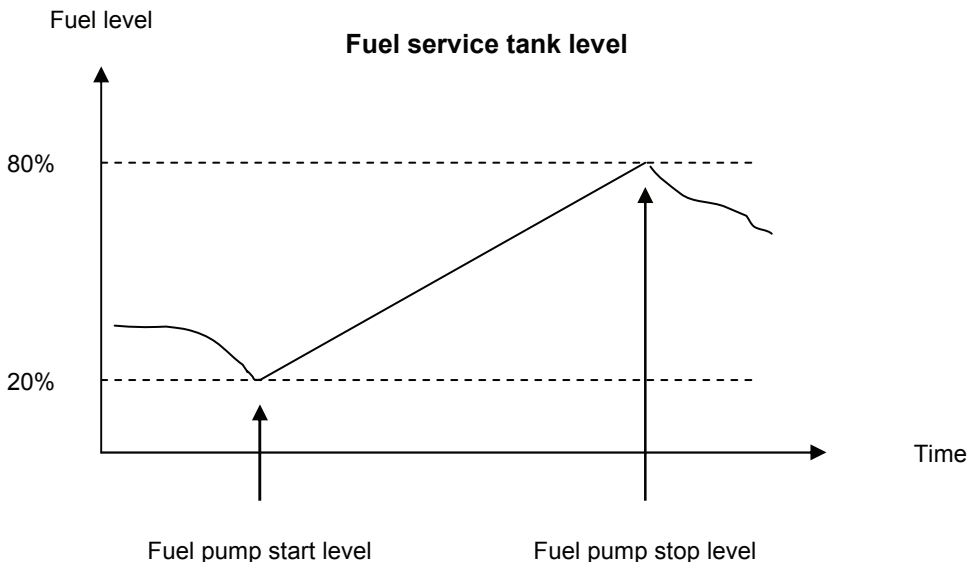

**Fuel fill check**

The fuel pump logic includes a *fuel fill check* function.

When the fuel pump is running, the fuel level must increase with 4% within the *fuel fill check* timer. This timer is adjusted in 1880 Fuel pump logic, but the level of increase cannot be changed. If the fuel level does not increase at least 4% within the adjusted delay time, then the fuel pump relay will deactivate, and a *fuel fill alarm* occurs.

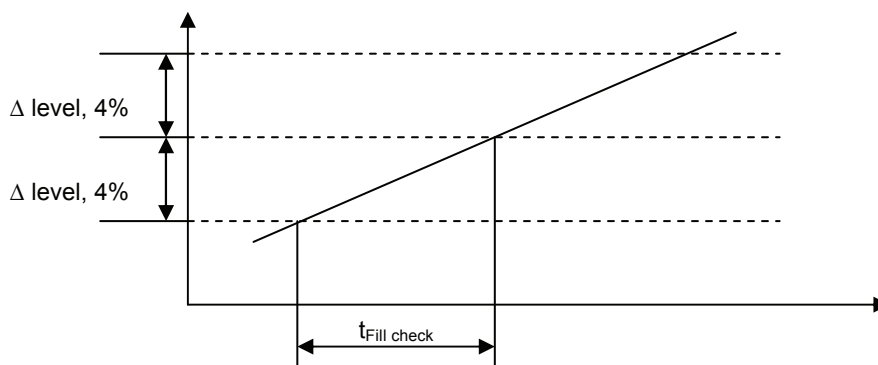

### 4-20mA inputs

The 4-20mA setting can *only* be set in the PC utility software.

Settings:

- Scale top point value (click on the '...').
- Name: Freely configurable (click on the '...').
- Unit: E.g. bar, mbar, C, F, %.
- Scale low point value.

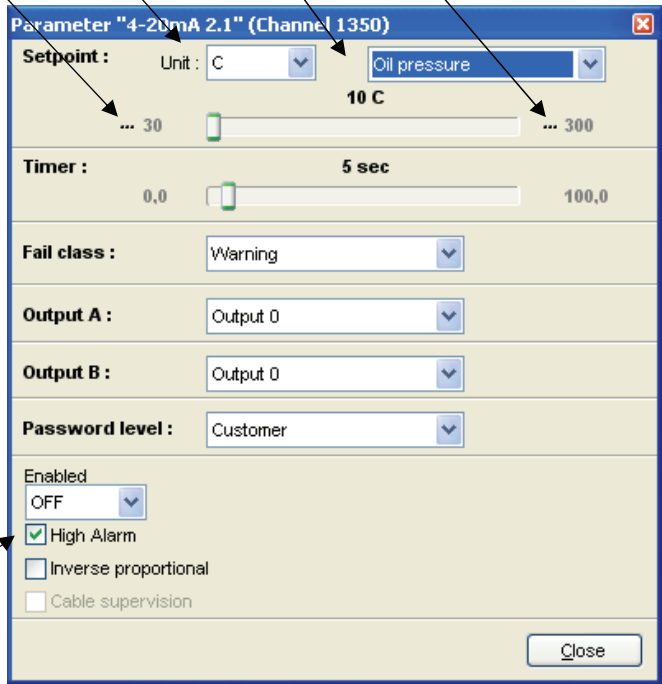

Tick boxes: Select the needed function.

### RPM inputs

#### Charger alternator connections

This schematic diagram shows the basic way the charge alternator and the controller can cooperate.

Normally only one of the inputs *running feedback* or *RPM* is used.

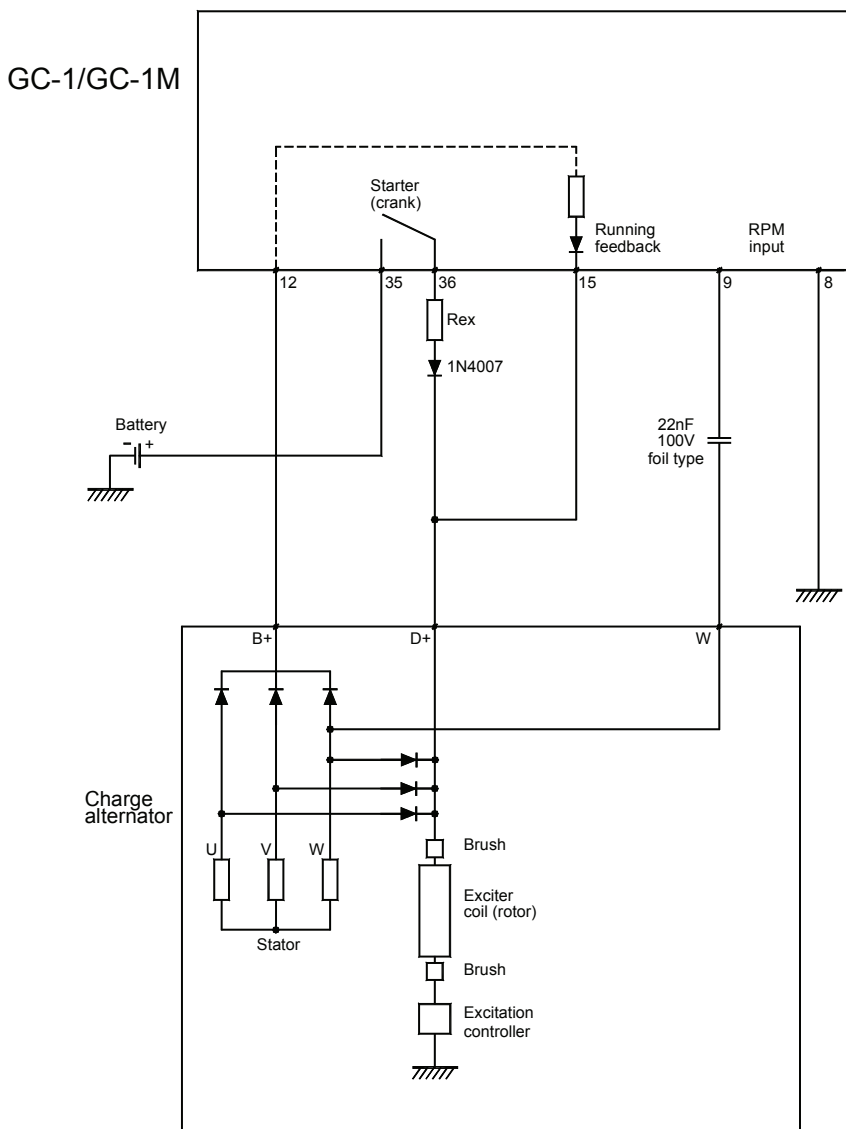

Rex: Excitation resistor: 12V systems: 47Ω 2 W  
 24V systems: 100Ω 2 W

#### Charger alternator terminal W

The terminal W output is an AC voltage. A 22 nF foil type capacitor must be inserted in order to eliminate the DC component.

#### Magnetic pickup

The 2-wire magnetic pickup can be connected directly to terminals 8-9.



**NPN transistor output pickup**

Since the NPN output is a frequency modulated DC pulse signal, a few external components are needed in order to eliminate the DC component.

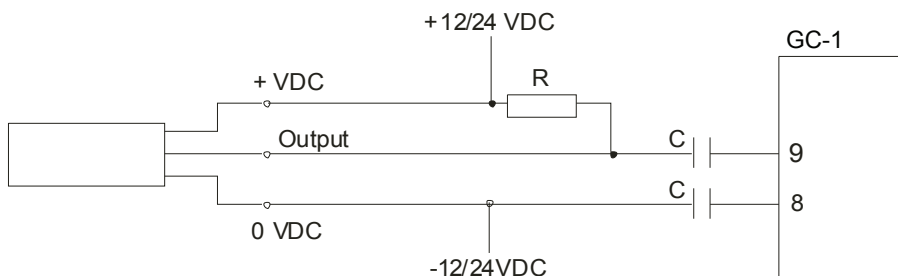

C = 22 nF, 100V foil type  
 R = 1200Ω (24V DC), 600Ω (12V DC)

**PNP transistor output pickup**

Since the PNP output is a frequency modulated DC pulse signal, a few external components are needed in order to eliminate the DC component.

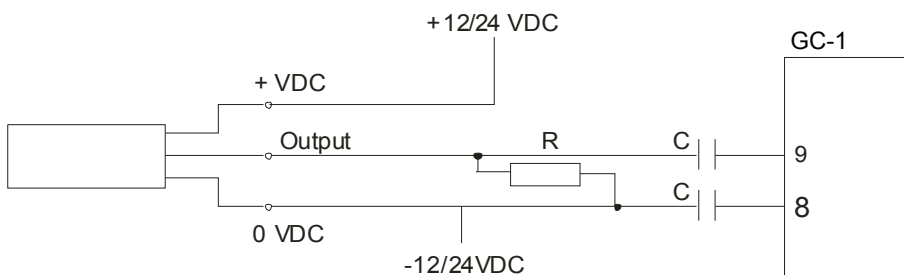

C = 22 nF, 100V foil type  
 R = 1200Ω (24V DC), 600Ω (12V DC)

## Generator breaker control

### Breaker closing

Since the generator is assumed to run alone (single generator island), the breaker will close immediately when the Hz/V OK status is reached (AUTO), or if the breaker button is activated (LOCAL). In LOCAL mode the breaker can be closed by pressing the button on the front of the controller, when Hz/V is OK.

### Relay output control

The generator breaker is assumed to be a contactor, i.e. the relay output is steady ON when the breaker is closed, and steady OFF when the breaker is open. It is not possible to have 2 pulse outputs for a motorized breaker (ON and OFF).

### Breaker trip control

Any alarm selected to have the fail class *Trip* or *Shutdown* will automatically open the breaker control relay. This is done automatically. If the breaker is closed when the idle speed is activated, a breaker out signal will be transmitted.

### Breaker ON/OFF feedback

As default there is no feedback for breaker ON or OFF. The breaker position LED is paralleled to the breaker control relay output. It is possible, however, to select a binary input to be breaker ON feedback and/or an OFF feedback. This is done via an extra selection in the input settings of the PC utility software. This extra input is called *GB Pos on* or *GB Pos off*.

This icon activates the inputs settings:



If the input *Breaker ON feedback* is selected, then the input must be connected and activated, if the breaker is ON. The reason is that a *Breaker close failure* alarm will appear, if the breaker control relay is activated without the binary input. Also, if the breaker control relay is OFF and the binary input is ON, then a *Breaker open failure* alarm will appear.

These alarms are fixed with the status *Warning*.

### Engine temperature controlled GB closing

This function can be used, if it is recommendable that the engine cooling water temperature must be over a certain temperature before the engine is loaded. In the parameter 4470 it is possible to set the temperature that the cooling water temperature must exceed, before the generator breaker is closed.

The function is also enabled/disabled in parameter 4470. An engine heating message is displayed, until the engine cooling water temperature has reached the setpoint in parameter 4470.

The engine cooling water temperature sensor must be selected to be a VDO sensor to make the function work. If the option B3 (AMF logic) is enabled, this function will also work upon a mains failure.

### The GC-1/GC-1M in IT networks

The controller can easily be used in an IT network, meaning a generator without a neutral connection, but some precautions must be taken. Due to the construction of the controller, the frequency measurement can be interrupted, if a ground loop to phase L1 is established due to a ground fault in the installation. If the frequency measurement is interrupted, the warning Ph L1-0 fault is displayed.

If it is recommendable that the generator does not shut down in case of an earth failure, the alarms underfrequency and Hz/V failure must be set to the fail class warning.

When the option B3 AMF is enabled, it is also recommendable to set the parameter 4435 Main fail f on/off to off. This is to avoid a false mains failure detection due to ground failure.

In the IT network there is no neutral connection, so the voltage measurement phase neutral is not present. This reading can therefore be disabled in the parameter 4055.

The class 2.0 voltage measuring cannot be maintained, when an earth fault is present.



**For the GC-1 to work properly in an IT network, the GC-1 must have a hardware version Mark II. This is indicated on the side of the GC-1.**

## GSM communication

GSM communication can be used for 2 purposes:

1. Sending SMS alarm messages to up to 5 different mobile phones. The messages will be sent in clear text, representing the alarm in question (e.g. "Overspeed").
2. Communicate with the controller PC utility software.

Connection:

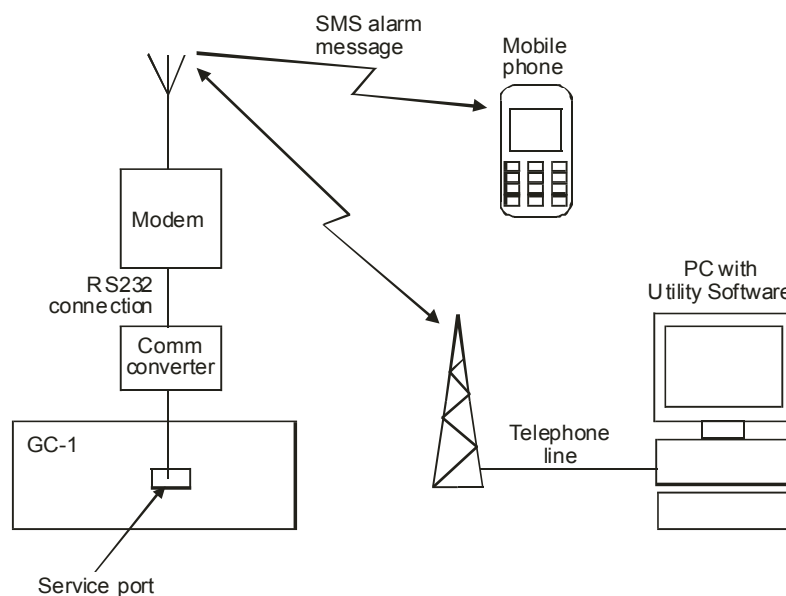

The connection is based on an RS232 connection to a GSM modem via the service port on the controller. Since the connection on the controller is a TTL communication, the interface box PI-1 (option J5) is needed to convert the signals to RS232. The PI-1 connects via a cable with SUB-D 9-pin female connector on the modem side.



DEIF A/S recommends using MOXA OnCell G2150I, Wavecom WMOD2 or Westermo GDW-11 terminal, as the application has been tested with these terminals. The easiest way to get the modem is to purchase it through a local dealer. The SIM card needed comes from your local mobile net provider. Setting the PIN code in the modem itself is easiest done by mounting the SIM card in a mobile phone and changing the PIN code there. The SIM card will remember the PIN code when it is installed in the modem.



**Some modem manufacturers recommend a short power interruption (30 sec.) once a day to prevent lock-up of the modem. This is easiest done using a 24 hour watch.**

Should an alarm occur during the interruption, the Multi-line unit will re-transmit it when the modem starts again, so no messages are lost.

## Utility software connection via modem

-  If a PC utility software connection is required, then the SIM card must support data transfer. Contact your GSM provider for details.
-  When ASCII mode is selected, the USW must also be set to ASCII mode. This selection is not needed, if the modem is used for SMS messages only.

### PC utility software

Press the application settings push-button.



The settings dialog box appears:

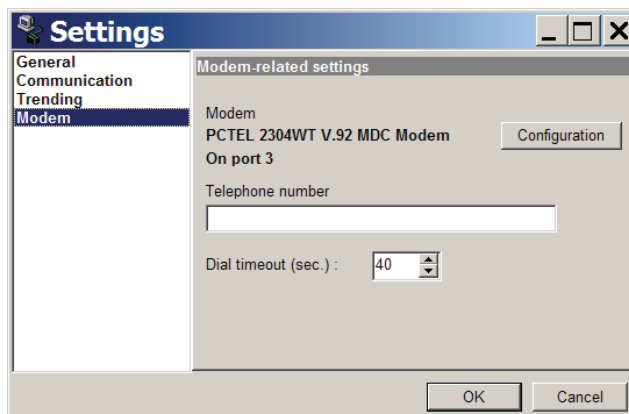

Select modem and key in the telephone number of your GSM modem connected to the unit.

-  In the above example the modem is selected automatically by the PC USW (internal modem in the PC).

When you want to use modem dial-up, the PC USW must also be set to run ASCII communication:

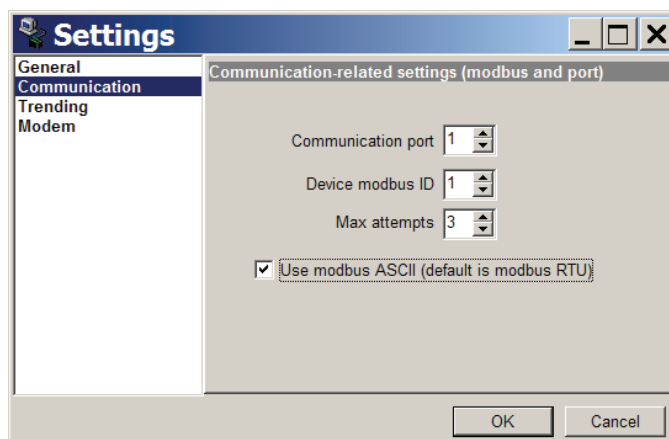

After this, dial-up can be used: Click on the telephone button:

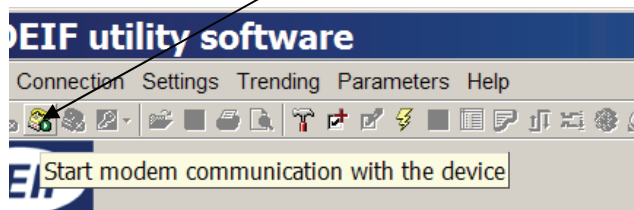

**The modem communication is very much slower than the normal direct connection, so please be patient. It is not recommended to download the entire setting list. Use single setting downloads.**

#### **PC utility software communication safety**

If the communication fails, the controller unit will operate according to the received data. If e.g. only half of the parameter file has been downloaded, when the communication is interrupted, the settings are going to be a mix.

### Auto engine start

The mains fail (GC-1)/  
blackout (GC-1M)  
is an option

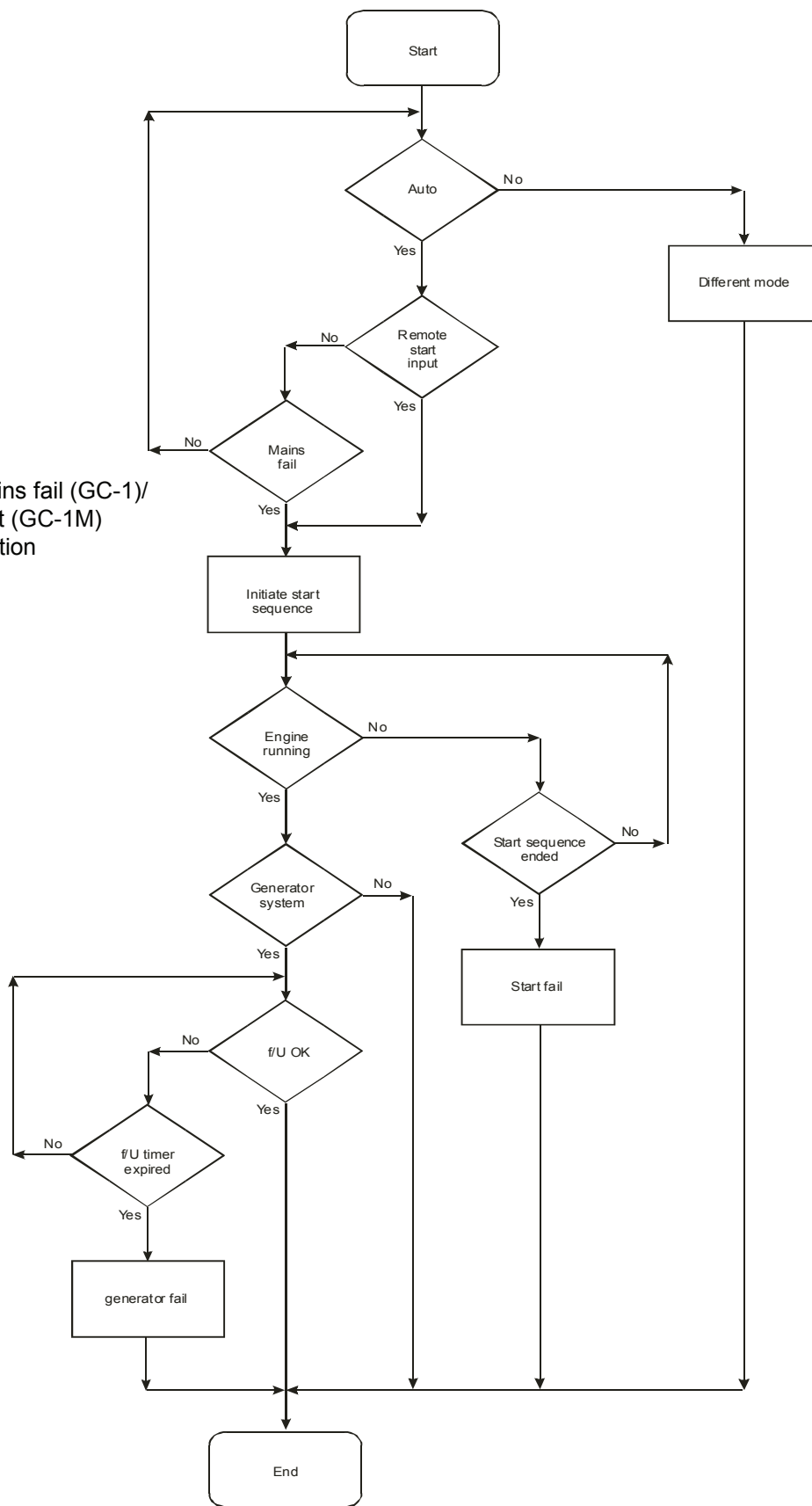

### Start sequences

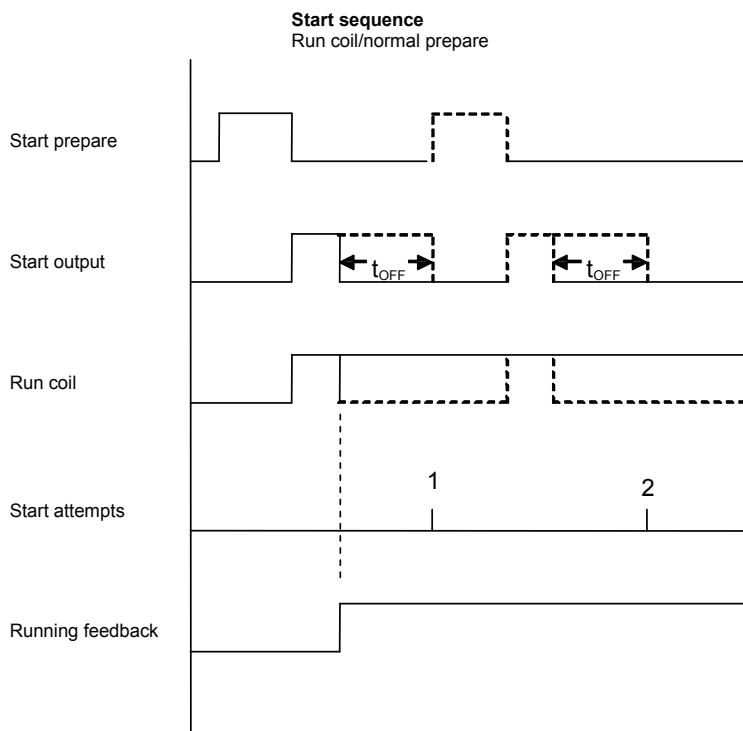
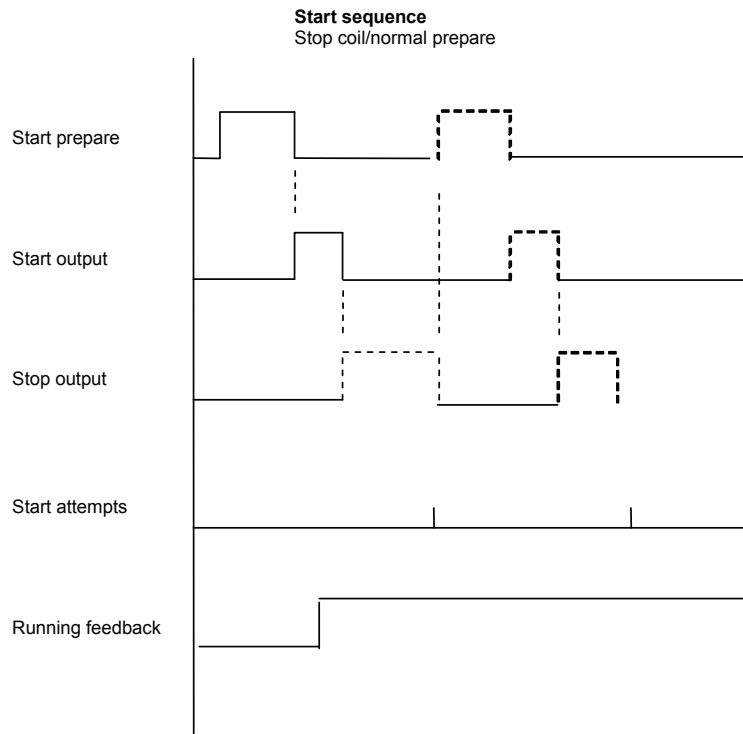



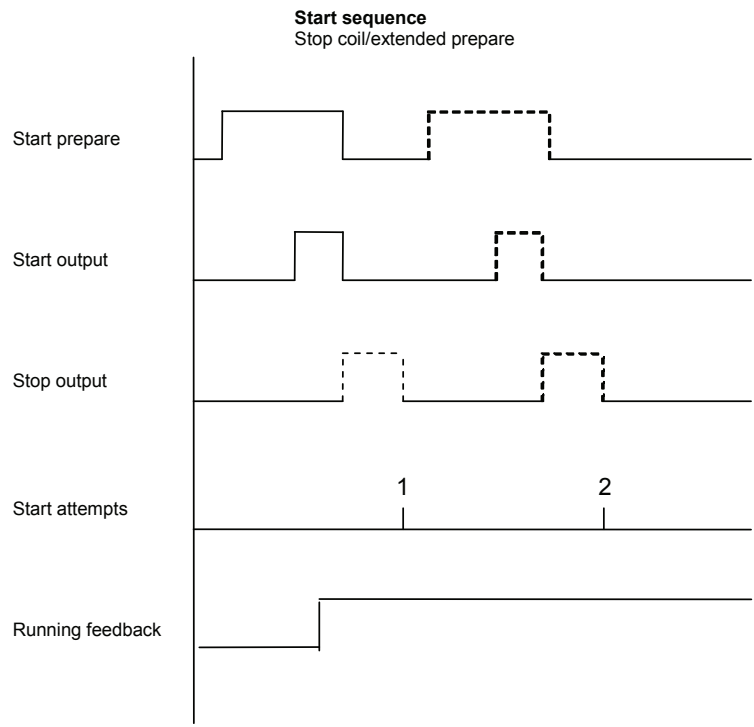
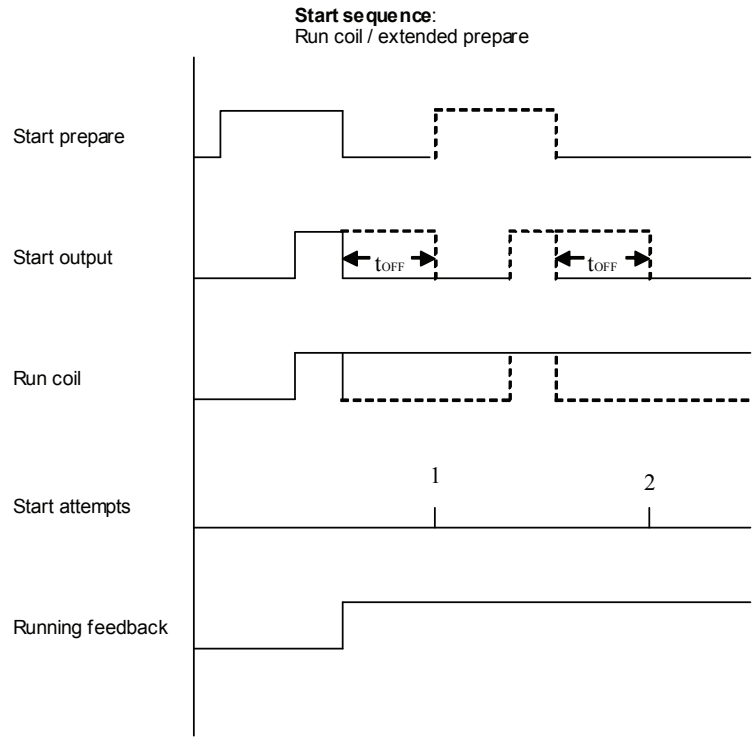

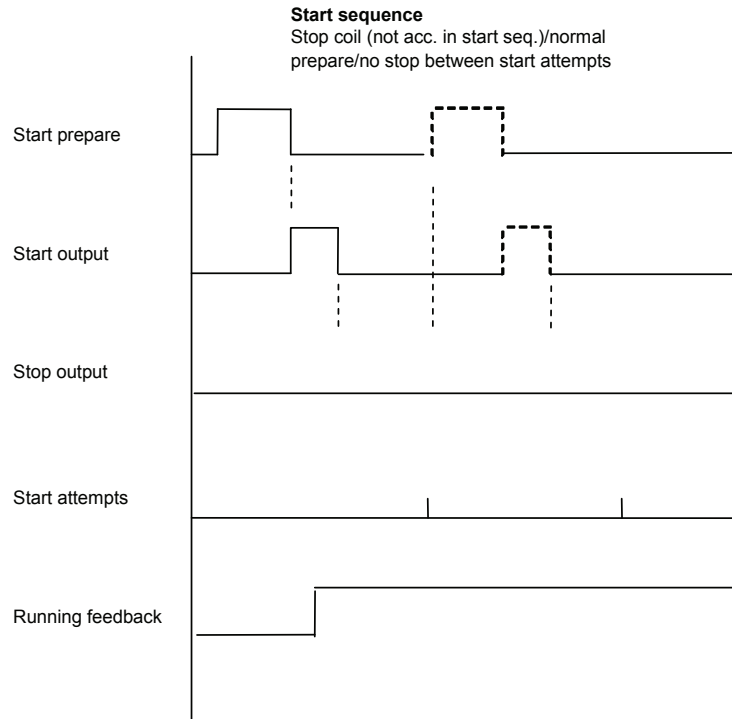

### Interruption of start sequence

The start sequence is interrupted in the following situations:

Event	Comment
Auto mode stop	Removal of start cause (binary input), stop command (pulse) or shutdown.
Start failure	
Running feedback	Tacho setpoint, menu 4341.
Running feedback	Binary input, D+.
Running feedback	Frequency measurement above 30Hz.  The frequency measurement requires a voltage measurement of 30% $U_{NOM}$ . So the running feedback based on the frequency measurement can only be used where the voltage builds up rapidly.
Running feedback	Oil pressure RUN detect menu 4480.
Emergency stop	
Stop push-button on the display	In manual as well as auto operation.

### Start failure alarm

#### 4370 Start attempts

The start failure alarm will occur, if the engine has not started after the last start attempt. A start failure will activate the HORN output and relay outputs if selected.

### Start prepare

#### 4350 Starter

There are two possibilities for use of the start prepare timer:

Normal start prepare	The start prepare relay is activated when the start sequence is initiated for the adjusted time and before each start attempt. It deactivates before cranking.
Extended start prepare	The start prepare relay is activated when the start sequence is initiated, and it stays activated when cranking.

### Idle mode (4360 Idle mode)

Idle mode can be selected in 2 ways:

1. Configurable binary input
2. Timer setting

If a binary input for idle mode is used, activating this will hold the engine in idle mode for as long as the input is activated. This works for both manual and auto mode. Any time the idle mode is activated, the generator breaker will be opened.

If a binary input is not used, a timer function can be set to hold the engine in idle upon start until the timer runs out. This function can be selected to be:

Off (no idling of engine upon start).

Active for:

- both manual and auto: Select Man./aut.
- manual only:               Select Man.
- auto only:                    Select Aut.

In both cases a relay must be selected to Idle in the output list. When idle mode is selected, a delay where the engine is running on low RPM is given. The delay is controlled by the controller, and a relay output will activate the idle control on the engine.

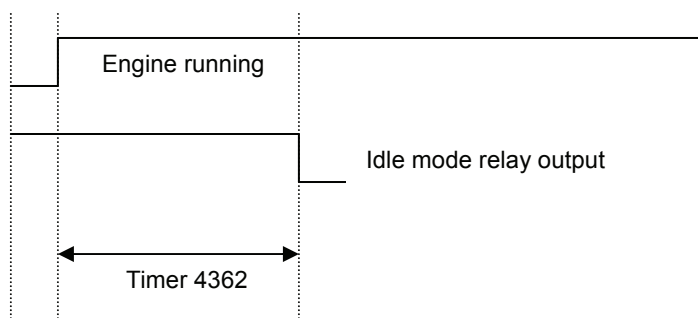

### External heater

The external heater function can be used to turn on an external heat source, when the engine cooling water temperature gets below the limit in parameter 1890. When the engine cooling water temperature reaches the temperature setpoint in parameter 1900, the heater is turned off again.

A relay must be selected in the output list to turn this external heat source on/off. The relay will close to turn the heater on or open to turn it off.

This function will only work, if the engine cooling water temperature sensor is selected to be a VDO sensor.

### Stop sequences

The illustrations indicate the stop sequence schematically.

Stop sequence / RUN coil

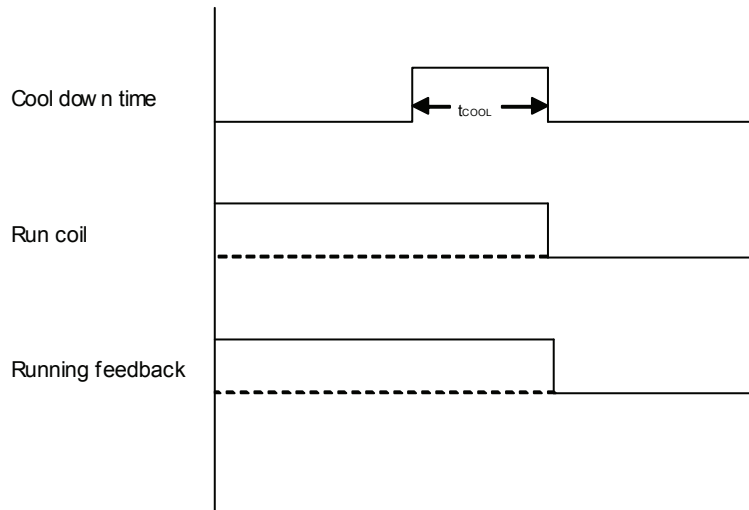

Stop sequence/Stop coil and Stop coil (not acc. in start seq.)

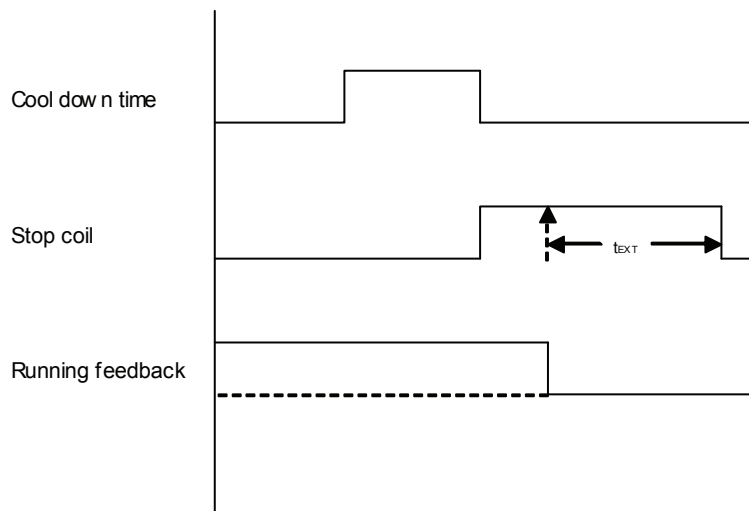

### Stop sequence

The stop sequence will be activated, if a stop command is given. The stop sequence can include the cool down time, if the stop is a normal or controlled stop.

Description	Cool-down	Stop	Comment
Auto mode stop	X	X	
Trip and stop	X	X	Only if option G6 is implemented.
Stop button on display		X	
Binary shutdown input		X	
Emergency stop		X	Engine shutdown and GB opens.

The stop sequence can only be interrupted during the cool down period. Interruptions can occur in these situations:

Event	Comment
Start button is pressed	Manual mode only. Engine will run in idle speed if idle is ON.
Binary start input	Auto mode.
GB close button is pressed	Manual mode only.

### Stop failure alarm

A stop failure alarm will occur, if the running feedback (or the generator voltage and frequency) is still present. The stop failure timer is adjusted in menu 4410. Stop failure will activate the HORN output, and relay outputs if selected. Factory setting is no relay outputs besides horn.

## 7. Parameter list

This chapter includes a complete standard parameter list for setup. Therefore, this chapter is to be used for reference, when information about specific parameters is needed.

### Parameter groups

In the parameter overview, the parameters are divided into three parameter groups. The parameter groups can be enabled and disabled in the parameters 4250-4270. If a parameter group is enabled, the parameters will be accessible from the display of the controller. To see the specific parameter, see in the parameter list. If a parameter is marked (P2), it is available from the display, if parameter group 2 is enabled. The default display parameter setting is the parameter setting that will always be present in the display parameter list. These parameters are marked with a \*.

### Setup

The setup of parameters is performed via the display or the PC utility software (USW). Therefore, the default settings can be changed to the relevant settings through the utility software or by means of the push-buttons on the display.

The settings can be entered through the setup menu. If no entry has taken place before, then the first display to appear is the password display. Enter the factory setting password to gain access to the menus.



**The factory Customer password is 2000. The factory Service password is 2001.**

If no action has been taken after 30 seconds, then the password entry will be deactivated, and a new password entry is needed. (If entry via the USW is used, the password is only needed once per connection).

Each parameter description is structured according to the same principles. Under the parameter title heading, the detailed parameter descriptions are illustrated and presented. First, a table indicating the parameter facts related to the individual parameter title is presented:

Channel number indicated in USW	Parameter title	Changeable settings	Min. – max. set points	Default set point from factory	
<b>1350 VDO input – oil pressure 2.x</b>					
No.	Setting		Min. setting	Max. setting	Factory setting
1350	Oil pressure 2.1	Setpoint	0.0 bar	10.0 bar	4.0 bar
1351	Oil pressure 2.1	Delay	0.0 s	100.0 s	5.0 s
1352	Oil pressure 2.1	Output A	R0 (none)	R3 (relay 3)	R0 (none)
1353	Oil pressure 2.1	Output B	R0 (none)	R3 (relay 3)	R0 (none)
1354	Oil pressure 2.1	Enable	OFF	ON	OFF
1355	Oil pressure 2.1	Fail class	1 Warning	4 Shutdown	2 Trip of GB

The first column indicates the channel number in the USW.

The second column indicates the changeable setting in the PC utility software.

The third and fourth column indicate the minimum/maximum setpoint available for this setting.

The fifth column indicates the default setpoint of the unit from the factory.

When it is necessary, additional information will be supplied after the table in order to make the individual parameter descriptions as informative as possible.



## Parameter overview

### Parameter Group 1

4350 Starter

4400 Run/stop (cool-down)

1390 4-20mA 1.1

1400 4-20mA 1.2

1350 Binary input 2 (oil) terminal 6

1360 Binary input 3 (temp) terminal 7

### Parameter Group 2

1100 Overcurrent 1

1110 Overcurrent 2

1120 Overvoltage

1130 Undervoltage

1140 Overfrequency

1150 Underfrequency

1420 Overspeed 1 (tacho input)

1460 Emergency stop (terminal 8)

1700-1750 Digital input term. 13-18, no cable supervision

1860 Run status

**Error! Reference source not found.****Error! Reference source not found.**

4010 Nominal settings 1

### Parameter Group 3

1390 VDO fuel level input 1.1

1400 VDO fuel level input 1.2

1410 VDO fuel level input 1.3

1440 V-belt failure

1450 Charger gen

1870 D+ input (term. 15)

1880 Fuel pump logic

**Error! Reference source not found.**

4050 Transformer generator

4240 Language

**Error! Reference source not found.****Error! Reference source not found.****Error! Reference source not found.****Error! Reference source not found.**

4340 Tacho config.

4360 Idle mode

### Default display parameter settings

4120 Counter

4220 Battery low voltage

4230 Battery high voltage

4910 Service timer 1

4920 Service timer 2

4380 Hz/V OK

4390 Hz/V failure

4410 Stop failure

4450 GB control

### Parameters only configurable from USW

1090 Reverse power

1340 Configurable input selection

1350 VDO oil press input 2.1

1360 VDO oil press input 2.2

1370 VDO water temp input 3.1

1380 VDO water temp input 3.2

1350 4-20mA 2.1

1360 4-20mA 2.2

1370 4-20mA 3.1

1380 4-20mA 3.2

4460 Alarm horn

**Error! Reference source not found.****Error! Reference source not found.**

4610...4650 Relay functions

4800 Sleep mode

5010 Fuel level config. sensor

5020 Oil pressure config. Sensor

5030 Water temp. config sensor

9000 Password

### Parameter table description

The table consists of the following possible adjustments:

**Setpoint:** The alarm setpoint is adjusted in the setpoint menu. The setting can be in percentage of the nominal values.

**Timer:** The timer setting is the time that must expire from the alarm level is reached until the alarm occurs.

**Relay output A:** A relay can be activated by output A.

**Relay output B:** A relay can be activated by output B.

**Enable:** The alarm can be activated or deactivated. ON means always activated, RUN means that the alarm has run status. This means it is activated when the running signal is present.

**Fail class:** When the alarm occurs, the unit will react depending on the selected fail class.



**Small differences due to the character of the parameters may exist between the individual tables.**

### Fail class

The fail class settings for the protections have the following possibilities:

Value	Comment
0: Warning	Shown in alarm popup window and activates the chosen relays.
1: Trip	Shown in alarm popup window and activates the chosen relays. Trips the breaker.
2: Trip and stop	Shown in alarm popup window and activates the chosen relays. Trips the breaker, cools down the engine and stops it.
3: Shutdown	Shown in alarm popup window and activates the chosen relays. Trips the breaker and shuts the engine down immediately.

### Engine alarm settings (protection)

#### 1090 Reverse power

No.	Setting	Min. setting	Max. setting	Third setting	Factory setting
1091	Reverse power Setpoint	-50.0%	0.0%	-	-5.0%
1092	Reverse power Timer	0.1 s	100.0 s	-	10.0 s
1093	Reverse power Relay output A	R0 (none)	R3 (relay 3)	-	R0 (none)
1094	Reverse power Relay output B	R0 (none)	R3 (relay 3)	-	R0 (none)
1095	Reverse power Enable	OFF	ON	RUN	ON
1096	Reverse power Fail class	Warning	Shutdown	-	Trip

**1100 Overcurrent 1**

No.	Setting		Min. setting	Max. setting	Third setting	Factory setting
1101	Overcurrent 1 (P2)	Setpoint	50.0%	200.0%	-	115.0%
1102	Overcurrent 1 (P2)	Timer	0.1 s	100.0 s	-	10.0 s
1103	Overcurrent 1	Relay output A	R0 (none)	R3 (relay 3)	-	R0 (none)
1104	Overcurrent 1	Relay output B	R0 (none)	R3 (relay 3)	-	R0 (none)
1105	Overcurrent 1	Enable	OFF	ON	RUN	ON
1106	Overcurrent 1	Fail class	Warning	Shutdown	-	Trip

**1110 Overcurrent 2**

No.	Setting		Min. setting	Max. setting	Third setting	Factory setting
1111	Overcurrent 2 (P2)	Setpoint	50.0%	200.0%	-	120.0%
1112	Overcurrent 2 (P2)	Timer	0.1 s	100.0 s	-	5.0 s
1113	Overcurrent 2	Relay output A	R0 (none)	R3 (relay 3)	-	R0 (none)
1114	Overcurrent 2	Relay output B	R0 (none)	R3 (relay 3)	-	R0 (none)
1115	Overcurrent 2	Enable	OFF	ON	RUN	ON
1116	Overcurrent 2	Fail class	Warning	Shutdown	-	Trip

**1120 Overvoltage**

No.	Setting		Min. setting	Max. setting	Third setting	Factory setting
1121	Overvoltage (P2)	Setpoint	80.0%	150.0%	-	115.0%
1122	Overvoltage (P2)	Timer	0.1 s	100.0 s	-	10.0 s
1123	Overvoltage	Relay output A	R0 (none)	R3 (relay 3)	-	R0 (none)
1124	Overvoltage	Relay output B	R0 (none)	R3 (relay 3)	-	R0 (none)
1125	Overvoltage	Enable	OFF	ON	RUN	ON
1126	Overvoltage	Fail class	Warning	Shutdown	-	Warning

**1130 Undervoltage**

No.	Setting		Min. setting	Max. setting	Third setting	Factory setting
1131	Undervoltage (P2)	Setpoint	50.0%	110.0%	-	90.0%
1132	Undervoltage (P2)	Timer	0.1 s	100.0 s	-	5.0 s
1133	Undervoltage	Relay output A	R0 (none)	R3 (relay 3)	-	R0 (none)
1134	Undervoltage	Relay output B	R0 (none)	R3 (relay 3)	-	R0 (none)
1135	Undervoltage	Enable	OFF	ON	RUN	ON
1136	Undervoltage	Fail class	Warning	Shutdown	-	Warning

**1140 Overfrequency**

No.	Setting		Min. setting	Max. setting	Third setting	Factory setting
1141	Overfrequency (P2)	Setpoint	80.0%	150.0%	-	115.0%
1142	Overfrequency (P2)	Timer	0.1 s	100.0 s	-	10.0 s
1143	Overfrequency	Relay output A	R0 (none)	R3 (relay 3)	-	R0 (none)
1144	Overfrequency	Relay output B	R0 (none)	R3 (relay 3)	-	R0 (none)
1145	Overfrequency	Enable	OFF	ON	RUN	ON
1146	Overfrequency	Fail class	Warning	Shutdown	-	Warning

**1150 Underfrequency**

No.	Setting		Min. setting	Max. setting	Third setting	Factory setting
1151	Underfrequency (P2)	Setpoint	50.0%	110.0%	-	90.0%
1152	Underfrequency (P2)	Timer	0.1 s	100.0 s	-	5.0 s
1153	Underfrequency	Relay output A	R0 (none)	R3 (relay 3)	-	R0 (none)
1154	Underfrequency	Relay output B	R0 (none)	R3 (relay 3)	-	R0 (none)
1155	Underfrequency	Enable	OFF	ON	RUN	ON
1156	Underfrequency	Fail class	Warning	Shutdown	-	Warning

**1340 Configurable input selection**

No.	Setting		Min. setting	Max. setting	Factory setting
1341	Conf inp 1	Setpoint	VDO	Binary	VDO
1342	Conf inp 2	Setpoint	VDO	Binary	VDO
1343	Conf inp 3	Setpoint	VDO	Binary	VDO

Possible selections:

- VDO
- 4...20mA
- Binary



It is possible to combine VDO inputs with binary inputs and 4...20mA inputs in a mix.

No.	Setting		Min. setting	Max. setting	Factory setting
1344	Unit	Setpoint	C/bar	F/psi	C/bar



The appearance of settings 1350-1516 is dependent on selection in setting 1340. Only setting for the type selected will appear. This means for the USW that once the setting 1340, 1341, 1342 is carried out and downloaded to the unit, the parameter list must be uploaded again to get the correct functions in the parameter list.

**VDO inputs****1350 VDO oil press input 2.1**

No.	Setting (D)		Min. setting	Max. setting	Factory setting
1351	VDO 2.1	Setpoint	0.0 bar	10.0 bar	4.0 bar
1352	VDO 2.1	Delay	0.0 s	100.0 s	5.0 s
1353	VDO 2.1	Output A	R0 (none)	R5 (relay 5)	R0 (none)
1354	VDO 2.1	Output B	R0 (none)	R5 (relay 5)	R0 (none)
1355	VDO 2.1	Enable	OFF	ON	OFF
1356	VDO 2.1	Fail class	See description of fail classes		

**1360 VDO oil press input 2.2**

No.	Setting (D)		Min. setting	Max. setting	Factory setting
1361	VDO 2.2	Setpoint	0.0 bar	10.0 bar	4.0 bar
1362	VDO 2.2	Delay	0.0 s	100.0 s	5.0 s
1363	VDO 2.2	Output A	R0 (none)	R5 (relay 5)	R0 (none)
1364	VDO 2.2	Output B	R0 (none)	R5 (relay 5)	R0 (none)
1365	VDO 2.2	Enable	OFF	ON	OFF
1366	VDO 2.2	Fail class	See description of fail classes		

<b>1367</b>	VDO	Type	1	3	1
-------------	-----	------	---	---	---

**1370 VDO water temp input 3.1**

No.	Setting		Min. setting	Max. setting	Factory setting
1371	VDO 3.1	Setpoint	0°C	150°C	95°C
1372	VDO 3.1	Delay	0.0 s	100.0 s	5.0 s
1373	VDO 3.1	Output A	R0 (none)	R5 (relay 5)	R0 (none)
1374	VDO 3.1	Output B	R0 (none)	R5 (relay 5)	R0 (none)
1375	VDO 3.1	Enable	OFF	ON	OFF
1376	VDO 3.1	Fail class	See description of fail classes		

**1380 VDO water temp input 3.2**

No.	Setting		Min. setting	Max. setting	Factory setting
1381	VDO 3.2	Setpoint	0°C	150°C	95°C
1382	VDO 3.2	Delay	0.0 s	100.0 s	5.0 s
1383	VDO 3.2	Output A	R0 (none)	R5 (relay 5)	R0 (none)
1384	VDO 3.2	Output B	R0 (none)	R5 (relay 5)	R0 (none)
1385	VDO 3.2	Enable	OFF	ON	OFF
1386	VDO 3.2	Fail class	See description of fail classes		

<b>1387</b>	VDO	Type	1	4	1
-------------	-----	------	---	---	---



**VDO type: See functional description.**

**1390 VDO fuel level input 1.1**

No.	Setting		Min. setting	Max. setting	Factory setting
1391	Fuel level 1.1 (P3)	Setpoint	0%	100%	10%
1392	Fuel level 1.1 (P3)	Delay	0.0 s	100.0 s	5.0 s
1393	Fuel level 1.1	Output A	R0 (none)	R5 (relay 5)	R0 (none)
1394	Fuel level 1.1	Output B	R0 (none)	R5 (relay 5)	R0 (none)
1395	Fuel level 1.1	Enable	OFF	ON	OFF
1396	Fuel level 1.1	Fail class	See description of fail classes		

**1400 VDO fuel level input 1.2**

No.	Setting		Min. setting	Max. setting	Factory setting
1401	Fuel level 1.2 (P3)	Setpoint	0%	100%	99%
1402	Fuel level 1.2 (P3)	Delay	0.0 s	100.0 s	5.0 s
1403	Fuel level 1.2	Output A	R0 (none)	R5 (relay 5)	R0 (none)
1404	Fuel level 1.2	Output B	R0 (none)	R5 (relay 5)	R0 (none)
1405	Fuel level 1.2	Enable	OFF	ON	OFF
1406	Fuel level 1.2	Fail class	See description of fail classes		

**1410 VDO fuel level input 1.3**

No.	Setting		Min. setting	Max. setting	Factory setting
1411	Fuel level 1.3 (P3)	Setpoint	0%	100%	80%
1412	Fuel level 1.3 (P3)	Delay	0.0 s	100.0 s	5.0 s
1413	Fuel level 1.3	Output A	R0 (none)	R5 (relay 5)	R0 (none)
1414	Fuel level 1.3	Output B	R0 (none)	R5 (relay 5)	R0 (none)
1415	Fuel level 1.3	Enable	OFF	ON	OFF
1416	Fuel level 1.3	Fail class	See description of fail classes		

<b>1417</b>	Fuel level 1	Type	1	3	1
-------------	--------------	------	---	---	---

**4-20mA inputs**

The scaling of the 4-20mA inputs for correct display reading can only be done via the USW. Also the selection of HIGH/LOW alarm as well as cable supervision can be carried out in the USW.

**1350 4-20mA 2.1**

No.	Setting		Min. setting	Max. setting	Factory setting
1351	4-20mA 2.1	Setpoint	4mA	20mA	10mA
1352	4-20mA 2.1	Delay	0.0 s	100.0 s	5.0 s
1353	4-20mA 2.1	Output A	R0 (none)	R5 (relay 5)	R0 (none)
1354	4-20mA 2.1	Output B	R0 (none)	R5 (relay 5)	R0 (none)
1355	4-20mA 2.1	Enable	OFF	ON	OFF
1356	4-20mA 2.1	Fail class	See description of fail classes		

**1360 4-20mA 2.2**

No.	Setting		Min. setting	Max. setting	Factory setting
1361	4-20mA 2.2	Setpoint	4mA	20mA	10mA
1362	4-20mA 2.2	Delay	0.0 s	100.0 s	5.0 s
1363	4-20mA 2.2	Output A	R0 (none)	R5 (relay 5)	R0 (none)
1364	4-20mA 2.2	Output B	R0 (none)	R5 (relay 5)	R0 (none)
1365	4-20mA 2.2	Enable	OFF	ON	OFF
1366	4-20mA 2.2	Fail class	See description of fail classes		

**1370 4-20mA 3.1**

No.	Setting		Min. setting	Max. setting	Factory setting
1371	4-20mA 3.1	Setpoint	4mA	20mA	10mA
1372	4-20mA 3.1	Delay	0.0 s	100.0 s	5.0 s
1373	4-20mA 3.1	Output A	R0 (none)	R5 (relay 5)	R0 (none)
1374	4-20mA 3.1	Output B	R0 (none)	R5 (relay 5)	R0 (none)
1375	4-20mA 3.1	Enable	OFF	ON	OFF
1376	4-20mA 3.1	Fail class	See description of fail classes		

**1380 4-20mA 3.2**

No.	Setting		Min. setting	Max. setting	Factory setting
1381	4-20mA 3.2	Setpoint	4mA	20mA	10mA
1382	4-20mA 3.2	Delay	0.0 s	100.0 s	5.0 s
1383	4-20mA 3.2	Output A	R0 (none)	R5 (relay 5)	R0 (none)
1384	4-20mA 3.2	Output B	R0 (none)	R5 (relay 5)	R0 (none)
1385	4-20mA 3.2	Enable	OFF	ON	OFF
1386	4-20mA 3.2	Fail class	See description of fail classes		

**1390 4-20mA 1.1**

No.	Setting		Min. setting	Max. setting	Factory setting
1391	4-20mA 1.1	Setpoint	4mA	20mA	10mA
1392	4-20mA 1.1	Delay	0.0 s	100.0 s	5.0 s
1393	4-20mA 1.1	Output A	R0 (none)	R5 (relay 5)	R0 (none)
1394	4-20mA 1.1	Output B	R0 (none)	R5 (relay 5)	R0 (none)
1395	4-20mA 1.1	Enable	OFF	ON	OFF
1396	4-20mA 1.1	Fail class	See description of fail classes		

**1400 4-20mA 1.2**

No.	Setting		Min. setting	Max. setting	Factory setting
1401	4-20mA 1.2	Setpoint	4mA	20mA	10mA
1402	4-20mA 1.2	Delay	0.0 s	100.0 s	5.0 s
1403	4-20mA 1.2	Output A	R0 (none)	R5 (relay 5)	R0 (none)
1404	4-20mA 1.2	Output B	R0 (none)	R5 (relay 5)	R0 (none)
1405	4-20mA 1.2	Enable	OFF	ON	OFF
1406	4-20mA 1.2	Fail class	See description of fail classes		

**Binary inputs with cable supervision**

The text for the inputs for correct display reading can only be done via the USW.

**1350 Binary input 2 (oil) terminal 6**

No.	Setting		Min. setting	Max. setting	Factory setting
1351	Term. 6	Delay	0.0 s	100.0 s	5.0 s
1352	Term. 6	Output A	R0 (none)	R3 (relay 3)	R0 (none)
1353	Term. 6	Output B	R0 (none)	R3 (relay 3)	R0 (none)
1354	Term. 6	Cable supervision	OFF	ON	OFF
1355	Term. 6	Enable	OFF	ON	OFF
1356	Term. 6	Fail class	See description of fail classes		

**1360 Binary input 3 (temp) terminal 7**

No.	Setting		Min. setting	Max. setting	Factory setting
1361	Term. 7	Delay	0.0 s	100.0 s	5.0 s
1362	Term. 7	Output A	R0 (none)	R3 (relay 3)	R0 (none)
1363	Term. 7	Output B	R0 (none)	R3 (relay 3)	R0 (none)
1364	Term. 7	Cable supervision	OFF	ON	OFF
1365	Term. 7	Enable	OFF	ON	OFF
1366	Term. 7	Fail class	See description of fail classes		

**1370 Binary input 1 (fuel) terminal 5**

No.	Setting		Min. setting	Max. setting	Factory setting
1371	Term. 5	Delay	0.0 s	100.0 s	5.0 s
1372	Term. 5	Output A	R0 (none)	R3 (relay 3)	R0 (none)
1373	Term. 5	Output B	R0 (none)	R3 (relay 3)	R0 (none)
1374	Term. 5	Cable supervision	OFF	ON	OFF
1375	Term. 5	Enable	OFF	ON	OFF
1376	Term. 5	Fail class	See description of fail classes		

**Tacho RPM input****1420 Overspeed 1 (tacho input)**

No.	Setting		Min. setting	Max. setting	Third setting	Factory setting
1421	Overspeed	Setpoint	1 RPM	4000 RPM	-	1900 RPM
1422	Overspeed	Timer	0.2 s	100.0 s	-	15.0 s
1423	Overspeed	Relay output A	R0 (none)	R5 (relay 5)	-	R0 (none)
1424	Overspeed	Relay output B	R0 (none)	R5 (relay 5)	-	R0 (none)
1425	Overspeed	Enable	OFF	ON	RUN	OFF
1426	Overspeed	Fail class	See description of fail classes			



The overspeed setting 1 is disabled, if the secondary set point input is activated.

**1430 Overspeed 2 (tacho input)**

No.	Setting		Min. setting	Max. setting	Third setting	Factory setting
1431	Overspeed	Setpoint	1 RPM	4000 RPM	-	1900 RPM
1432	Overspeed	Timer	0.2 s	100.0 s	-	15.0 s
1433	Overspeed	Relay output A	R0 (none)	R5 (relay 5)	-	R0 (none)
1434	Overspeed	Relay output B	R0 (none)	R5 (relay 5)	-	R0 (none)
1435	Overspeed	Enable	OFF	ON	RUN	OFF
1436	Overspeed	Fail class	See description of fail classes			



The overspeed setting 2 is enabled, if the secondary set point input is activated.

**1440 V-belt failure**

No.	Setting		Min. setting	Max. setting	Factory setting
1441	V-belt (P3)	Timer	0.0 s	10.0 s	1.0 s
1442	V-belt	Relay output A	R0 (none)	R5 (relay 5)	R0 (none)
1443	V-belt	Relay output B	R0 (none)	R5 (relay 5)	R0 (none)
1444	V-belt	Enable	OFF	ON	OFF
1445	V-belt	Fail class	See description of fail classes		



The V-belt failure is used on air-cooled engines to monitor that the V-belt driven cooling fan is operating properly. This alarm requires W input to be used in parallel with another running feedback at the same time. The status of both will be compared. If they do not match, a V-belt alarm will be activated.



**1450 Charger gen**

No.	Setting		Min. setting	Max. setting	Factory setting
1451	Charger gen (P3)	Timer	0.0 s	60.0 s	0.2 s
1452	Charger gen	Relay output A	R0 (none)	R5 (relay 5)	R0 (none)
1453	Charger gen	Relay output B	R0 (none)	R5 (relay 5)	R0 (none)
1454	Charger gen	Enable	OFF	ON	OFF
1455	Charger gen	Fail class	See description of fail classes		



This alarm requires D+ or W input to be used in parallel with another running feedback at the same time (binary input, tacho, generator voltage), the status of both will be compared. If they do not match, a charger gen. alarm will be activated.

**1460 Emergency stop (terminal 8)**

No.	Setting		Min. setting	Max. setting	Factory setting
1461	Emergency STOP	Timer	0.0 s	60.0 s	0.2 s
1462	Emergency STOP	Relay output A	R0 (none)	R5 (relay 5)	R0 (none)
1463	Emergency STOP	Relay output B	R0 (none)	R5 (relay 5)	R0 (none)
1464	Emergency STOP	Enable	OFF	ON	ON
1465	Emergency STOP	Fail class	See description of fail classes		

**1700-1750 Digital input term. 13-18, no cable supervision**

No.	Setting		Min. setting	Max. setting	Third setting	Factory setting
17X1	Dig. input no. XX	Timer	0.0 s	100.0 s	-	10.0 s
17X2	Dig. input no. XX	Relay output A	R0 (none)	R5 (relay 5)	-	R0 (none)
17X3	Dig. input no. XX	Relay output B	R0 (none)	R5 (relay 5)	-	R0 (none)
17X4	Dig. input no. XX	Enable	OFF	ON	RUN	OFF
17X5	Dig. input no. XX	Fail class	See description of fail classes			
17X6	Dig. input no. XX	NO/NC	NO	NC	-	NO

**1860 Run status**

No.	Setting		Min. setting	Max. setting	Factory setting
1861	Run status	Timer	0.0 s	60.0 s	5.0 s
1862	Run status	Relay output A	R0 (none)	R5 (relay 5)	R0 (none)
1863	Run status	Relay output B	R0 (none)	R5 (relay 5)	R0 (none)
1864	Run status	Enable	OFF	ON	OFF

The running status detection has two purposes:

1. When the time delay period expires, all the alarms which have Enable selected to 'RUN' will be activated.
2. An output relay can be selected, if one is available. In that case, the settings Output A and Output B must be set according to the desired relay. To avoid an unwanted display alarm, 'RUN STATUS ALARM', the function of this relay must be selected to 'Limit' function to avoid the alarm when the engine starts. Notice both output A and output B must have the same settings, when the function of the relay is set only as limit switch.

**1870 D+ input (term. 15)**

No.	Setting		Min. setting	Max. setting	Factory setting
1871	D+ input (P3)	Timer	0.0 s	100.0 s	10.0 s
1872	D+ input	Relay output A	R0 (none)	R5 (relay 5)	R0 (none)
1873	D+ input	Enable	OFF	ON	OFF
1874	D+ input	NO/NC	NO	NC	NC



If the D+ input is selected to be ON, this will be used as a running feedback. The D+ output from the charge generator must be connected to input terminal 15 since this is prepared for the purpose, and the terminal 12 (common for terminals 13-18) must be connected to +, otherwise the D+ input does not work.

**1880 Fuel pump logic**

No.	Setting		Min. setting	Max. setting	Factory setting
1881	Fuel pump logic (P3)	Setpoint 1	0%	100%	20%
1882	Fuel pump logic (P3)	Setpoint 2	0%	100%	90%
1883	Fuel pump logic (P3)	Timer	0.1 s	300.0 s	60.0 s
1884	Fuel pump logic	Enable	OFF	ON	OFF



Relay 2 is dedicated to this function and must be set as NOT used in the I/O setting menu.



1341 Conf. inp. 1 must be set to VDO to activate the fuel pump logic.

**1890 External heater on**

No.	Setting		Min. setting	Max. setting	Factory setting
1890	External heater on	Setpoint	0 C/F	100 C/F	10 C/F

**1900 External heater off**

No.	Setting		Min. setting	Max. setting	Factory setting
1900	External heater off	Setpoint	0 C/F	100 C/F	20 C/F



In order to make the external heater function work, a relay must be designated to this function in the output settings.

**4010 Nominal settings 1**

No.	Setting		Min. setting	Max. setting	Factory setting
4011	Nominal settings 1	Frequency	48.0Hz	62.0Hz	60.0Hz
4012	Nominal settings 1	Generator power	4kW	20000kW	480kW
4013	Nominal settings 1	Generator current	0A	9000A	787A
4014	Nominal settings 1	Generator volt.	50V	25000V	440V

**4020 Nominal settings 2**

No.	Setting		Min. setting	Max. setting	Factory setting
4021	Nominal settings 2	Frequency	48.0Hz	62.0Hz	60.0Hz
4022	Nominal settings 2	Generator power	4kW	20000kW	480kW
4023	Nominal settings 2	Generator current	0A	9000A	787A
4024	Nominal settings 2	Generator volt.	50V	25000V	440V

**4030 Nominal settings 3 (1 ph)**

No.	Setting		Min. setting	Max. setting	Factory setting
4031	Nominal settings 3	Frequency	48.0Hz	62.0Hz	60.0Hz
4032	Nominal settings 3	Generator power	4kW	20000kW	480kW
4033	Nominal settings 3	Generator current	0A	9000A	787A
4034	Nominal settings 3	Generator volt.	50V	25000V	440V
4035	Nominal settings 3	Selection	Binary input	ON	Binary input



The voltage set in Nom. setting 1 & 2 is phase to phase values.



If the third set of nominal settings is activated by a binary input, this input must be selected in the input list.

**4050 Transformer generator**

No.	Setting		Min. setting	Max. setting	Factory setting
4051	Transformer gen	Primary	50V	25000V	440V
4052	Transformer gen	Secondary	50V	480V	440V
4053	Transformer gen	Current prim.	5A	9000A	1000A
4054	Transformer gen	Current sec.	1A	5A	5A
4055	Ph-0 readings on/off	Enable	OFF	ON	ON



If no voltage transformer is used, the setting 440/440V can be maintained.



The setting Ph-0 readings on/off enables/disables the display reading of the phase to neutral readings. This can be used in applications with a three-phased generator without a neutral connection.

**4120 Counter**

No.	Setting		Min. setting	Max. setting	Factory setting
4121	Counter*	Running time	0	20000	0
4122	Counter*	No. of GB operations	OFF	ON	OFF
4124	Counter*	Reset counter kWh	OFF	ON	OFF

**4220 Battery low voltage**

No.	Setting		Min. setting	Max. setting	Factory setting
4221	Battery low V*	Setpoint	6.0V	24.0V	16.0V
4222	Battery low V*	Timer	0.0 s	10.0 s	1.0 s
4223	Battery low V	Relay output A	R0 (none)	R5 (relay 5)	R0 (none)
4224	Battery low V	Relay output B	R0 (none)	R5 (relay 5)	R0 (none)
4225	Battery low V	Enable	OFF	ON	ON

**4230 Battery high voltage**

No.	Setting		Min. setting	Max. setting	Factory setting
4231	Battery high V*	Setpoint	15.0V	40.0V	28.0V
4232	Battery high V*	Timer	0.0 s	10.0 s	1.0 s
4233	Battery high V	Relay output A	R0 (none)	R5 (relay 5)	R0 (none)
4234	Battery high V	Relay output B	R0 (none)	R5 (relay 5)	R0 (none)
4235	Battery high V	Enable	OFF	ON	OFF

**4240 Language**

No.	Setting		Setting	Factory setting
4241	Language	English	English	English
		German		
		French		
		Spanish		
		Icon		
		Italian		
		Chinese/Cyrillic		

**4250 Parameter group 1**

No.	Setting		Min. setting	Max. setting	Factory setting
4250	Parameter group 1	Enable	OFF	ON	OFF

**4260 Parameter group 2**

No.	Setting		Min. setting	Max. setting	Factory setting
4260	Parameter group 2	Enable	OFF	ON	OFF

**4270 Parameter group 3**

No.	Setting		Min. setting	Max. setting	Factory setting
4270	Parameter group 3	Enable	OFF	ON	OFF



If a parameter list is enabled, the parameters marked (PX) are available in the display parameter list.

**4320 Diode compensation**

No.	Setting		Min. setting	Max. setting	Factory setting
4320	Diode compensation	Setpoint	0V	1V	0V



The parameter 4320 can add an offset to the supply voltage measurement displayed. This can be useful, if a diode is mounted in the supply connection.

**4340 Tacho config.**

No.	Setting		Min. setting	Max. setting	Factory setting
4341	Tacho config.	Setpoint	0 RPM	4000 RPM	400 RPM
4342	Tacho config.	Number of teeth	0 teeth	500 teeth	0 teeth



The tacho config. set point is used to deactivate the start relay. The number of teeth is used to configure the tacho input. The tacho input must be configured to 0 teeth when not in use. The tacho input accepts magnetic pickup (direct connection) or NPN/PNP/charger generator W input. Refer to functional description for information. Note that the frequency range for the tacho input is 10Hz to 10000Hz.



The \* indicates parameters that can be changed via the push-buttons/display.

**4350 Starter**

No.	Setting		Min. setting	Max. setting	Factory setting
4351	Starter (P1)	Start prepare	0.0 s	600.0 s	5.0 s
4352	Starter (P1)	Start ON time	1.0 s	30.0 s	5.0 s
4353	Starter (P1)	Start OFF time	1.0 s	99.0 s	5.0 s



The settings “start prepare”, “start ON time” and “start OFF time” are the periods in which the start relay is activated.



The start prepare output can e.g. be used for prelubricating or preheating. The start relay output is for activating the engine starter. The start sequence can be activated manually by pressing the “START” push-button in Local (hand) mode.



If no output relay has been chosen as starter relay, the start and stop sequences (cooling down) will be ignored, the GC-1 will only operate as a safety stop device.

**4360 Idle mode**

No.	Setting		Min. setting	Max. setting	Factory setting
4361	Idle mode	Enable	OFF	ON	OFF
4362	Idle mode	Timer	1.0 s	300.0 s	5.0 s
4363	Idle mode	Active	Man.	Man./aut.	Aut.

Idle mode can be controlled via a binary input. If this is selected, the idle mode remains for as long as the input is ON. If a binary input is not used, the idle mode can be selected to be active for manual or auto or both running modes.

- Both manual and auto: Select Man./Aut.
- Manual only: Select Man.
- Auto only: Select Aut.

**4370 Start attempts**

No.	Setting		Min. setting	Max. setting	Factory setting
4370	Start attempts	Attempts	1	10	3
4371	Start attempts	Relay output A	R0 (none)	R5 (relay 5)	R0 (none)
4372	Start attempts	Relay output B	R0 (none)	R5 (relay 5)	R0 (none)

The outputs A and B are activated at a start failure.

**Hz/V monitoring settings****4380 Hz/V OK**

No.	Setting		Min. setting	Max. setting	Factory setting
4381	Hz/V OK*	Timer	1.0 s	99.0 s	5.0 s
4382	Hz/V OK*	Voltage	1%	70%	10%
4383	Hz/V OK*	Frequency	1Hz	20Hz	5Hz



The setting ranges refer to nominal setting (nominal voltage +/- setting %, nominal frequency +/- setting Hz).

**4390 Hz/V failure**

No.	Setting		Min. setting	Max. setting	Factory setting
4391	Hz/V failure*	Timer	1.0 s	99.0 s	30.0 s
4392	Hz/V failure	Relay output A	R0 (none)	R5 (relay 5)	R0 (none)
4393	Hz/V failure	Relay output B	R0 (none)	R5 (relay 5)	R0 (none)
4395	Hz/V failure	Enable	OFF	ON	ON
4396	Hz/V failure	Fail class	See description of fail classes		

When the frequency and voltage have not been OK for the adjusted delay time, an *Hz/V failure* alarm occurs, and output A and B activate.

**4400 Run/stop (cool-down)**

No.	Setting		Min. setting	Max. setting	Factory setting
4401	Run/stop (P1)	Cool down time	0.0 s	999.0 s	240.0 s
4402	Run/stop (P1)	Extended STOP	1.0 s	99.0 s	5.0 s

**4410 Stop failure**

No.	Setting		Min. setting	Max. setting	Factory setting
4411	Stop failure*	Timer	10.0 s	120.0 s	30.0 s
4412	Stop failure	Relay output A	R0 (none)	R5 (relay 5)	R0 (none)
4413	Stop failure	Relay output B	R0 (none)	R5 (relay 5)	R0 (none)

If the engine has not stopped within the delay time, output A and B will activate and a *stop failure* alarm occurs.

**4450 GB control**

No.	Setting		Min. setting	Max. setting	Factory setting
4452	GB sign on delay	Setpoint	0.0 s	10.0 s	1.0 s
4453	GB sign off delay	Setpoint	0.0 s	10.0 s	1.0 s

**4460 Alarm horn**

No.	Setting		Min. setting	Max. setting	Factory setting
4460	Alarm horn*	Timer	0.0 s	990.0 s	20.0 s

According to factory setting the horn output will activate for 20 seconds when an alarm appears. If the timer setting is adjusted to 0, the horn relay will be activated continuously, until the alarm is acknowledged.

**4470 GB on water temp.**

No.	Setting		Min. setting	Max. setting	Factory setting
4471	GB on water temp.	Setpoint	0 C/F	100 C/F	40 C/F
4472	GB on water temp.	Enable	OFF	ON	OFF

**4480 Oil pres. run detection**

No.	Setting		Min. setting	Max. setting	Factory setting
4481	Oil pres. run detection	Setpoint	0 bar/PSI	150 bar/PSI	1 bar/PSI
4482	Oil pres. run detection	Enable	OFF	ON	OFF



**Parameter 4480 Oil pres. run detection makes it possible to use the oil pressure as a running feedback.**

**4610...4650 Relay functions**

No.	Setting		First/min. setting	Second/max. setting	Factory setting
46X1	Relay X	Function	Alarm	Limit	Alarm
46X2	Relay X	Off delay	0.0 s	999.9 s	5.0 s

The relays can be configured in the two different ways described below.

**Alarm relay function:** When an alarm activates the relay, it is activated as long as the alarm is present and unacknowledged. If the Off delay is set different from 0.0 s, a short reset of the relay will take place upon arrival of a new alarm.

**Limit function:** When an input activates the relay, no alarm message is displayed. After the condition activating this relay has returned to normal, the relay will deactivate when the Off delay has expired.

**4790 GSM pin code and dial-up numbers**

No.	Setting		Min. setting	Max. setting	Factory setting
4791	GSM	GSM pin code	0	9999	0
4792	GSM	SMS telephone no.	0	+99999999999999	+4511223344
	GSM	Enable	OFF	ON	OFF
4793	GSM	SMS telephone no.	0	+99999999999999	+4511223344
	GSM	Enable	OFF	ON	OFF
4794	GSM	SMS telephone no.	0	+99999999999999	+4511223344
	GSM	Enable	OFF	ON	OFF
4795	GSM	SMS telephone no.	0	+99999999999999	+4511223344
	GSM	Enable	OFF	ON	OFF
4796	GSM	SMS telephone no.	0	+99999999999999	+4511223344
	GSM	Enable	OFF	ON	OFF



**A telephone number set to 0 means not used.**  
The prefix + and country code must always be entered. E.g. +45 for Denmark.



**If a GSM modem is connected to the programming interface, the communication automatically changes from Modbus RTU to ASCII.**

**4800 Sleep mode**

No.	Setting		Min. setting	Max. setting	Factory setting
4801	Sleep	Timer	0 min.	1800 sec.	600 sec.
4802	Sleep	ON/OFF	OFF	ON	OFF

The sleep mode is a standstill power save mode. If the engine is stopped and nothing has happened within the time setting, the unit will enter sleep mode, i.e. the most power consuming functions (e.g. display) are turned off. As soon as an event occurs (button activated, input state change), the sleep mode is ended.

**4910 Service timer 1**

No.	Setting		Min. setting	Max. setting	Factory setting
4911	Service timer 1	Type	OFF	Run hours	Run hours
4912	Service timer 1*	Setpoint hours	10	10000	150
4913	Service timer 1*	Setpoint days	1	1000	365
4914	Service timer 1	Fail class	See description of fail classes		
4915	Service timer 1	Output A	Relay 0	Relay 5	Relay 0
4916	Service timer 1	Reset	OFF	ON	OFF

**4920 Service timer 2**

No.	Setting		Min. setting	Max. setting	Factory setting
4921	Service timer 2	Type	OFF	Run hours	Run hours
4922	Service timer 2*	Setpoint hours	10	10000	150
4923	Service timer 2*	Setpoint days	1	1000	365
4924	Service timer 2	Fail class	See description of fail classes		
4925	Service timer 2	Output A	Relay 0	Relay 5	Relay 0
4926	Service timer 2	Reset	OFF	ON	OFF

The setting 41 days 16 hours equals 1000 hours.



**9000 Password**

No.	Setting		Min. setting	Max. setting	Factory setting
9001	Password	Customer	0	9999	2000
9002	Password	Service	0	9999	2001

**User password**

If you forget the password, contact DEIF Support for details.

DEIF A/S reserves the right to change any of the above.