



DEEP SEA ELECTRONICS

DSE72/7300 Series Operators Manual

Document Number: 057-074

Author: Anthony Manton



Deep Sea Electronics Plc
 Highfield House
 Hunmanby
 North Yorkshire
 YO14 0PH
 ENGLAND

Sales Tel: +44 (0) 1723 890099
 Sales Fax: +44 (0) 1723 893303

E-mail: sales@deepseapl.com
 Website: www.deepseapl.com

DSE7200 & DSE7300 series Operators Manual

© Deep Sea Electronics Plc

All rights reserved. No part of this publication may be reproduced in any material form (including photocopying or storing in any medium by electronic means or other) without the written permission of the copyright holder except in accordance with the provisions of the Copyright, Designs and Patents Act 1988.

Applications for the copyright holder's written permission to reproduce any part of this publication should be addressed to Deep Sea Electronics Plc at the address above.

The DSE logo and the names are UK registered trademarks of Deep Sea Electronics PLC.

Any reference to trademarked product names used within this publication is owned by their respective companies.

Deep Sea Electronics Plc reserves the right to change the contents of this document without prior notice.

Amendments since last publication

| Amd. No. | Comments |
|----------|--|
| 1 | Added Maintenance Alarm |
| 2 | Added manual fuel pump and manual speed control (Issue 2.1) |
| 3 | Added more detail to many sections of the manual (Issue 2.1) including CTs, Earth Fault, Overcurrent, RS232, Modem, RS485, external sounder, expansion modules (DSE2100 series), |
| 4 | Added changes to Dual Mutual, Fuel usage, dummy load control, load shedding, protections disabled, 2500 series display (for version 4 module additions) |
| 5 | Additions for V5 modules including modem diagnostics and updated front panel editor details including scheduler editing. |
| 6 | Additions for V6 including Mains current alarms and alternative breaker control button operation. |
| 7 | Additions for V7 Electronic Engine features additional alarms. |
| 8 | Additions for V8 new and changed displays added and SMS module control. |
| 9 | Additions for V9 resetting maintenance alarms from facia and cooldown in stop mode. |

Clarification of notation used within this publication.



NOTE:

Highlights an essential element of a procedure to ensure correctness.



CAUTION!

Indicates a procedure or practice, which, if not strictly observed, could result in damage or destruction of equipment.



WARNING!

Indicates a procedure or practice, which could result in injury to personnel or loss of life if not followed correctly.

TABLE OF CONTENTS

| Section | Page |
|--|-----------|
| DEEP SEA ELECTRONICS | 1 |
| 1 BIBLIOGRAPHY | 6 |
| 1.1 INSTALLATION INSTRUCTIONS | 6 |
| 1.2 TRAINING GUIDES | 6 |
| 1.3 MANUALS..... | 6 |
| 1.4 THIRD PARTY DOCUMENTS..... | 6 |
| 2 INTRODUCTION | 7 |
| 3 SPECIFICATIONS | 8 |
| 3.1 PART NUMBERING | 8 |
| 3.2 MODEL NAMING..... | 8 |
| 3.3 SHORT NAMES..... | 9 |
| 3.4 TERMINAL SPECIFICATION | 9 |
| 3.5 POWER SUPPLY REQUIREMENTS | 9 |
| 3.5.1 PLANT SUPPLY INSTRUMENTATION DISPLAY | 9 |
| 3.6 GENERATOR AND MAINS VOLTAGE / FREQUENCY SENSING | 10 |
| 3.7 CURRENT SENSING..... | 10 |
| 3.8 INPUTS | 10 |
| 3.8.1 DIGITAL INPUTS | 10 |
| 3.8.2 ANALOGUE INPUTS..... | 11 |
| 3.8.2.1 OIL PRESSURE..... | 11 |
| 3.8.2.2 COOLANT TEMPERATURE | 11 |
| 3.8.2.3 FUEL LEVEL..... | 12 |
| 3.8.2.4 FLEXIBLE SENSOR..... | 12 |
| 3.8.3 CHARGE FAIL INPUT | 12 |
| 3.8.4 MAGNETIC PICKUP | 13 |
| 3.9 OUTPUTS | 13 |
| 3.9.1 OUTPUTS A & B..... | 13 |
| 3.9.2 OUTPUTS C & D | 13 |
| 3.9.3 OUTPUTS E,F,G & H | 13 |
| 3.10 COMMUNICATION PORTS..... | 14 |
| 3.11 COMMUNICATION PORT USAGE | 14 |
| 3.11.1 CAN INTERFACE | 14 |
| 3.11.2 USB CONNECTION | 15 |
| 3.11.3 RS232 | 16 |
| 3.11.4 RS485 | 18 |
| 3.12 DSENET® FOR EXPANSION MODULES..... | 19 |
| 3.12.1 DSENET® USED FOR MODBUS ENGINE CONNECTION | 19 |
| 3.13 SOUNDER..... | 20 |
| 3.13.1 ADDING AN EXTERNAL SOUNDER TO THE APPLICATION | 20 |
| 3.14 ACCUMULATED INSTRUMENTATION | 20 |
| 3.15 DIMENSIONS AND MOUNTING | 21 |
| 3.15.1 FIXING CLIPS..... | 22 |
| 3.15.2 CABLE TIE FIXING POINTS | 23 |
| 3.15.3 SILICON SEALING GASKET..... | 23 |
| 3.16 APPLICABLE STANDARDS..... | 24 |
| 3.16.1 ENCLOSURE CLASSIFICATIONS..... | 26 |
| 3.16.2 NEMA CLASSIFICATIONS..... | 27 |
| 4 INSTALLATION | 28 |
| 4.1 USER CONNECTIONS..... | 28 |
| 4.2 TERMINAL DESCRIPTION | 29 |
| 4.2.1 DC SUPPLY, FUEL AND START OUTPUTS..... | 29 |
| 4.2.2 ANALOGUE SENSORS..... | 30 |
| 4.2.3 MAGNETIC PICKUP, CAN AND EXPANSION | 31 |

| | | |
|------------|--|-----------|
| 4.2.4 | LOAD SWITCHING AND GENERATOR VOLTAGE SENSING | 32 |
| 4.2.5 | MAINS VOLTAGE SENSING | 32 |
| 4.2.6 | GENERATOR CURRENT TRANSFORMERS..... | 33 |
| 4.2.7 | CONFIGURABLE DIGITAL INPUTS..... | 35 |
| 4.2.8 | PC CONFIGURATION INTERFACE CONNECTOR | 35 |
| 4.2.9 | RS485 CONNECTOR | 36 |
| 4.2.10 | RS232 CONNECTOR | 36 |
| 4.3 | TYPICAL WIRING DIAGRAMS | 37 |
| 4.3.1 | 7210 AUTOSTART CONTROLLER..... | 38 |
| 4.3.2 | 7220 AMF CONTROLLER | 39 |
| 4.3.3 | 7310 AUTOSTART CONTROLLER..... | 40 |
| 4.3.4 | 7320 AMF CONTROLLER | 41 |
| 4.3.5 | DSENET® | 42 |
| 4.3.6 | CONNECTIONS FOR DUAL MUTUAL STANDBY..... | 43 |
| 4.3.7 | EARTH SYSTEMS | 44 |
| 4.3.7.1 | NEGATIVE EARTH..... | 44 |
| 4.3.7.2 | POSITIVE EARTH..... | 44 |
| 4.3.7.3 | FLOATING EARTH..... | 44 |
| 4.4 | ALTERNATIVE TOPOLOGIES..... | 45 |
| 4.4.1 | 3 PHASE, 4 WIRE WITHOUT EARTH FAULT PROTECTION | 45 |
| 4.4.2 | SINGLE PHASE WITH RESTRICTED EARTH FAULT | 46 |
| 4.4.3 | SINGLE PHASE WITHOUT EARTH FAULT | 47 |
| 4.4.4 | 2 PHASE (L1 & L2) 3 WIRE WITH RESTRICTED EARTH FAULT..... | 48 |
| 4.4.5 | 2 PHASE (L1 & L2) 3 WIRE WITHOUT EARTH FAULT | 49 |
| 4.4.6 | 2 PHASE (L1 & L3) 3 WIRE WITH RESTRICTED EARTH FAULT..... | 50 |
| 4.4.7 | 2 PHASE (L1 & L3) 3 WIRE WITHOUT EARTH FAULT MEASURING | 51 |
| 4.4.8 | 3 PHASE 4 WIRE WITH UNRESTRICTED EARTH FAULT MEASURING | 52 |
| 4.4.9 | CT LOCATION | 53 |
| 4.5 | TYPICAL ARRANGEMENT OF DSENET®..... | 54 |
| 5 | DESCRIPTION OF CONTROLS..... | 55 |
| 5.1 | DSE7210 / DSE7310 AUTOSTART CONTROL MODULE | 55 |
| 5.2 | DSE7220 / DSE7320 AMF CONTROL MODULE..... | 57 |
| 5.3 | QUICKSTART GUIDE..... | 59 |
| 5.3.1 | STARTING THE ENGINE | 59 |
| 5.3.2 | STOPPING THE ENGINE..... | 59 |
| 5.4 | VIEWING THE INSTRUMENT PAGES..... | 60 |
| 5.4.1 | STATUS | 61 |
| 5.4.2 | ENGINE..... | 62 |
| 5.4.3 | GENERATOR..... | 63 |
| 5.4.4 | MAINS (DSE7220/DSE7320 ONLY) | 64 |
| 5.4.5 | SERIAL PORT..... | 64 |
| 5.4.6 | ABOUT | 68 |
| 5.4.7 | CAN ERROR MESSAGES..... | 69 |
| 5.5 | VIEWING THE EVENT LOG | 70 |
| 5.6 | USER CONFIGURABLE INDICATORS | 71 |
| 5.7 | CONTROLS | 72 |
| 5.7.1.1 | TEST (DSE7220/DSE7320 ONLY) | 72 |
| 5.7.1.2 | START..... | 72 |
| 6 | OPERATION (STANDALONE)..... | 74 |
| 6.1 | ALTERNATIVE CONFIGURATIONS..... | 74 |
| 6.2 | DUMMY LOAD / LOAD SHEDDING CONTROL..... | 75 |
| 6.2.1 | DUMMY LOAD CONTROL | 75 |
| 6.2.2 | LOAD SHEDDING CONTROL..... | 76 |
| 6.3 | SMS CONTROL | 77 |
| 6.4 | STOP MODE | 78 |
| 6.4.1 | ECU OVERRIDE | 79 |
| 6.5 | AUTOMATIC MODE | 80 |
| 6.5.1 | WAITING IN AUTO MODE | 80 |
| 6.5.2 | STARTING SEQUENCE | 80 |
| 6.5.3 | ENGINE RUNNING..... | 81 |
| 6.5.4 | STOPPING SEQUENCE..... | 81 |
| 6.6 | MANUAL MODE | 82 |

| | | |
|-------------|--|------------|
| 6.6.1 | WAITING IN MANUAL MODE | 82 |
| 6.6.2 | STARTING SEQUENCE..... | 82 |
| 6.6.3 | ENGINE RUNNING..... | 83 |
| 6.6.4 | MANUAL FUEL PUMP CONTROL..... | 83 |
| 6.6.5 | MANUAL SPEED CONTROL | 83 |
| 6.6.6 | STOPPING SEQUENCE | 84 |
| 6.7 | TEST MODE | 85 |
| 6.7.1 | WAITING IN TEST MODE..... | 85 |
| 6.7.2 | STARTING SEQUENCE..... | 85 |
| 6.7.3 | ENGINE RUNNING..... | 86 |
| 7 | OPERATION (DUAL MUTUAL STANDBY) | 87 |
| 8 | PROTECTIONS..... | 88 |
| 8.1 | PROTECTIONS DISABLED..... | 89 |
| 8.1.1 | INDICATION / WARNING ALARMS..... | 89 |
| 8.1.2 | SHUTDOWN / ELECTRICAL TRIP ALARMS | 89 |
| 8.1.3 | CAN ALARMS..... | 90 |
| 8.2 | INDICATIONS | 91 |
| 8.3 | WARNINGS..... | 92 |
| 8.4 | HIGH CURRENT WARNING ALARM | 93 |
| 8.5 | SHUTDOWNS..... | 94 |
| 8.6 | ELECTRICAL TRIPS..... | 96 |
| 8.7 | HIGH CURRENT SHUTDOWN / ELECTRICAL TRIP ALARM | 97 |
| 8.7.1 | IMMEDIATE WARNING..... | 97 |
| 8.7.2 | IDMT ALARM..... | 97 |
| 8.8 | EARTH FAULT SHUTDOWN / ELECTRICAL TRIP ALARM | 100 |
| 8.9 | SHORT CIRCUIT ALARM | 101 |
| 8.10 | MAINTENANCE ALARM | 102 |
| 8.11 | SCHEDULER | 103 |
| 8.11.1 | STOP MODE..... | 103 |
| 8.11.2 | MANUAL MODE | 103 |
| 8.11.3 | AUTO MODE | 103 |
| 8.12 | FRONT PANEL CONFIGURATION..... | 104 |
| 8.13 | ACCESSING THE MAIN FRONT PANEL CONFIGURATION EDITOR | 105 |
| 8.13.1 | EDITING A PARAMETER..... | 106 |
| 8.13.2 | ADJUSTABLE PARAMETERS | 107 |
| 8.14 | ACCESSING THE 'RUNNING' CONFIGURATION EDITOR | 109 |
| 8.14.1 | EDITING A PARAMETER..... | 109 |
| 8.14.2 | ADJUSTABLE PARAMETERS (RUNNING EDITOR) | 109 |
| 9 | COMMISSIONING..... | 110 |
| 9.1.1 | PRE-COMMISSIONING..... | 110 |
| 10 | FAULT FINDING | 111 |
| 11 | MAINTENANCE, SPARES, REPAIR AND SERVICING | 113 |
| 11.1 | PURCHASING ADDITIONAL CONNECTOR PLUGS FROM DSE..... | 113 |
| 11.1.1 | DSE7200 SERIES..... | 113 |
| 11.1.1.1 | PACK OF PLUGS..... | 113 |
| 11.1.1.2 | INDIVIDUAL PLUGS..... | 113 |
| 11.1.2 | DSE7300 SERIES..... | 114 |
| 11.1.2.1 | PACK OF PLUGS..... | 114 |
| 11.1.2.2 | INDIVIDUAL PLUGS..... | 114 |
| 11.2 | PURCHASING ADDITIONAL FIXING CLIPS FROM DSE..... | 114 |
| 11.3 | PURCHASING ADDITIONAL SEALING GASKET FROM DSE..... | 114 |
| 11.4 | EXPANSION MODULES..... | 115 |
| 11.5 | ETHERNET (LAN) CONNECTION | 116 |
| 12 | WARRANTY | 117 |
| 13 | DISPOSAL..... | 117 |
| 13.1 | WEEE (WASTE ELECTRICAL AND ELECTRONIC EQUIPMENT) | 117 |
| 13.2 | ROHS (RESTRICTION OF HAZARDOUS SUBSTANCES)..... | 117 |

1 BIBLIOGRAPHY

This document refers to and is referred to by the following DSE publications which can be obtained from the DSE website www.deepseapl.com

1.1 INSTALLATION INSTRUCTIONS

Installation instructions are supplied with the product in the box and are intended as a 'quick start' guide only.

| DSE PART | DESCRIPTION |
|----------|---|
| 053-026 | DSE7210 Installation Instructions |
| 053-027 | DSE7220 Installation Instructions |
| 053-028 | DSE7310 Installation Instructions |
| 053-029 | DSE7320 Installation Instructions |
| 053-032 | DSE2548 LED Expansion Annunciator Installation Instructions |
| 053-033 | DSE2130 Input Expansion Installation Instructions |
| 053-034 | DSE2157 Output Expansion Installation Instructions |
| 053-064 | DSE2500 Series Display Expansion Installation Instructions |

1.2 TRAINING GUIDES

Training Guides are produced to give 'handout' sheets on specific subjects during training sessions

| DSE PART | DESCRIPTION |
|----------|-----------------------------|
| 056-005 | Using CTs With DSE Products |
| 056-010 | Overcurrent Protection |
| 056-018 | Negative Phase Sequence |
| 056-019 | Earth Fault Protection |
| 056-020 | Loss of Excitation |
| 056-022 | Breaker Control |
| 056-024 | GSM Modem |
| 056-026 | kW & kVAr |
| 056-029 | Smoke Limiting |
| 056-030 | Module PIN Codes |

1.3 MANUALS

| DSE PART | DESCRIPTION |
|----------|--|
| 057-004 | Electronic Engines And DSE Wiring Manual |
| 057-077 | DSE7000 Series Configuration Software Manual |
| 057-082 | DSE2130 Input Expansion Manual |
| 057-083 | DSE2157 Output Expansion Manual |
| 057-084 | DSE2548 Annunciator Expansion Manual |
| 057-107 | DSE2500 Series Display Operator Manual |

1.4 THIRD PARTY DOCUMENTS

The following third party documents are also referred to:

| REFERENCE | DESCRIPTION |
|--------------------|---|
| ISBN 1-55937-879-4 | IEEE Std C37.2-1996 IEEE Standard Electrical Power System Device Function Numbers and Contact Designations. Institute of Electrical and Electronics Engineers Inc |
| ISBN 0-7506-1147-2 | Diesel generator handbook. L.L.J.Mahon |
| ISBN 0-9625949-3-8 | On-Site Power Generation. EGSA Education Committee. |

2 INTRODUCTION

This document does not contain operating instructions for the DSE7500 series synchronising and load sharing controllers. This is contained within DSE publications - part numbers 057-088 (DSE7510), 057-089 (DSE7520) and 057-090 (DSE7560).

This document details the installation and operation requirements of the DSE7200 and DSE7300 Series modules, part of the DSEControl® range of products. The manual forms part of the product and should be kept for the entire life of the product. If the product is passed or supplied to another party, ensure that this document is passed to them for reference purposes. This is not a *controlled document*. You will not be automatically informed of updates. Any future updates of this document will be included on the DSE website at www.deepseapl.com

The **DSE7000 series** is designed to provide differing levels of functionality across a common platform. This allows the generator OEM greater flexibility in the choice of controller to use for a specific application.

The **DSE7000 series** module has been designed to allow the operator to start and stop the generator, and if required, transfer the load to the generator either manually (via fascia mounted push-buttons) or automatically. Additionally, the DSE7320 automatically starts and stops the generator set depending upon the status of the mains (utility) supply.

The user also has the facility to view the system operating parameters via the LCD display.

The **DSE7000** module monitors the engine, indicating the operational status and fault conditions, automatically shutting down the engine and giving a true first up fault condition of an engine failure by a COMMON AUDIBLE ALARM. The LCD display indicates the fault.

The powerful ARM microprocessor contained within the module allows for incorporation of a range of complex features:

- *Text based LCD display (supporting multiple languages).*
- **True RMS Voltage, Current and Power monitoring.**
- *Engine parameter monitoring.*
- *Fully configurable inputs for use as alarms or a range of different functions.*
- *Engine ECU interface to **electronic engines**.*

Using a PC and the Configuration Suite software allows alteration of selected operational sequences, timers and alarms.

Additionally, the module's integral fascia configuration editor allows adjustment of a subset of this information. A robust plastic case designed for front panel mounting houses the module. Connections are via locking plug and sockets.

3 SPECIFICATIONS

3.1 PART NUMBERING

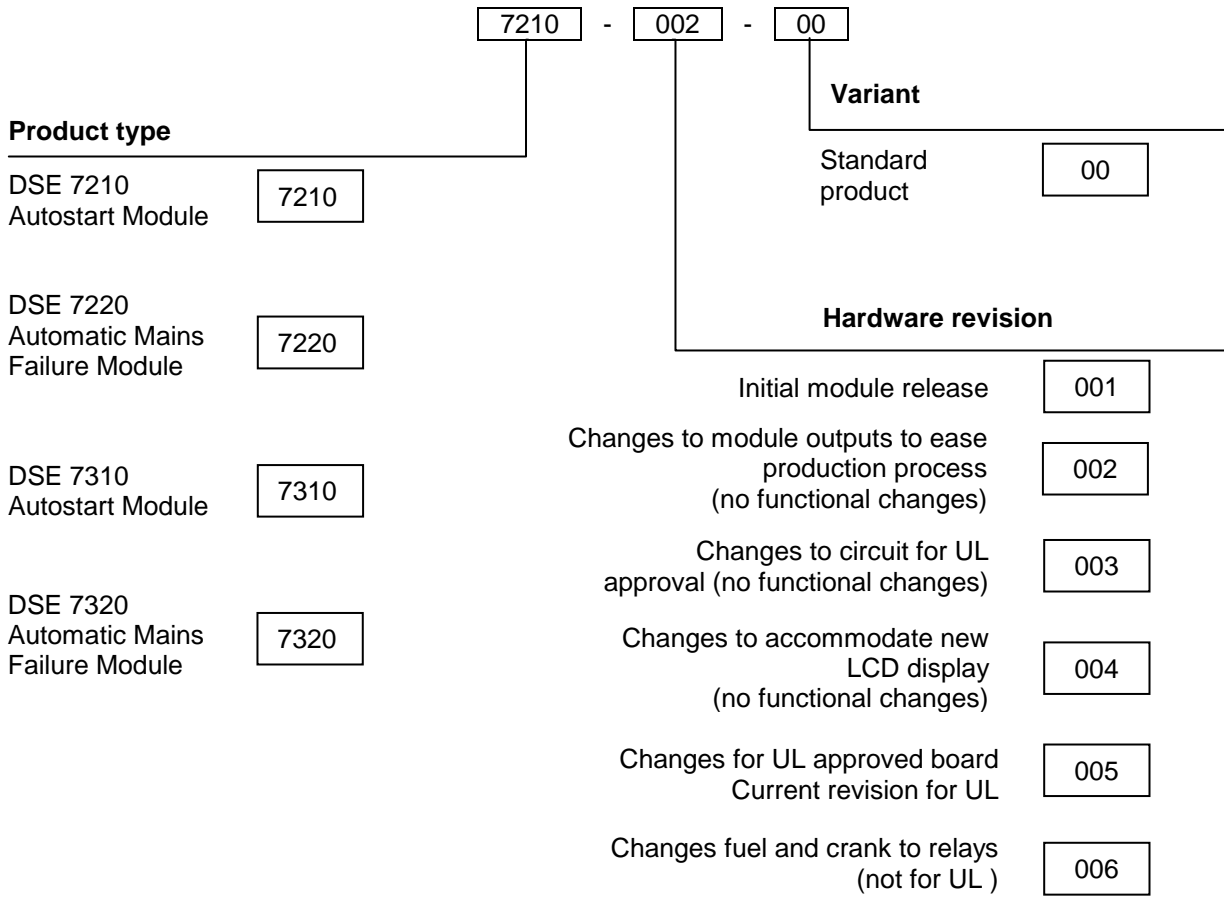

At the time of this document production, there are no variants of this product.

This document does not contain operating instructions for the DSE7500 series synchronising and load sharing controllers. This is contained within DSE publications - part numbers 057-088 (DSE7510), 057-089 (DSE7520) and 057-090 (DSE7560).

3.2 MODEL NAMING

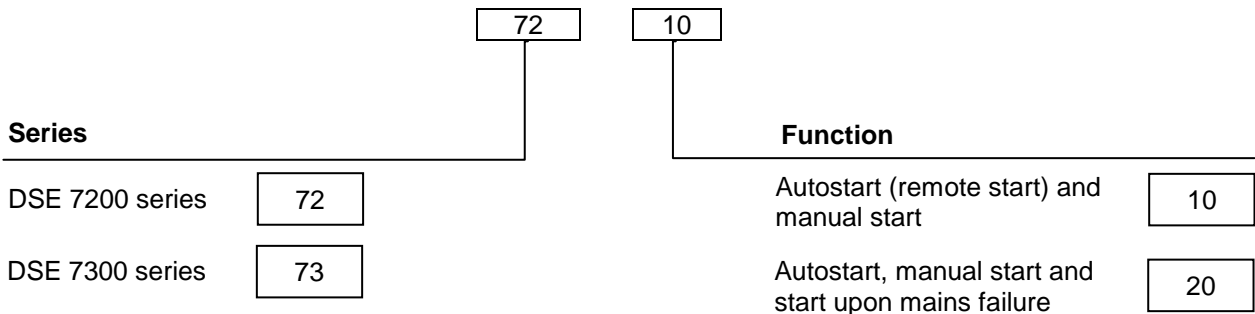

3.6 GENERATOR AND MAINS VOLTAGE / FREQUENCY SENSING

| | |
|-------------------------------|---|
| Measurement type | True RMS conversion |
| Sample Rate | 5KHz or better |
| Harmonics | Up to 10 th or better |
| Input Impedance | 300K Ω ph-N |
| Phase to Neutral | 15V (minimum required for sensing frequency) to 333V AC (absolute maximum) Suitable for 110V to 277V nominal ($\pm 20\%$ for under/overvoltage detection) |
| Phase to Phase | 26V (minimum required for sensing frequency) to 576V AC (absolute maximum) Suitable for 190V ph-ph to 479V ph-ph nominal ($\pm 20\%$ for under/overvoltage detection) |
| Common mode offset from Earth | 100V AC (max) |
| Resolution | 1V AC phase to neutral 2V AC phase to phase |
| Accuracy | $\pm 1\%$ of full scale phase to neutral ($\pm 3.33V$ ph-N) $\pm 2\%$ of full scale phase to phase ($\pm 11.52V$ ph-ph) |
| Minimum frequency | 3.5Hz |
| Maximum frequency | 75.0Hz |
| Frequency resolution | 0.1Hz |
| Frequency accuracy | $\pm 0.2Hz$ |

3.7 CURRENT SENSING

| | |
|-----------------------------|--|
| Measurement type | True RMS conversion |
| Sample Rate | 5KHz or better |
| Harmonics | Up to 10 th or better |
| Nominal CT secondary rating | 1A or 5A (5A recommended) |
| Maximum continuous current | 5A |
| Overload Measurement | 3 x Nominal Range setting |
| Absolute maximum overload | 50A for 1 second |
| Burden | 0.5VA (0.02 Ω current shunts) |
| common mode offset | $\pm 2V$ peak plant ground to CT common terminal |
| Resolution | 0.5% of 5A |
| Accuracy | $\pm 1\%$ of Nominal (1A or 5A) (excluding CT error) |

3.8 INPUTS

3.8.1 DIGITAL INPUTS

| | | |
|-------------------------|---|---|
| Number | DSE7200 | 6 |
| | DSE7300 | 8 |
| Arrangement | Contact between terminal and ground | |
| Low level threshold | 2.1V minimum | |
| High level threshold | 6.6V maximum | |
| Maximum input voltage | +50V DC with respect to plant supply negative | |
| Minimum input voltage | -24V DC with respect to plant supply negative | |
| Contact wetting current | 7mA typical | |
| Open circuit voltage | 12V typical | |

3.8.2 ANALOGUE INPUTS

3.8.2.1 OIL PRESSURE

| | |
|-------------------------|--|
| Measurement type | Resistance measurement by measuring voltage across sensor with a fixed current applied |
| Arrangement | Differential resistance measurement input |
| Measurement current | 15mA |
| Full scale | 240Ω |
| Over range / fail | 270Ω |
| Resolution | 1-2 PSI / 0.1 Bar |
| Accuracy | ±2% of full scale resistance (±4.8Ω) excluding transducer error |
| Max common mode voltage | ±2V |
| Display range | 0-200 PSI / 13.7 bar subject to limits of the sensor |

3.8.2.2 COOLANT TEMPERATURE

| | |
|-------------------------|--|
| Measurement type | Resistance measurement by measuring voltage across sensor with a fixed current applied |
| Arrangement | Differential resistance measurement input |
| Measurement current | 10mA |
| Full scale | 480Ω |
| Over range / fail | 540Ω |
| Resolution | 1°C, 2°F |
| Accuracy | +/-2% of full scale resistance (±9.6Ω) excluding transducer error |
| Max common mode voltage | ±2V |
| Display range | 0°C -140°C, 32°F - 284°F Depending on sensor |

3.8.2.3 FUEL LEVEL

| | |
|-------------------------|--|
| Measurement type | Resistance measurement by measuring voltage across sensor with a fixed current applied |
| Arrangement | Differential resistance measurement input |
| Measurement current | 10mA |
| Full scale | 480Ω |
| Over range / fail | 540Ω |
| Resolution | 1% |
| Accuracy | +/-2% of full scale resistance ($\pm 9.6\Omega$) excluding transducer error |
| Max common mode voltage | $\pm 2V$ |
| Display range | 0-250% |

3.8.2.4 FLEXIBLE SENSOR

 **NOTE : Flexible sensor is not available on DSE7200 series controllers**

| | |
|-------------------------|--|
| Measurement type | Resistance measurement by measuring voltage across sensor with a fixed current applied |
| Arrangement | Differential resistance measurement input |
| Measurement current | 10mA |
| Full scale | 480Ω |
| Over range / fail | 540Ω |
| Resolution | 1% |
| Accuracy | +/-2% of full scale resistance ($\pm 9.6\Omega$) excluding transducer error |
| Max common mode voltage | $\pm 2V$ |
| Display range | 0-250% |

3.8.3 CHARGE FAIL INPUT

| | |
|-----------------|---|
| Minimum voltage | 0V |
| Maximum voltage | 35V (plant supply) |
| Resolution | 0.2V |
| Accuracy | $\pm 1\%$ of max measured voltage ($\pm 0.35V$) |
| Excitation | Active circuit constant power output |
| Output Power | 2.5W Nominal @12V and 24V |
| Current at 12V | 210mA |
| Current at 24V | 104mA |

3.8.4 MAGNETIC PICKUP

| | |
|-------------------------|---|
| Type | Differential input |
| Minimum voltage | 0.5V RMS |
| Max common mode voltage | ±2V |
| Maximum voltage | Clamped to ±70V by transient suppressers, dissipation not to exceed 1W. |
| Maximum frequency | 10,000Hz |
| Resolution | 6.25 RPM |
| Accuracy | ±25 RPM |
| Flywheel teeth | 10 to 500 |

NOTE : DSE can supply a suitable magnetic pickup device, available in two body thread lengths :
DSE Part number 020-012 - Magnetic Pickup probe 5/8 UNF 2½" thread length
DSE Part number 020-013 - Magnetic Pickup probe 5/8 UNF 4" thread length

Magnetic Pickup devices can often be 'shared' between two or more devices. For example, one device can often supply the signal to both the DSE7000 series module and the engine governor. The possibility of this depends upon the amount of current that the magnetic pickup can supply.

3.9 OUTPUTS

3.9.1 OUTPUTS A & B

| | |
|--------|---|
| Type | Normally used for Fuel / Start outputs. Fully configurable for other purposes if the module is configured to control an electronic engine. Supplied from Emergency Stop terminal 3. |
| Rating | 15A resistive @ 35V |

3.9.2 OUTPUTS C & D

| | |
|--------|---|
| Type | Voltage free relays, fully configurable, normally used for generator / mains load switch control. |
| Rating | 8A resistive @ 250 V AC |

3.9.3 OUTPUTS E,F,G & H

| | |
|--------|---|
| Type | Fully configurable, supplied from DC supply terminal 2. |
| Rating | 3A resistive @ 35V |

3.10 COMMUNICATION PORTS

| | |
|---|--|
| USB Port | USB2.0 Device for connection to PC running DSE configuration suite only Max distance 6m (20 feet) |
| Serial Communication (not available on DSE7200 series) | RS232 and RS485 are both fitted but do NOT provide independent operation |
| RS232 Serial port (not available on DSE7200 series) | Non – Isolated port Max Baud rate 115K baud subject to S/W TX, RX, RTS, CTS, DSR, DTR, DCD Male 9 way D type connector Max distance 15m (50 feet) |
| RS485 Serial port (not available on DSE7200 series) | Isolated Data connection 2 wire + common Half Duplex Data direction control for Transmit (by s/w protocol) Max Baud Rate 19200 External termination required (120Ω) Max common mode offset 70V (on board protection transorb) Max distance 1.2km (¾ mile) |
| CAN Port | Engine CAN Port Standard implementation of ‘Slow mode’, up to 250K bits/s Non-Isolated. Internal Termination provided (120Ω) Max distance 40m (133 feet) |

3.11 COMMUNICATION PORT USAGE

3.11.1 CAN INTERFACE

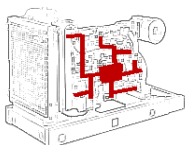

Modules are fitted with the CAN interface as standard and are capable of receiving engine data from engine CAN controllers compliant with the CAN standard. CAN enabled engine controllers monitor the engine's operating parameters such as engine speed, oil pressure, engine temperature (among others) in order to closely monitor and control the engine. The industry standard communications interface (CAN) transports data gathered by the engine controller interface. This allows generator controllers such as the DSE7000 series to access these engine parameters with no physical connection to the sensor device.

NOTE: - For further details for connections to CAN enabled engines and the functions available with each engine type, refer to the manual *Electronic Engines and DSE Wiring. Part No. 057-004*

3.11.2 USB CONNECTION

The USB port is provided to give a simple means of connection between a PC and the DSE7000 series controller. Using the DSE Configuration Suite Software, the operator is then able to control the module, starting or stopping the generator, selecting operating modes, etc.

Additionally, the various operating parameters (such as output volts, oil pressure, etc.) of the remote generator are available to be viewed or changed.

To connect a DSE7000 series module to a PC by USB, the following items are required:

- DSE7200 or DSE73000 series module



- DSE 7000 series configuration software
(Supplied on configuration suite software CD or available from www.deepseapl.com).



- USB cable Type A to Type B.
(This is the same cable as often used between a PC and a USB printer)



DSE can supply this cable if required :

PC Configuration interface lead (USB type A – type B) DSE Part No 016-125

NOTE: - The DC supply must be connected to the module for configuration by PC.

NOTE: - Refer to DSE7000 series Configuration Suite Manual for further details on configuring, monitoring and control.

3.11.3 RS232

The RS232 port on the controller supports the Modbus RTU protocol. The Gencomm register table for the controller is available upon request from the DSE Technical Support Department.

RS232 is for short distance communication (max 15m) and is typically used to connect the controller to a telephone or GSM modem for more remote communications.

Many PCs are not fitted with an internal RS232 serial port. DSE DOES NOT recommend the use of USB to RS232 convertors but can recommend PC add-ons to provide the computer with an RS232 port.

3.11.3.1 RECOMMENDED PC RS232 SERIAL PORT ADD-ONS

Remember to check these parts are suitable for your PC. Consult your PC supplier for further advice.

- Brainboxes PM143 PCMCIA RS232 card (for laptop PCs)
- Brainboxes VX-001 Express Card RS232 (for laptops and nettops PCs)
- Brainboxes UC246 PCI RS232 card (for desktop PCs)
- Brainboxes PX-246 PCI Express 1 Port RS232 1 x 9 Pin (for desktop PCs)



Supplier:

Brainboxes

Tel: +44 (0)151 220 2500

Web: <http://www.brainboxes.com>

Email: Sales: sales@brainboxes.com

NB DSE Have no business tie to Brainboxes. Over many years, our own engineers have used these products and are happy to recommend them.

3.11.3.2 RECOMMENDED EXTERNAL MODEMS:

- Multitech Global Modem – MultiModem ZBA (PSTN)
DSE Part Number 020-252
(Contact DSE Sales for details of localisation kits for these modems)



- Sierra Fastrak Xtend GSM modem kit (PSU, Antenna and modem)*
DSE Part number 0830-001-01



▲ NOTE: *For GSM modems a SIM card is required, supplied by your GSM network provider :

- For SMS only, a 'normal' voice SIM card is required. This enables the controller to send SMS messages to designated mobile phones upon status and alarm conditions.
- For a data connection to a PC running DSE Configuration Suite Software, a 'special' CSD (Circuit Switched Data) SIM card is required that will enable the modem to answer an incoming data call. Many 'pay as you go' services will not provide a CSD (Circuit Switched Data) SIM card.

3.11.4 RS485

The RS485 port on the series controller supports the Modbus RTU protocol. The DSE Gencomm register table for the controller is available upon request from the DSE Technical Support Department.

RS485 is used for point-to-point cable connection of more than one device (maximum 32 devices) and allows for connection to PCs, PLCs and Building Management Systems (to name just a few devices).

One advantage of the RS485 interface is the large distance specification (1.2km when using Belden 9841 (or equivalent) cable. This allows for a large distance between the module and a PC running the DSE Configuration Suite software. The operator is then able to control the module, starting or stopping the generator, selecting operating modes, etc.

The various operating parameters (such as output volts, oil pressure, etc.) of the remote generator can be viewed or changed.

NOTE:- For a single module to PC connection and distances up to 6m (8yds) the USB connection method is more suitable and provides for a lower cost alternative to RS485 (which is more suited to longer distance connections).

3.11.4.1 RECOMMENDED PC RS485 SERIAL PORT ADD-ONS

Remember to check these parts are suitable for your PC. Consult your PC supplier for further advice.

- Brainboxes PM154 PCMCIA RS485 card (for laptops PCs)
Set to 'Half Duplex, Autogating" with 'CTS True' set to 'enabled'
- Brainboxes VX-023 ExpressCard 1 Port RS422/485 (for laptops and nettop PCs)
- Brainboxes UC320 PCI Velocity RS485 card (for desktop PCs)
Set to 'Half Duplex, Autogating" with 'CTS True' set to 'enabled'
- Brainboxes PX-324 PCI Express 1 Port RS422/485 (for desktop PCs)



Supplier:

Brainboxes

Tel: +44 (0)151 220 2500

Web: <http://www.brainboxes.com>

Email: Sales: sales@brainboxes.com

NB DSE have no business tie to Brainboxes. Over many years,our own engineers have used these products and are happy to recommend them.

3.12 DSENET® FOR EXPANSION MODULES

DSENet® is the interconnection cable between the host controller and the expansion module(s) and must not be connect to any device other than DSE equipment designed for connection to the DSENet®

NOTE: DSENet® is not available on DSE7200 series controllers.

| | |
|--------------------------------|--|
| Cable type | Two core screened twisted pair |
| Cable characteristic impedance | 120Ω |
| Recommended cable | Belden 9841 Belden 9271 |
| Maximum cable length | 1200m (¾ mile) when using Belden 9841 or direct equivalent. 600m (666 yds) when using Belden 9271 or direct equivalent. |
| DSENet® topology | “Daisy Chain” Bus with no stubs (spurs) |
| DSENet® termination | 120Ω. Fitted internally to host controller. Must be fitted externally to the ‘last’ expansion module by the customer. |
| Maximum expansion modules | Refer to host controller documentation. |

NOTE : As a termination resistor is internally fitted to the host controller, the host controller must be the ‘first’ unit on the DSENet®. A termination resistor MUST be fitted to the ‘last’ unit on the DSENet®. For connection details, you are referred to the section entitled ‘typical wiring diagram’ elsewhere in this document.

3.12.1 DSENET® USED FOR MODBUS ENGINE CONNECTION

As DSENet® utilises an RS485 hardware interface, this port can be configured for connection to Cummins Modbus engines (Engines fitted with Cummins GCM (Generator Control Module)).

This leaves the RS485 interface free for connection to remote monitoring equipment (i.e. Building Management System, PLC or PC RS485 port).

While this is a very useful feature in some applications, the obvious drawback is that the DSENet® interface is no longer available for connection to expansion devices.

Example of configuring the DSENet® for connection to Cummins QST GMC using the DSE Configuration Suite Software:

ECU (ECM) Options

| | |
|--------------------------|--------------------------|
| Engine Type | Cummins QST ▾ |
| Enhanced J1939 | <input type="checkbox"/> |
| Alternative Engine Speed | <input type="checkbox"/> |
| Modbus Engine Comms Port | DSENet Port ▾ |

3.13 SOUNDER

DSE7000 Series features an internal sounder to draw attention to warning, shutdown and electrical trip alarms.

| | |
|---------------|-----------|
| Sounder level | 64db @ 1m |
|---------------|-----------|

3.13.1 ADDING AN EXTERNAL SOUNDER TO THE APPLICATION

Should an external alarm or indicator be required, this can be achieved by using the DSE Configuration Suite PC software to configure an auxiliary output for “Audible Alarm”, and by configuring an auxiliary input for “Alarm Mute” (if required).

The audible alarm output activates and de-activates at the same time as the module’s internal sounder. The Alarm mute input and internal alarm mute button activate ‘in parallel’ with each other. Either signal will mute both the internal sounder and audible alarm output.

Example of configuration to achieve external sounder with external alarm mute button:

The screenshot shows two configuration panels. The first panel, titled "Relay Outputs (DC Supply Out)", has a table with two columns: "Source" and "Polarity". Under "Source", "Output E" is set to "Audible Alarm". Under "Polarity", "Output E" is set to "Energise". The second panel, titled "Digital Input A", has a "Function" dropdown menu set to "Alarm Mute".

3.14 ACCUMULATED INSTRUMENTATION

NOTE: When an accumulated instrumentation value exceeds the maximum number as listed below, it will reset and begin counting from zero again.

| | |
|------------------|--|
| Engine hours run | Maximum 99999 hrs 59 minutes (approximately 11yrs 4months) |
| Number of starts | 1,000,000 (1 million) |

The number of logged Engine Hours and Number of Starts can be set/reset using the DSE Configuration Suite PC software. Depending upon module configuration, this may have been PIN number locked by your generator supplier

3.15 DIMENSIONS AND MOUNTING

DIMENSIONS

240.0mm x 181.1mm x 41.7mm (9.4" x 7.1" x 1.6")

PANEL CUTOUT

220mm x 160mm (8.7" x 6.3")

WEIGHT

0.7kg (1.4lb)

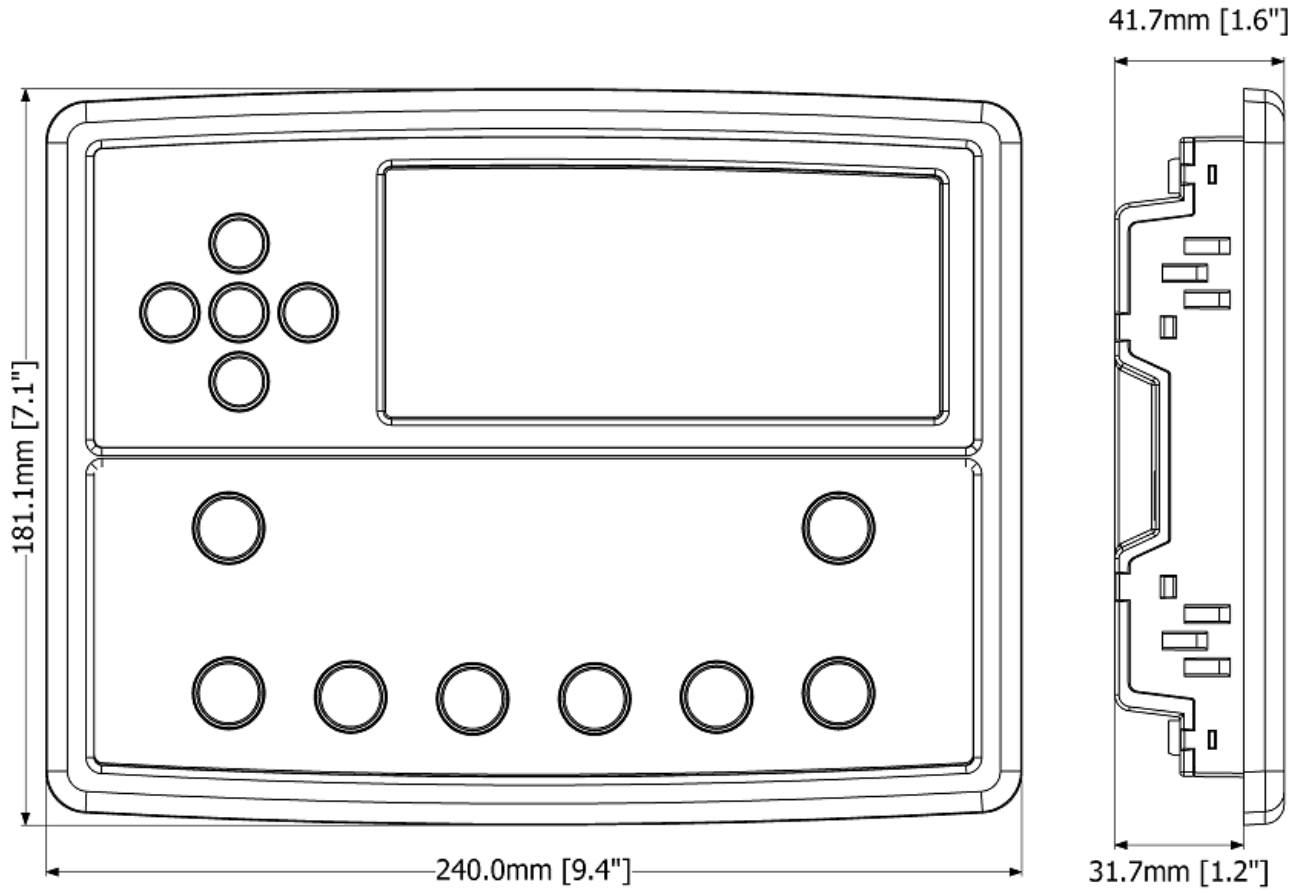

3.15.1 FIXING CLIPS

Supplied fixing clips hold the module into the panel fascia.

Withdraw the fixing clip screw (turn anticlockwise) until only the pointed end is protruding from the clip.

- Insert the three 'prongs' of the fixing clip into the slots in the side of the 7000 series module case.
- Pull the fixing clip backwards (towards the back of the module) ensuring all three prongs of the clip are inside their allotted slots.
- Turn the fixing clip screws clockwise until they make contact with the panel fascia.
- Turn the screws a little more to secure the module into the panel fascia. Take care not to over tighten the fixing clip screws.

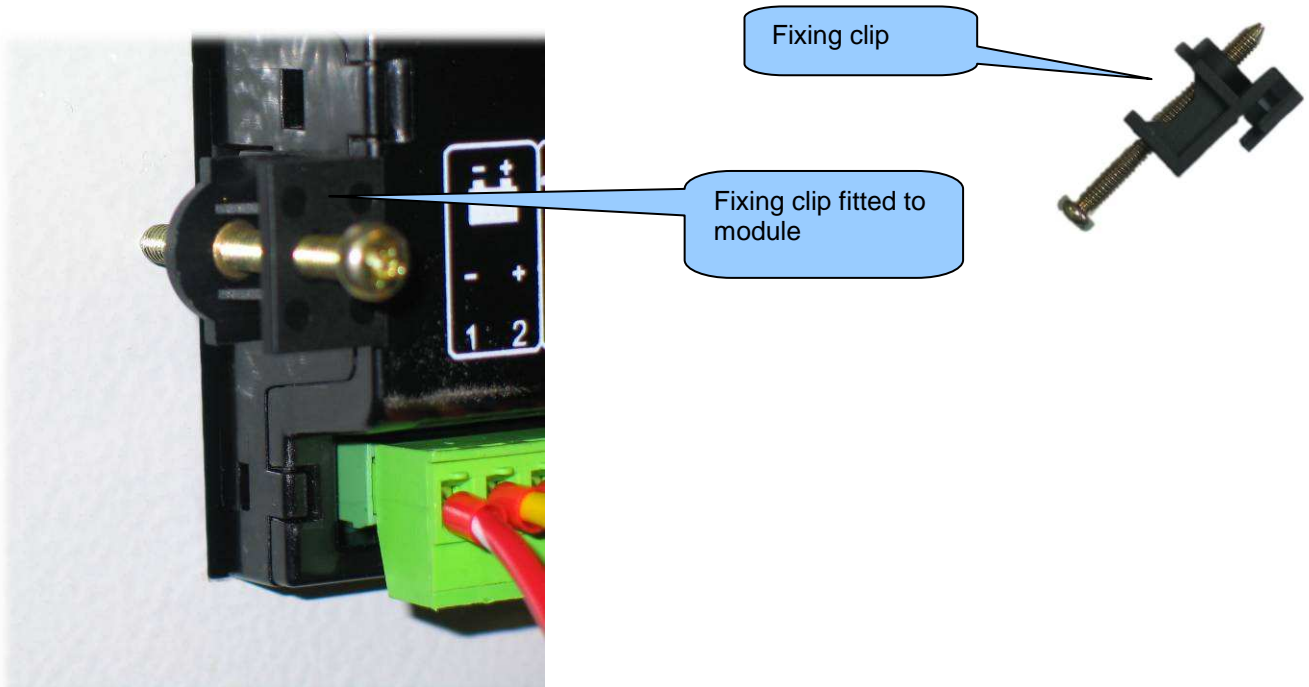

NOTE:- In conditions of excessive vibration, mount the module on suitable anti-vibration mountings.

3.15.2 CABLE TIE FIXING POINTS

Integral cable tie fixing points are included on the rear of the module's case to aid wiring. This additionally provides strain relief to the cable loom by removing the weight of the loom from the screw connectors, thus reducing the chance of future connection failures.

Care should be taken not to overtighten the cable tie (for instance with cable tie tools) to prevent the risk of damage to the module case.



Cable tie fixing point

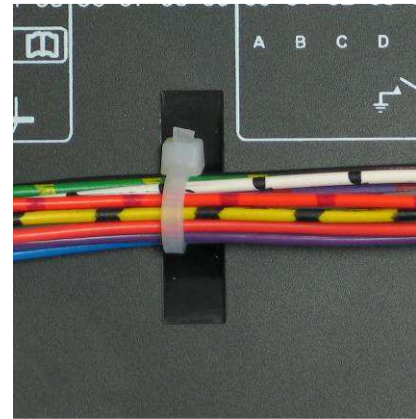

With cable and tie in place

3.15.3 SILICON SEALING GASKET

The supplied silicon gasket provides improved sealing between the 7000 series module and the panel fascia. The gasket is fitted to the module before installation into the panel fascia.

Take care to ensure the gasket is correctly fitted to the module to maintain the integrity of the seal.

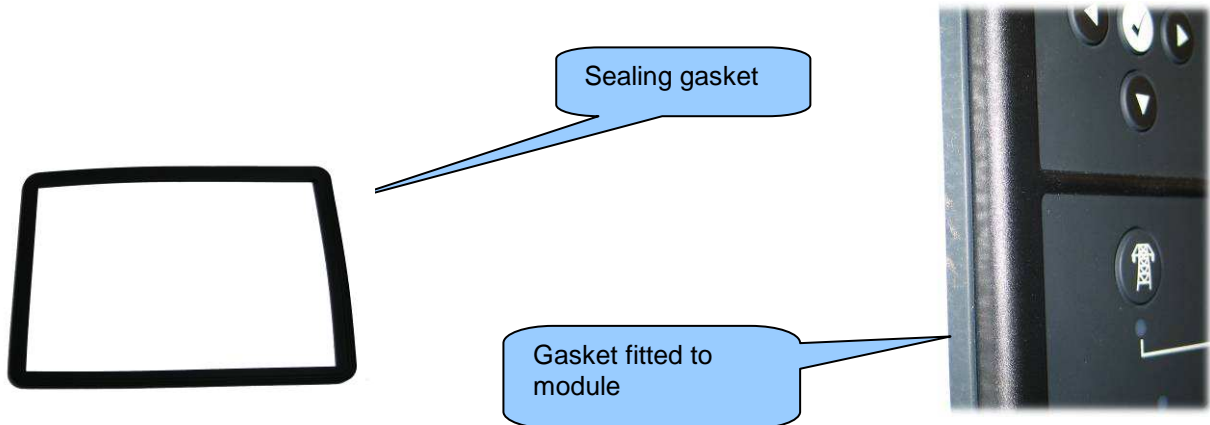

3.16 APPLICABLE STANDARDS

| | |
|--|---|
| BS 4884-1 | This document conforms to BS4884-1 1992 Specification for presentation of essential information. |
| BS 4884-2 | This document conforms to BS4884-2 1993 Guide to content |
| BS 4884-3 | This document conforms to BS4884-3 1993 Guide to presentation |
| BS EN 60068-2-1 (Minimum temperature) | -30°C (-22°F) |
| BS EN 60068-2-2 (Maximum temperature) | +70°C (158°F) |
| BS EN 60950 | Safety of information technology equipment, including electrical business equipment |
| BS EN 61000-6-2 | EMC Generic Immunity Standard (Industrial) |
| BS EN 61000-6-4 | EMC Generic Emission Standard (Industrial) |
| BS EN 60529 (Degrees of protection provided by enclosures) (see overleaf) | IP65 (front of module when installed into the control panel with the supplied sealing gasket) IP42 (front of module when installed into the control panel WITHOUT being sealed to the panel) |
| UL508 NEMA rating (Approximate) (see overleaf) | 12 (Front of module when installed into the control panel with the supplied sealing gasket). 2 (Front of module when installed into the control panel WITHOUT being sealed to the panel) |
| IEEE C37.2 (Standard Electrical Power System Device Function Numbers and Contact Designations) | <p>Under the scope of IEEE 37.2, <i>function numbers can also be used to represent functions in microprocessor devices and software programs.</i></p> <p>The controller is device number 11L-8000 (Multifunction device protecting Line (generator) –module).</p> <p>As the module is configurable by the generator OEM, the functions covered by the module will vary. Under the module's factory configuration, the device numbers included within the module are :</p> <ul style="list-style-type: none"> 2 – Time delay starting or closing relay 3 – Checking or interlocking relay 5 – Stopping Device 6 – Starting circuit breaker 8 – Control power disconnecting device 10 – Unit sequence switch 11 – Multifunction device 12 – Overspeed device 14 – Underspeed device 23 – Temperature control device 26 – Apparatus thermal device 27AC – AC undervoltage relay 27DC – DC undervoltage relay 29 – Isolating contactor or switch 30 – Annunciator relay 31 – Separate Excitation Device 37 – Undercurrent or underpower relay (USING INTERNAL PLC EDITOR) 41 – Field circuit breaker 42 – Running circuit breaker 44 – Unit sequence relay 46 – Reverse-phase or phase-balance current relay 48 – Incomplete sequence relay 49 – Machine or transformer thermal relay |

Continued overleaf.

| | |
|--|---|
| IEEE C37.2 (Standard Electrical Power System Device Function Numbers and Contact Designations) | Continued... 50 – Instantaneous overcurrent relay 51 – AC time overcurrent relay 52 – AC circuit breaker 53 – Exciter or DC generator relay 54 – Turning gear engaging device 55 – Power factor relay (USING INTERNAL PLC EDITOR) 59AC – AC overvoltage relay 59DC – DC overvoltage relay 62 – Time delay stopping or opening relay 63 – Pressure switch 71 – Level switch 74 – Alarm relay 78 – Phase-angle measuring relay 79 – Reclosing relay (USING INTERNAL PLC EDITOR) 81 – Frequency relay 83 – Automatic selective control or transfer relay 86 – Lockout relay |
|--|---|

In line with our policy of continual development, Deep Sea Electronics, reserve the right to change specification without notice.

3.16.1 ENCLOSURE CLASSIFICATIONS

IP CLASSIFICATIONS

7000 series specification under BS EN 60529 Degrees of protection provided by enclosures

| IP65 (Front of module when module is installed into the control panel with the optional sealing gasket). | |
|--|--|
| IP42 (front of module when module is installed into the control panel WITHOUT being sealed to the panel) | |
| First Digit | Second Digit |
| Protection against contact and ingress of solid objects | Protection against ingress of water |
| 0 No protection | 0 No protection |
| 1 Protected against ingress solid objects with a diameter of more than 50 mm. No protection against deliberate access, e.g. with a hand, but large surfaces of the body are prevented from approach. | 1 Protection against dripping water falling vertically. No harmful effect must be produced (vertically falling drops). |
| 2 Protected against penetration by solid objects with a diameter of more than 12 mm. Fingers or similar objects prevented from approach. | 2 Protection against dripping water falling vertically. There must be no harmful effect when the equipment (enclosure) is tilted at an angle up to 15° from its normal position (drops falling at an angle). |
| 3 Protected against ingress of solid objects with a diameter of more than 2.5 mm. Tools, wires etc. with a thickness of more than 2.5 mm are prevented from approach. | 3 Protection against water falling at any angle up to 60° from the vertical. There must be no harmful effect (spray water). |
| 4 Protected against ingress of solid objects with a diameter of more than 1 mm. Tools, wires etc. with a thickness of more than 1 mm are prevented from approach. | 4 Protection against water splashed against the equipment (enclosure) from any direction. There must be no harmful effect (splashing water). |
| 5 Protected against harmful dust deposits. Ingress of dust is not totally prevented but the dust must not enter in sufficient quantity to interfere with satisfactory operation of the equipment. Complete protection against contact. | 5 Protection against water projected from a nozzle against the equipment (enclosure) from any direction. There must be no harmful effect (water jet). |
| 6 Protection against ingress of dust (dust tight). Complete protection against contact. | 6 Protection against heavy seas or powerful water jets. Water must not enter the equipment (enclosure) in harmful quantities (splashing over). |

3.16.2 NEMA CLASSIFICATIONS

7000 series NEMA Rating (Approximate)

12 (Front of module when module is installed into the control panel with the optional sealing gasket).

2 (front of module when module is installed into the control panel WITHOUT being sealed to the panel)

 **NOTE: - There is no direct equivalence between IP / NEMA ratings. IP figures shown are approximate only.**

| | |
|-----------------------|--|
| 1 IP30 | Provides a degree of protection against contact with the enclosure equipment and against a limited amount of falling dirt. |
| 2 IP31 | Provides a degree of protection against limited amounts of falling water and dirt. |
| 3 IP64 | Provides a degree of protection against windblown dust, rain and sleet; undamaged by the formation of ice on the enclosure. |
| 3R IP32 | Provides a degree of protection against rain and sleet; undamaged by the formation of ice on the enclosure. |
| 4 (X) IP66 | Provides a degree of protection against splashing water, windblown dust and rain, hose directed water; undamaged by the formation of ice on the enclosure. (Resist corrosion). |
| 12/12K IP65 | Provides a degree of protection against dust, falling dirt and dripping non corrosive liquids. |
| 13 IP65 | Provides a degree of protection against dust and spraying of water, oil and non corrosive coolants. |

4 INSTALLATION

The DSE7000 Series module is designed to be mounted on the panel fascia. For dimension and mounting details, see the section entitled *Specification, Dimension and mounting* elsewhere in this document.

4.1 USER CONNECTIONS





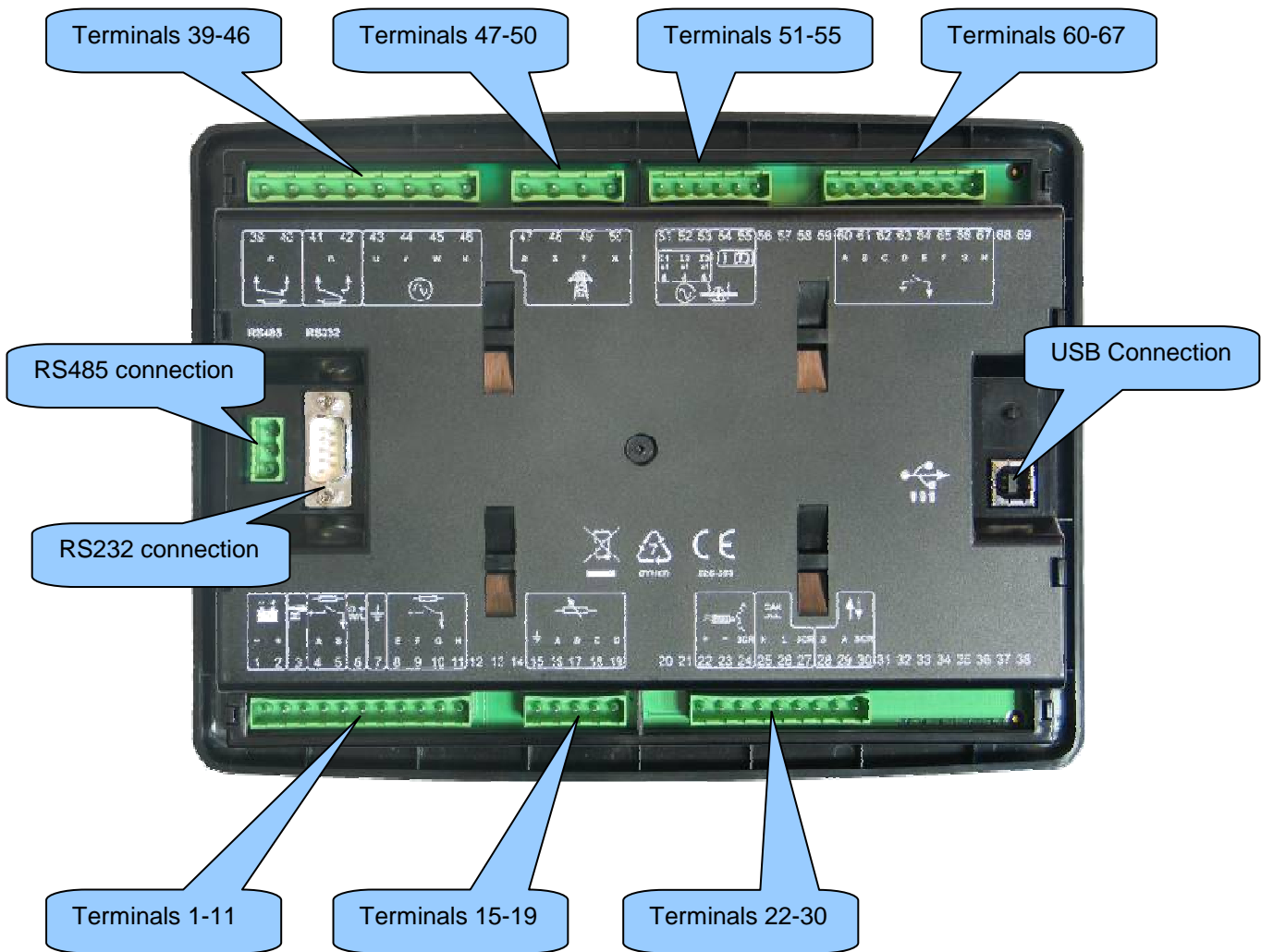

To aid user connection, icons on the rear of the module ease Identification of terminal functions.

NOTE : Availability of some terminals depends upon module version. The section entitled *Terminal Description* elsewhere in this manual details this further.



4.2 TERMINAL DESCRIPTION

4.2.1 DC SUPPLY, FUEL AND START OUTPUTS

| Icon | PIN No | DESCRIPTION | CABLE SIZE | NOTES |
|---|--------|----------------------------------|-------------------------------|--|
|  | 1 | DC Plant Supply Input (Negative) | 2.5mm ² AWG 13 | |
| | 2 | DC Plant Supply Input (Positive) | 2.5 mm ² AWG 13 | (Recommended Maximum Fuse 15A anti-surge) Supplies the module (2A anti-surge requirement) and Output relays E,F,G & H |
|  | 3 | Emergency Stop Input | 2.5mm ² AWG 13 | Plant Supply Positive. Also supplies outputs 1 & 2. (Recommended Maximum Fuse 20A) |
|  | 4 | Output relay A (FUEL) | 2.5mm ² AWG 13 | Plant Supply Positive from terminal 3. 15 Amp rated. Fixed as FUEL relay if electronic engine is not configured. |
| | 5 | Output relay B (START) | 2.5mm ² AWG 13 | Plant Supply Positive from terminal 3. 15 Amp rated. Fixed as START relay if electronic engine is not configured. |
|  | 6 | Charge fail / excite | 2.5mm ² AWG 13 | Do not connect to ground (battery negative). If charge alternator is not fitted, leave this terminal disconnected. |
|  | 7 | Functional Earth | 2.5mm ² AWG 13 | Connect to a good clean earth point. |
|  | 8 | Output relay E | 1.0mm ² AWG 18 | Plant Supply Positive from terminal 2. 3 Amp rated. |
| | 9 | Output relay F | 1.0mm ² AWG 18 | Plant Supply Positive from terminal 2. 3 Amp rated. |
| | 10 | Output relay G | 1.0mm ² AWG 18 | Plant Supply Positive. from terminal 2. 3 Amp rated. |
| | 11 | Output relay H | 1.0mm ² AWG 18 | Plant Supply Positive from terminal 2. 3 Amp rated. |

NOTE:- Terminals 12 to 14 are not fitted to the DSE7200/DSE7300 series controller.

NOTE:- When the module is configured for operation with an electronic engine, FUEL and START output requirements may be different. Refer to *Electronic Engines and DSE Wiring* for further information. DSE Part No. 057-004.

4.2.2 ANALOGUE SENSORS



| PIN No | DESCRIPTION | CABLE SIZE | NOTES |
|--------|--|------------------------------|--|
| 15 | Sensor Common Return | 0.5mm ² AWG 20 | Return feed for sensors |
| 16 | Oil Pressure Input | 0.5mm ² AWG 20 | Connect to Oil pressure sensor |
| 17 | Coolant Temperature Input | 0.5mm ² AWG 20 | Connect to Coolant Temperature sensor |
| 18 | Fuel Level input | 0.5mm ² AWG 20 | Connect to Fuel Level sensor |
| 19 | Flexible sensor (not available on 7200 series controller) | 0.5mm ² AWG 20 | Connect to additional sensor (user configurable) |

NOTE:- Terminals 20 and 21 are not fitted to the 7200/7300 series controller.

NOTE:- . It is VERY important that terminal 15 (sensor common) is soundly connected to an earth point on the ENGINE BLOCK, not within the control panel, and must be a sound electrical connection to the sensor bodies. This connection MUST NOT be used to provide an earth connection for other terminals or devices. The simplest way to achieve this is to run a SEPERATE earth connection from the system earth star point, to terminal 15 directly, and not use this earth for other connections.

NOTE:- . If you use PTFE insulating tape on the sensor thread when using earth return sensors, ensure you do not insulate the entire thread, as this will prevent the sensor body from being earthed via the engine block.

4.2.3 MAGNETIC PICKUP, CAN AND EXPANSION

| | PIN No | DESCRIPTION | CABLE SIZE | NOTES |
|---|--------|--------------------------|------------------------------|------------------------------------|
|  | 22 | Magnetic pickup Positive | 0.5mm ² AWG 20 | Connect to Magnetic Pickup device |
| | 23 | Magnetic pickup Negative | 0.5mm ² AWG 20 | Connect to Magnetic Pickup device |
| | 24 | Magnetic pickup screen | Shield | Connect to ground at one end only |
|  | 25 | CAN port H | 0.5mm ² AWG 20 | Use only 120Ω CAN approved cable |
| | 26 | CAN port L | 0.5mm ² AWG 20 | Use only 120Ω CAN approved cable |
| | 27 | CAN port Common | 0.5mm ² AWG 20 | Use only 120Ω CAN approved cable |
|  | 28 | + | 0.5mm ² AWG 20 | Use only 120Ω RS485 approved cable |
| | 29 | - | 0.5mm ² AWG 20 | Use only 120Ω RS485 approved cable |
| | 30 | SCR | 0.5mm ² AWG 20 | Use only 120Ω RS485 approved cable |



 **NOTE:-** Terminals 31 to 38 are not fitted to the 7200 / 7300 controller

 **NOTE:-** Screened cable must be used for connecting the Magnetic Pickup, ensuring that the screen is earthed at one end ONLY.

 **NOTE:-** Screened 120Ω impedance cable specified for use with CAN must be used for the CAN link and the Multiset comms link.
DSE stock and supply Belden cable 9841 which is a high quality 120Ω impedance cable suitable for CAN use (DSE part number 016-030)

 **NOTE:-** When the module is configured for CAN operation, terminals 22, 23 & 24 should be left unconnected. Engine speed is transmitted to the 7000 series controller on the CAN link.
Refer to *Electronic Engines and DSE Wiring* for further information. Part No. 057-004.

4.2.4 LOAD SWITCHING AND GENERATOR VOLTAGE SENSING

| | PIN No | DESCRIPTION | CABLE SIZE | NOTES |
|--|--------|---|---------------------------|--|
|  | 39 | Output relay C | 1.0mm AWG 18 | Normally configured to control mains contactor coil (Recommend 10A fuse) |
| | 40 | Output relay C | 1.0mm AWG 18 | Normally configured to control mains contactor coil |
|  | 41 | Output relay D | 1.0mm AWG 18 | Normally configured to control generator contactor coil (Recommend 10A fuse) |
| | 42 | Output relay D | 1.0mm AWG 18 | Normally configured to control generator contactor coil |
|  | 43 | Generator L1 (U) voltage monitoring | 1.0mm ² AWG 18 | Connect to generator L1 (U) output (AC) (Recommend 2A fuse) |
| | 44 | Generator L2 (V) voltage monitoring input | 1.0mm ² AWG 18 | Connect to generator L2 (V) output (AC) (Recommend 2A fuse) |
| | 45 | Generator L3 (W) voltage monitoring input | 1.0mm ² AWG 18 | Connect to generator L3 (W) output (AC) (Recommend 2A fuse) |
| | 46 | Generator Neutral (N) input | 1.0mm ² AWG 18 | Connect to generator Neutral terminal (AC) |

NOTE:- The above table describes connections to a three phase, four wire alternator. For alternative wiring topologies, please see the **ALTERNATIVE AC TOPOLOGIES** section of this manual.

4.2.5 MAINS VOLTAGE SENSING

| | PIN No | DESCRIPTION | CABLE SIZE | NOTES |
|--|--------|---------------------------------|--------------|--|
|  | 47 | Mains L1 (R) voltage monitoring | 1.0mm AWG 18 | Connect to Mains L1 (R) incoming supply (AC) (Recommend 2A fuse) |
| | 48 | Mains L2 (S) voltage monitoring | 1.0mm AWG 18 | Connect to Mains L1 (S) incoming supply (AC) (Recommend 2A fuse) |
| | 49 | Mains L3 (T) voltage monitoring | 1.0mm AWG 18 | Connect to Mains L1 (T) incoming supply (AC) (Recommend 2A fuse) |
| | 50 | Mains Neutral (N) input | 1.0mm AWG 18 | Connect to Mains N incoming supply (AC) |

NOTE:- Terminals 47-50 are not fitted to the 7210 / 7310 controller.

4.2.6 GENERATOR CURRENT TRANSFORMERS

⚠ WARNING!:- Do not disconnect this plug when the CTs are carrying current. Disconnection will open circuit the secondary of the C.T.'s and dangerous voltages may then develop. Always ensure the CTs are not carrying current and the CTs are short circuit connected before making or breaking connections to the module.

⚠ NOTE:- The 7000 series module has a burden of 0.5VA on the CT. Ensure the CT is rated for the burden of the 7000 series controller, the cable length being used and any other equipment sharing the CT. If in doubt, consult your CT supplier.

⚠ NOTE:- Take care to ensure correct polarity of the CT primary as shown below. If in doubt, check with the CT supplier.

CT LABELLING

p1, κ or K is the primary of the CT that 'points' towards the GENERATOR

p2, ℓ or L is the primary of the CT that 'points' towards the LOAD

s1 is the secondary of the CT that connects to the DSE Module's input for the CT measuring (I1,I2,I3)

s2 is the secondary of the CT that should be commoned with the s2 connections of all the other CTs and connected to the CT common terminal of the DSE7000 series modules.

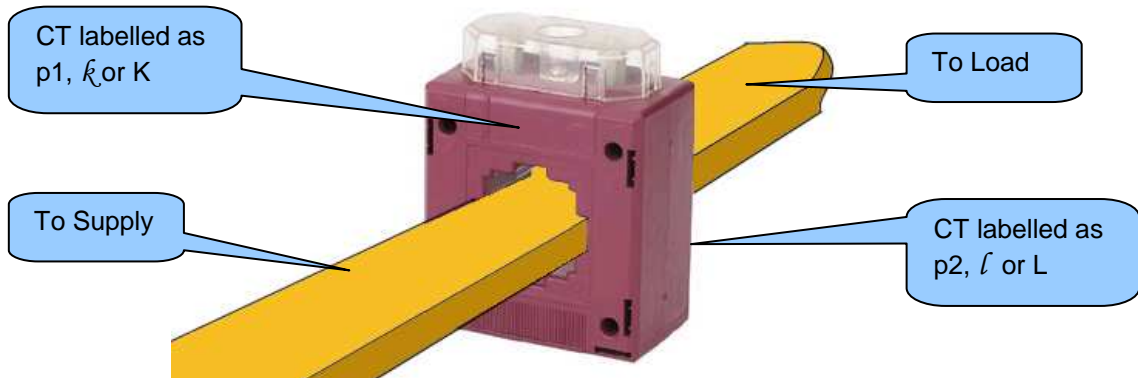

Connection of CT s1 terminal

| | PIN No | DESCRIPTION | CABLE SIZE | NOTES |
|--|--------|-------------------------|------------------------------|---|
|  | 51 | CT Secondary for Gen L1 | 2.5mm ² AWG 13 | Connect to s1 secondary of L1 monitoring CT |
| | 52 | CT Secondary for Gen L2 | 2.5mm ² AWG 13 | Connect to s1 secondary of L2 monitoring CT |
| | 53 | CT Secondary for Gen L3 | 2.5mm ² AWG 13 | Connect to s1 secondary of L3 monitoring CT |

Connection to terminals 54 & 55 (DSE7200 SERIES)

| | Pin No | Description | CABLE SIZE |
|--|--------|---|------------------------------|
|  | 54 | DO NOT CONNECT | |
| | 55 | Common for CTs connected to L1,L2,L3 (s2) | 2.5mm ² AWG 13 |

NOTE:- Terminals 56 to 59 are not fitted to the 7200 / 7300 series controller.

NOTE:- Take care to ensure correct polarity of the CT primary as shown overleaf. If in doubt, check with the CT supplier.

Connection to terminals 54 & 55 (DSE7300 SERIES)

The function of terminals 54 and 55 CHANGES depending upon what kind of earth fault protection (if any) is being used:

| | Topology | Pin No | Description | CABLE SIZE |
|--|--|--------|---|------------------------------|
|  | No earth fault measuring | 54 | DO NOT CONNECT | |
| | | 55 | Connect to s2 of the CTs connected to L1,L2,L3,N | 2.5mm ² AWG 13 |
| | Restricted earth fault measuring | 54 | Connect to s2 of the CTs connected to L1,L2,L3,N | 2.5mm ² AWG 13 |
| | | 55 | Connect to s1 of the CT on the neutral conductor | 2.5mm ² AWG 13 |
| | Un-restricted earth fault measuring (Earth fault CT is fitted in the neutral to earth link) | 54 | Connect to s1 of the CT on the neutral to earth conductor. | |
| | | 55 | Connect to s2 of the CT on the neutral to earth link. Also connect to the s2 of CTs connected to L1, L2, L3. | 2.5mm ² AWG 13 |

NOTE:- Terminals 56 to 59 are not fitted to the 7200 / 7300 series controller.



4.2.7 CONFIGURABLE DIGITAL INPUTS

| PIN No | DESCRIPTION | CABLE SIZE | NOTES |
|--------|--|------------------------------|--------------------|
| 60 | Configurable digital input A | 0.5mm ² AWG 20 | Switch to negative |
| 61 | Configurable digital input B | 0.5mm ² AWG 20 | Switch to negative |
| 62 | Configurable digital input C | 0.5mm ² AWG 20 | Switch to negative |
| 63 | Configurable digital input D | 0.5mm ² AWG 20 | Switch to negative |
| 64 | Configurable digital input E | 0.5mm ² AWG 20 | Switch to negative |
| 65 | Configurable digital input F | 0.5mm ² AWG 20 | Switch to negative |
| 66 | Configurable digital input G (not available on 7200 series) | 0.5mm ² AWG 20 | Switch to negative |
| 67 | Configurable digital input H (not available on 7200 series) | 0.5mm ² AWG 20 | Switch to negative |

NOTE:- Terminals 66 to 69 are not fitted to the 7200 series controller.

NOTE:- Terminals 68 and 69 are not fitted to the 7300 series controller.

4.2.8 PC CONFIGURATION INTERFACE CONNECTOR

| DESCRIPTION | CABLE SIZE | NOTES |
|---|------------------------------|--|
|  Socket for connection to PC with 7xxx series PC software. | 0.5mm ² AWG 20 | This is a standard USB type A to type B connector.  |

This configuration cable is the same as normally used between a PC and a USB printer!

NOTE:- The USB connection cable between the PC and the 7000 series module must not be extended beyond 5m (5yds). For distances over 5m, it is possible to use a third party USB extender. Typically, they extend USB up to 50m (yds). The supply and support of this type of equipment is outside the scope of Deep Sea Electronics PLC.

CAUTION! Care must be taken not to overload the PC's USB system by connecting more than the recommended number of USB devices to the PC. For further information, consult your PC supplier.

CAUTION! This socket must not be used for any other purpose.

4.2.9 RS485 CONNECTOR

NOTE:- RS485 connector is not fitted to the 7200 series controller.

| PIN No | NOTES |
|--------|---|
| A | Two core screened twisted pair cable. 120Ω impedance suitable for RS485 use. |
| B | Recommended cable type - Belden 9841 |
| SCR | Max distance 1000m (1km) when using Belden 9841 or direct equivalent. |

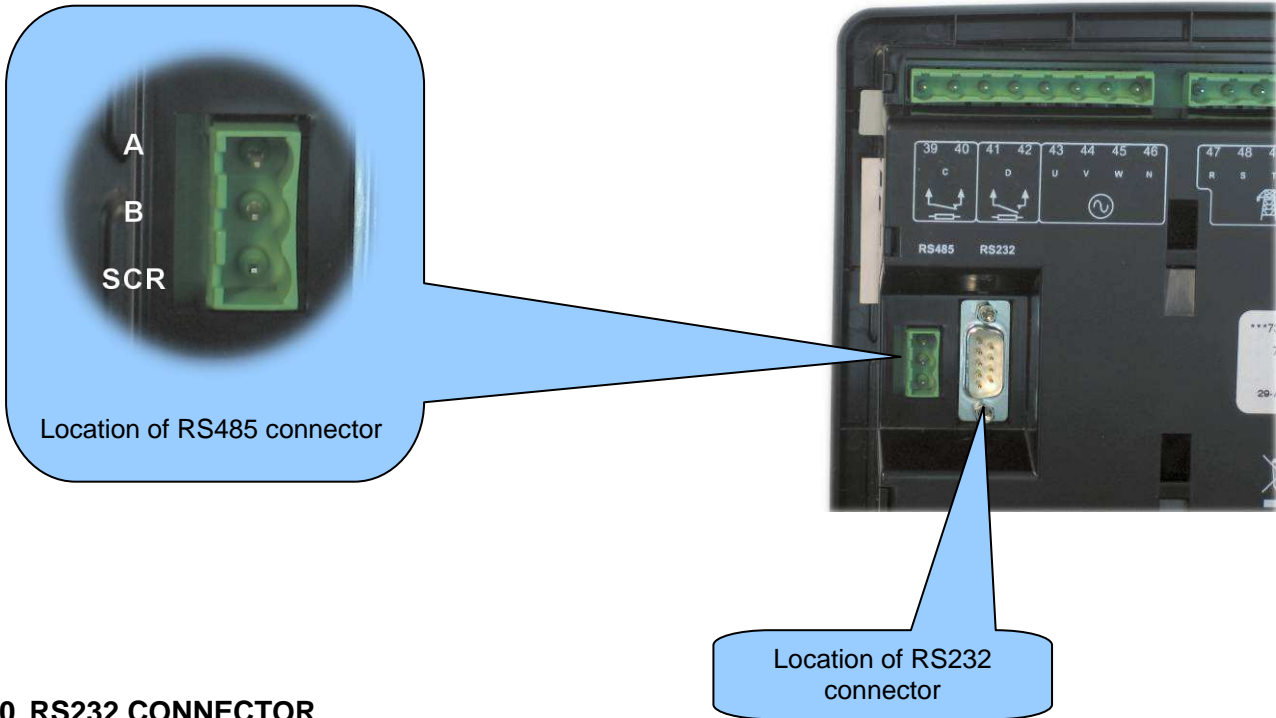

4.2.10 RS232 CONNECTOR

NOTE:- RS232 connector is not fitted to the 7200 series controller.

| PIN No | NOTES |
|--------|---|
| 1 | Received Line Signal Detector (Data Carrier Detect) |
| 2 | Received Data |
| 3 | Transmit Data |
| 4 | Data Terminal Ready |
| 5 | Signal Ground |
| 6 | Data Set Ready |
| 7 | Request To Send |
| 8 | Clear To Send |
| 9 | Ring Indicator |

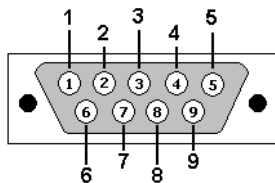

View looking into the male connector on the 7000 series module

4.3 TYPICAL WIRING DIAGRAMS

As every system has different requirements, these diagrams show only a TYPICAL system and do not intend to show a complete system.

Genset manufacturers and panel builders may use these diagrams as a starting point, however you are referred to the completed system diagram provided by your system manufacturer for complete wiring detail.

Further wiring suggestions are available in the following DSE publications, available at www.deepseapl.com to website members.

| DSE PART | DESCRIPTION |
|----------|-----------------------------------|
| 056-022 | Breaker Control (Training guide) |
| 057-004 | Electronic Engines and DSE Wiring |

4.3.1 7210 AUTOSTART CONTROLLER

3 phase, 4 wire

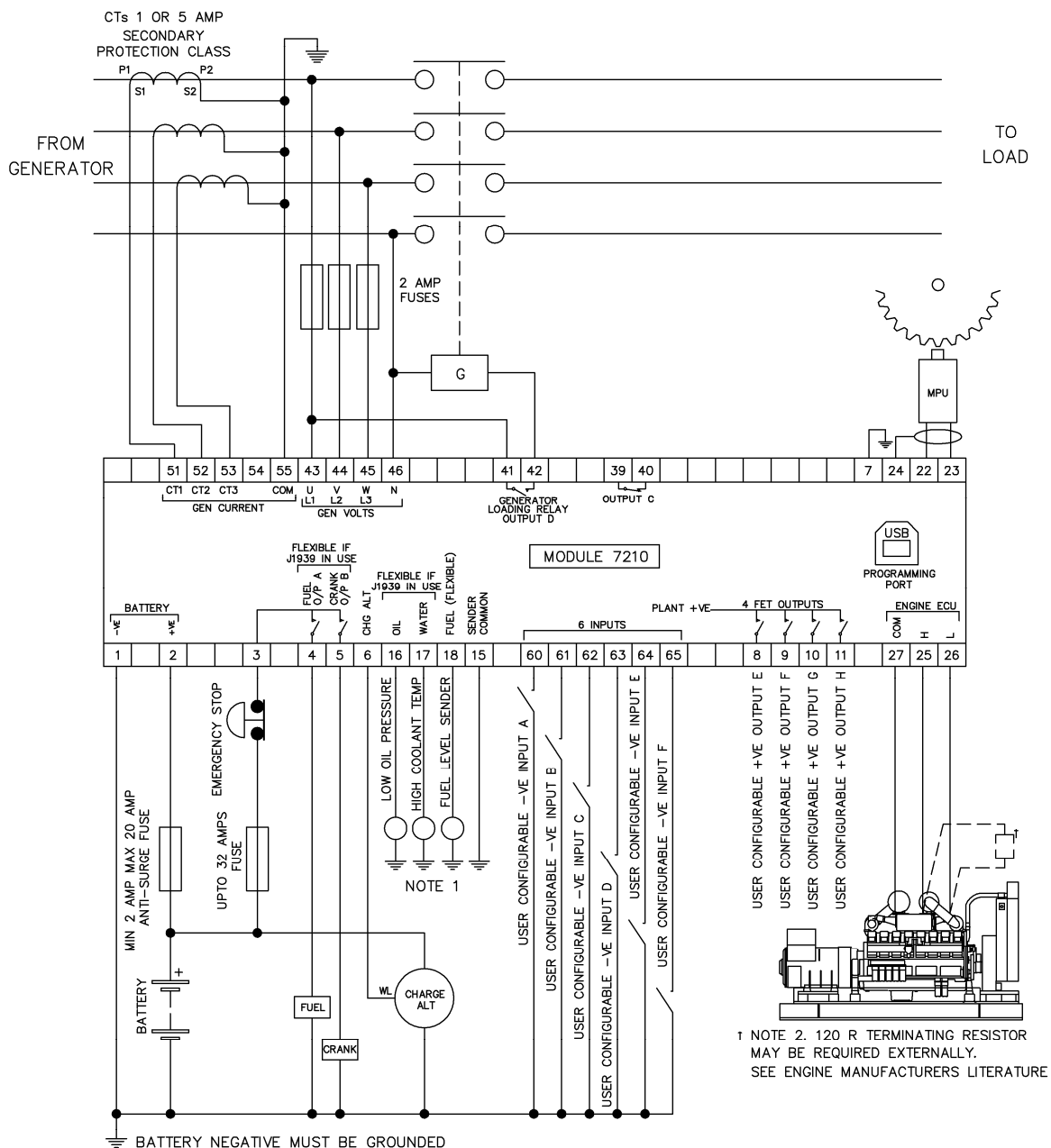

TERMINALS SUITABLE FOR 22-16 AWG (0.6mm - 1.3mm) FIELD WIRING

TIGHTENING TORQUE = 0.8Nm (7lb-in)

NOTE 1

THESE GROUND CONNECTIONS MUST BE ON THE ENGINE BLOCK, AND MUST BE TO THE SENDER BODIES.

THE GROUND WIRE TO TERMINAL 15 MUST NOT BE USED TO PROVIDE A GROUND CONNECTION TO ANY OTHER DEVICE

† NOTE 2. 120 R TERMINATING RESISTOR MAY BE REQUIRED EXTERNALLY. SEE ENGINE MANUFACTURERS LITERATURE

4.3.2 7220 AMF CONTROLLER

3 phase, 4 wire

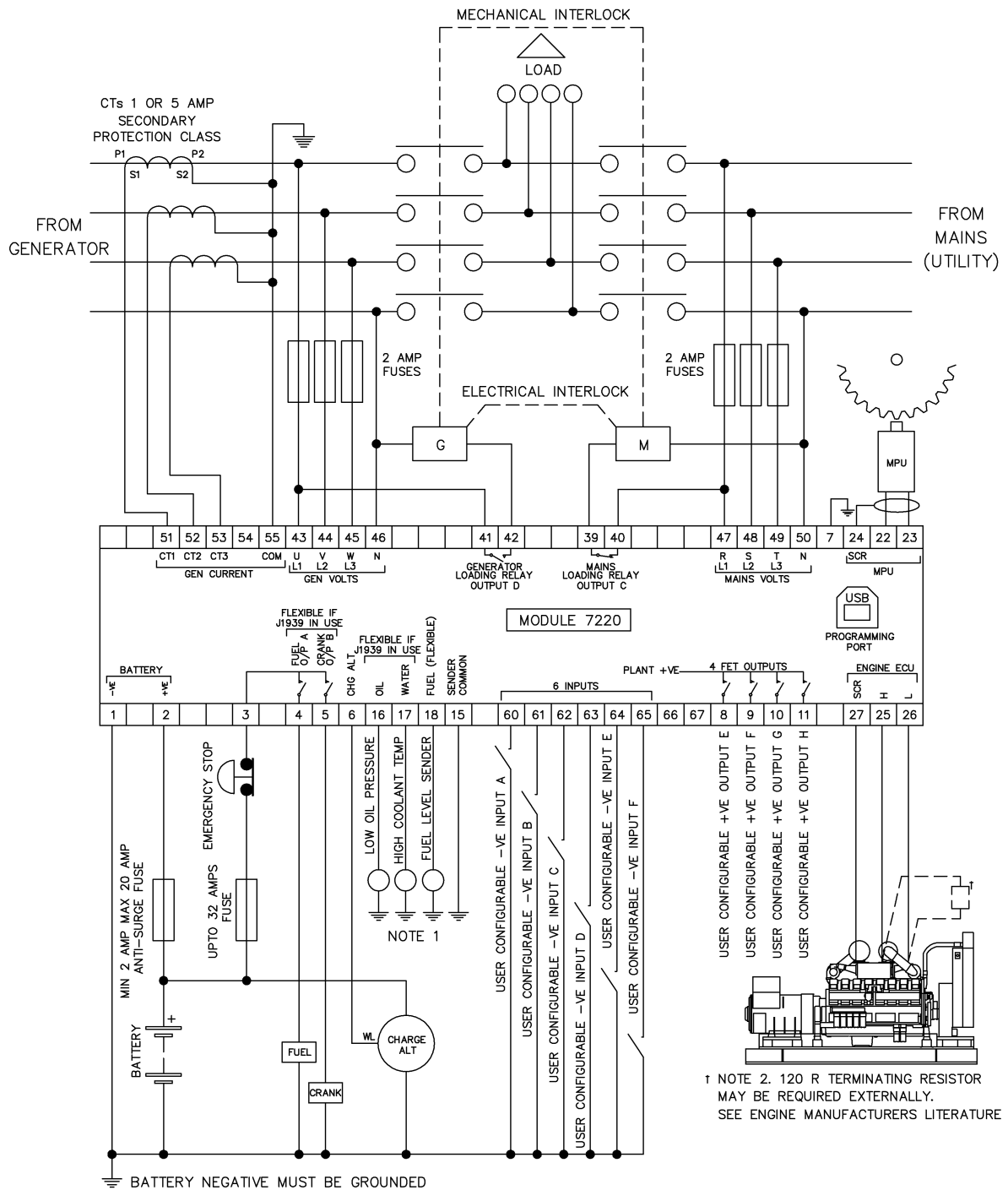

TERMINALS SUITABLE FOR 22-16 AWG (0.6mm - 1.3mm) FIELD WIRING

TIGHTENING TORQUE = 0.8Nm (7lb-in)

NOTE 1

THESE GROUND CONNECTIONS MUST BE ON THE ENGINE BLOCK, AND MUST BE TO THE SENDER BODIES.

THE GROUND WIRE TO TERMINAL 15 MUST NOT BE USED TO PROVIDE A GROUND CONNECTION TO ANY OTHER DEVICE

† NOTE 2. 120 R TERMINATING RESISTOR MAY BE REQUIRED EXTERNALLY. SEE ENGINE MANUFACTURERS LITERATURE

4.3.3 7310 AUTOSTART CONTROLLER

3 phase, 4 wire with restricted earth fault protection

NOTE:- Earthing the neutral conductor 'before' the neutral CT allows the module to read earth faults 'after' the CT only (Restricted to load / downstream of the CT)
 Earthing the neutral conductor 'after' the neutral CT allows the module to read earth faults 'before' the CT only (Restricted to generator / upstream of the CT)

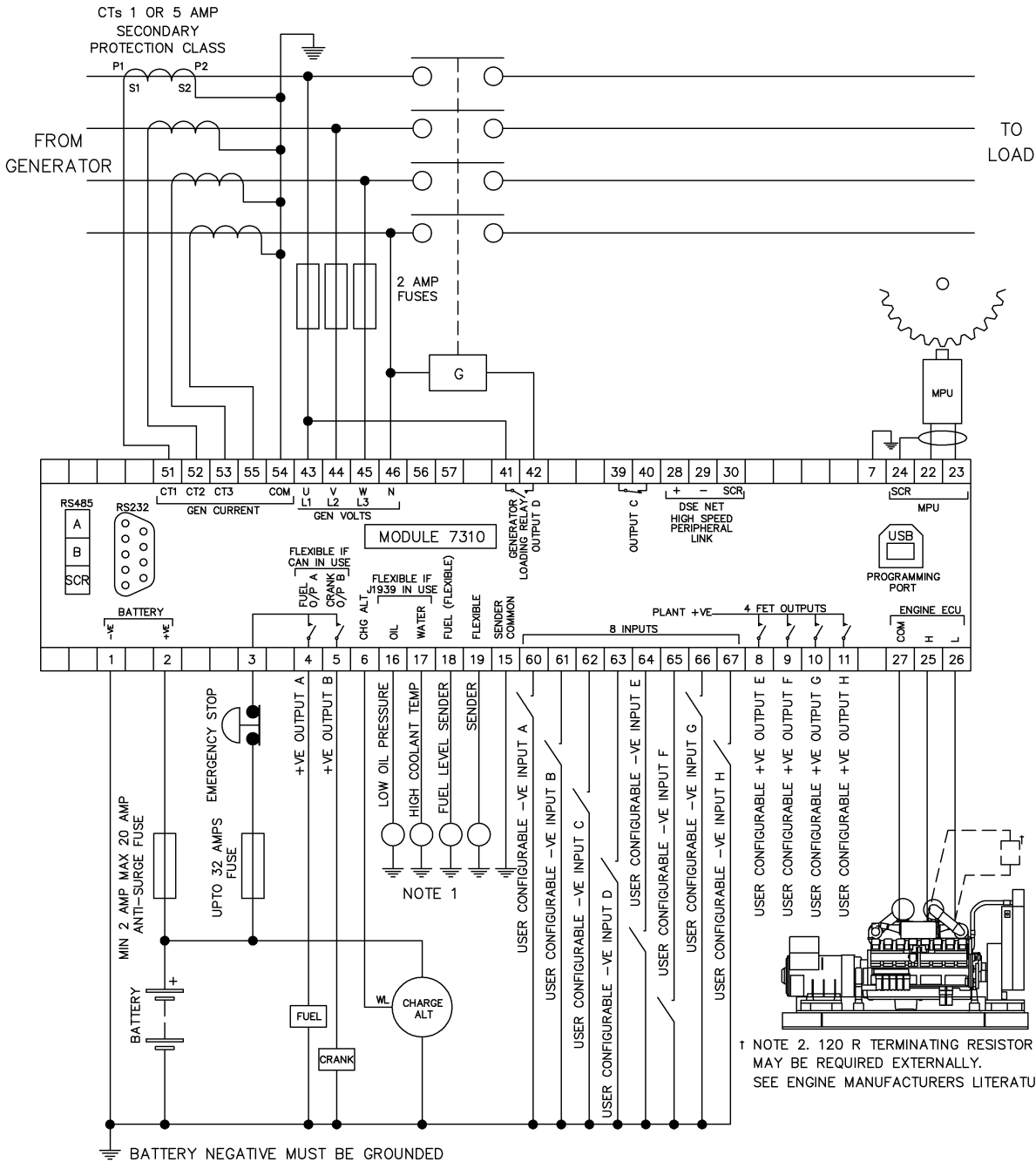

BATTERY NEGATIVE MUST BE GROUNDED
 TERMINALS SUITABLE FOR 22-16 AWG (0.6mm - 1.3mm) FIELD WIRING
 TIGHTENING TORQUE = 0.8Nm (7lb-in)

NOTE 1
 THESE GROUND CONNECTIONS MUST BE ON THE ENGINE BLOCK, AND MUST BE TO THE SENDER BODIES.
 THE GROUND WIRE TO TERMINAL 15 MUST NOT BE USED TO PROVIDE A GROUND CONNECTION TO ANY OTHER DEVICE

† NOTE 2. 120 R TERMINATING RESISTOR MAY BE REQUIRED EXTERNALLY. SEE ENGINE MANUFACTURERS LITERATURE

4.3.4 7320 AMF CONTROLLER

3 phase, 4 wire with restricted earth fault protection

NOTE:- Earthing the neutral conductor 'before' the neutral CT allows the module to read earth faults 'after' the CT only (Restricted to load / downstream of the CT)
 Earthing the neutral conductor 'after' the neutral CT allows the module to read earth faults 'before' the CT only (Restricted to generator / upstream of the CT)

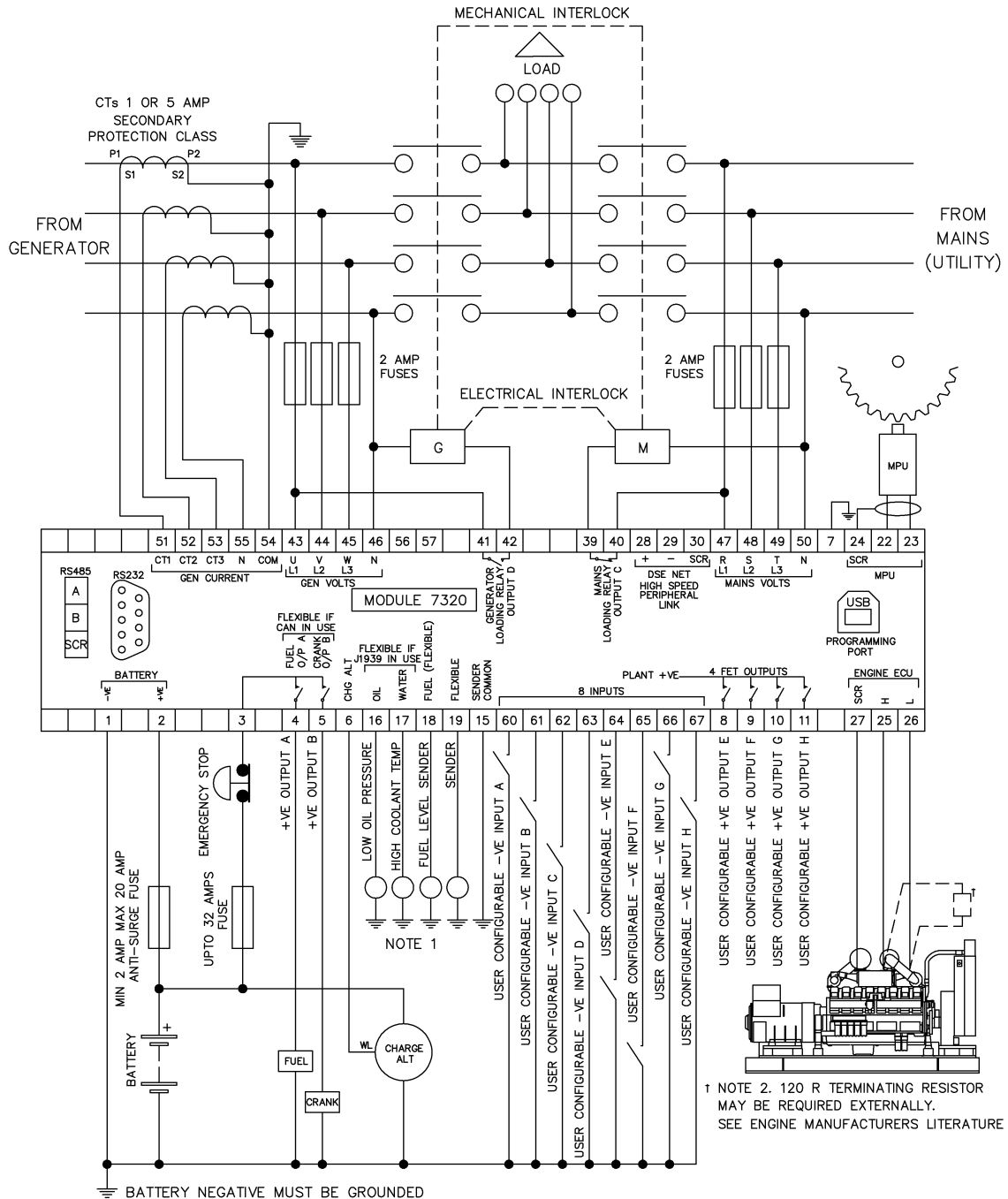

TERMINALS SUITABLE FOR 22-16 AWG (0.6mm - 1.3mm) FIELD WIRING TIGHTENING TORQUE = 0.8Nm (7lb-in)

NOTE 1
 THESE GROUND CONNECTIONS MUST BE ON THE ENGINE BLOCK, AND MUST BE TO THE SENDER BODIES.
 THE GROUND WIRE TO TERMINAL 15 MUST NOT BE USED TO PROVIDE A GROUND CONNECTION TO ANY OTHER DEVICE

† NOTE 2. 120 R TERMINATING RESISTOR MAY BE REQUIRED EXTERNALLY. SEE ENGINE MANUFACTURERS LITERATURE

4.3.5 DSENET®

NOTE: - This feature is only available on DSE7300 Series modules

DSENet® is the communication port between the host controller (DSE7300 series) and the expansion device as shown below. Further details are contained within the *Specification* section of this documents and within the operator manual for the specific expansion module you are connecting to.

NOTE: - This feature is not available if the DSE7300 Series module has been configured to use the DSENet® port as the interface to Cummins Modbus Engine GCM.

NOTE:- Screened 120Ω impedance cable specified for use with CAN must be used for the DSENet® (RS485) connection.

DSE stock and supply Belden cable 9841 which is a high quality 120Ω impedance cable suitable for DSENet® use (DSE part number 016-030)

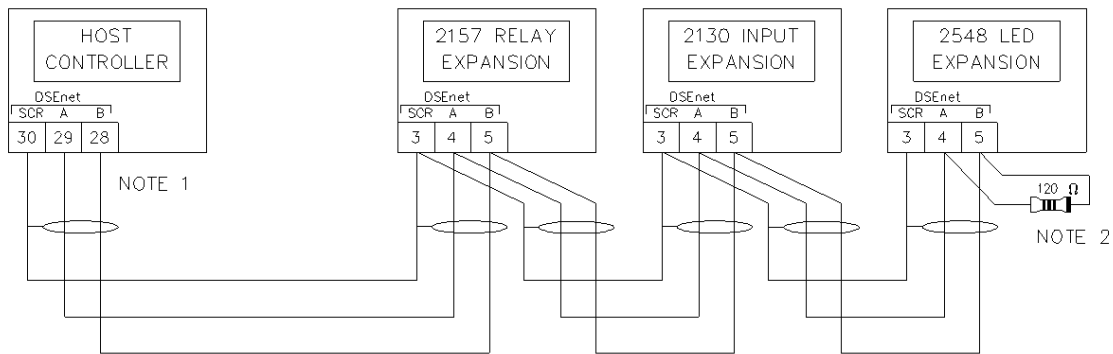

NOTE 1
AS A TERMINATING RESISTOR IS INTERNALLY FITTED TO THE HOST CONTROLLER, THE HOST CONTROLLER MUST BE THE FIRST UNIT ON THE DSEnet

NOTE 2
A 120 OHM TERMINATION RESISTOR MUST BE FITTED TO THE LAST UNIT ON THE DSEnet

4.3.6 CONNECTIONS FOR DUAL MUTUAL STANDBY

DUAL MUTUAL STANDBY

NOTE: - This feature is available only on DSE7000 Series modules, V2.0.0 and above.

The output controls are *failsafe*. In the event of a module being out of service (battery removed) the output de-energises, giving the *ok to run* signal to the *other* set.

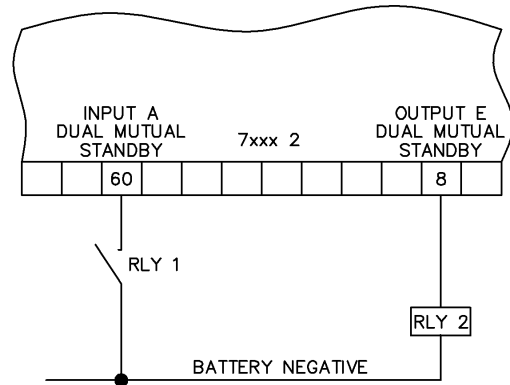
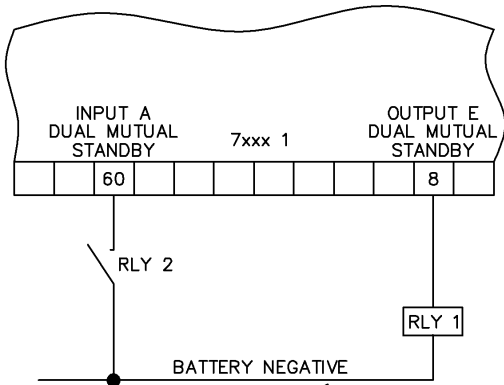

In case of set 1 failure, the output activates and energises the external relay RLY1 to call for the second set to start.

RLY1 contact closes a battery negative signal onto the input, instructing the set to start.

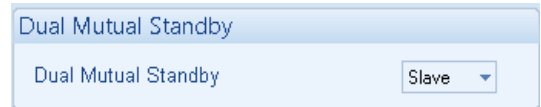

Screen capture from DSE Configuration Suite PC Software showing the configuration of the *Master* and *Slave* controllers.

4.3.7 EARTH SYSTEMS

4.3.7.1 NEGATIVE EARTH

The typical wiring diagrams located within this document are designed and show connections for a negative earth system (the battery negative is connected to Earth)

4.3.7.2 POSITIVE EARTH

When using a DSE module with a Positive Earth System (the battery positive is connected to Earth), the following points need to be followed :

- Follow the typical wiring diagram as normal for all sections EXCEPT the earthing points
- All points shown as Earth on the typical wiring diagram should connect to BATTERY NEGATIVE (not earth).

4.3.7.3 FLOATING EARTH

Where neither the battery positive nor battery negative terminals are connected to earth the following points need to be followed

- Follow the typical wiring diagram as normal for all sections EXCEPT the earthing points
- All points shown as Earth on the typical wiring diagram should connect to BATTERY NEGATIVE (not earth).

4.4 ALTERNATIVE TOPOLOGIES

The 7000 controller is factory configured to connect to a 3 phase, 4 wire Star connected alternator. This section details connections for alternative AC topologies. Ensure to configure the 7000 series controller to suit the required topology.

NOTE:- Further details of module configuration are contained within the DSE7000 Series configuration software manual (DSE part number 057-077)

4.4.1 3 PHASE, 4 WIRE WITHOUT EARTH FAULT PROTECTION

NOTE:- Mains sensing (Terminals 47-50) is not fitted to DSE7210/ DSE7310 autostart controllers.

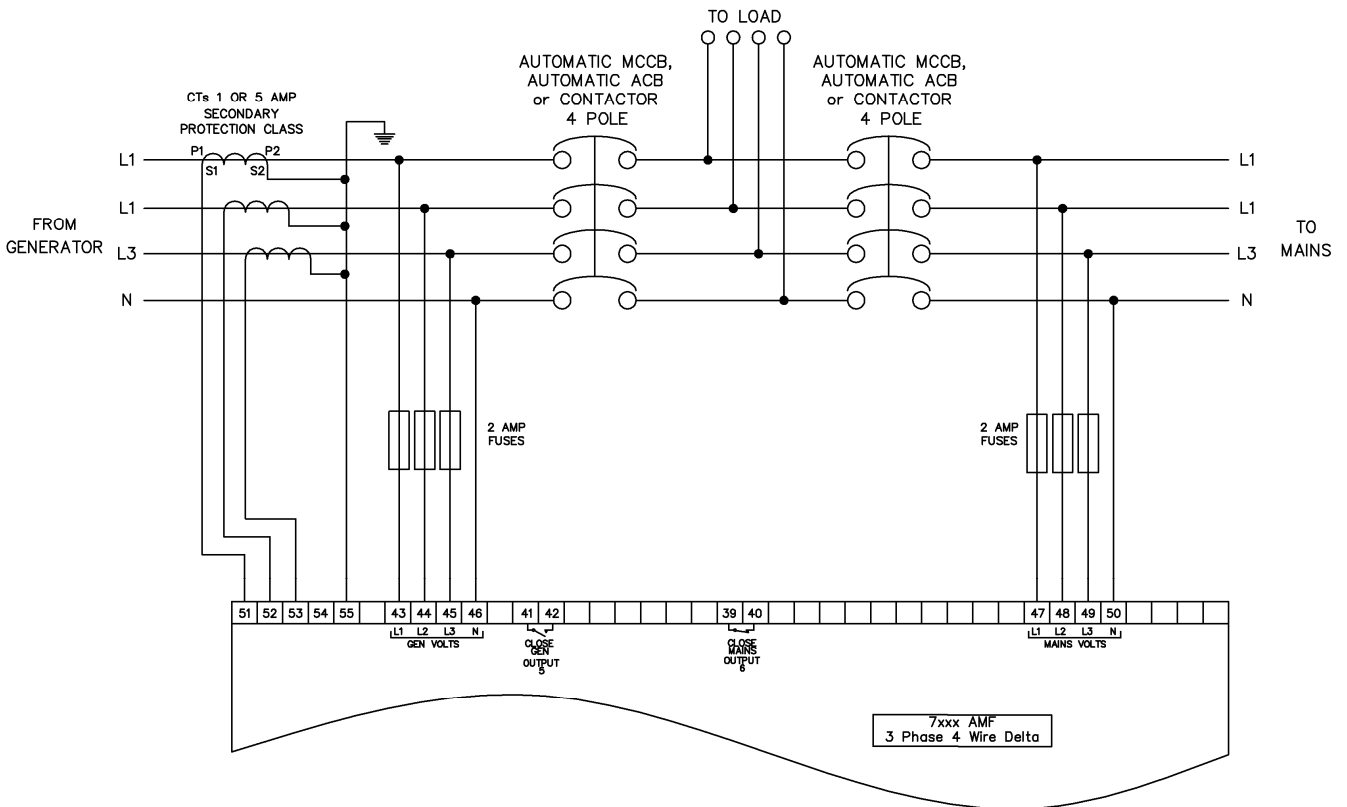

4.4.2 SINGLE PHASE WITH RESTRICTED EARTH FAULT

NOTE:- Earth fault measuring not available on 7200 series controllers.

NOTE:- Earth fault protection alarm only available on 7300 series V2.0 and above controllers. 7300 series V1.x.x modules have Earth fault measuring only (no protection alarms).

NOTE:- Mains sensing (Terminals 47-50) is not fitted to DSE7210/ DSE7310 autostart controllers.

NOTE:- Earthing the neutral conductor 'before' the neutral CT allows the module to read earth faults 'after' the CT only (Restricted to load / downstream of the CT)
 Earthing the neutral conductor 'after' the neutral CT allows the module to read earth faults 'before' the CT only (Restricted to generator / upstream of the CT)

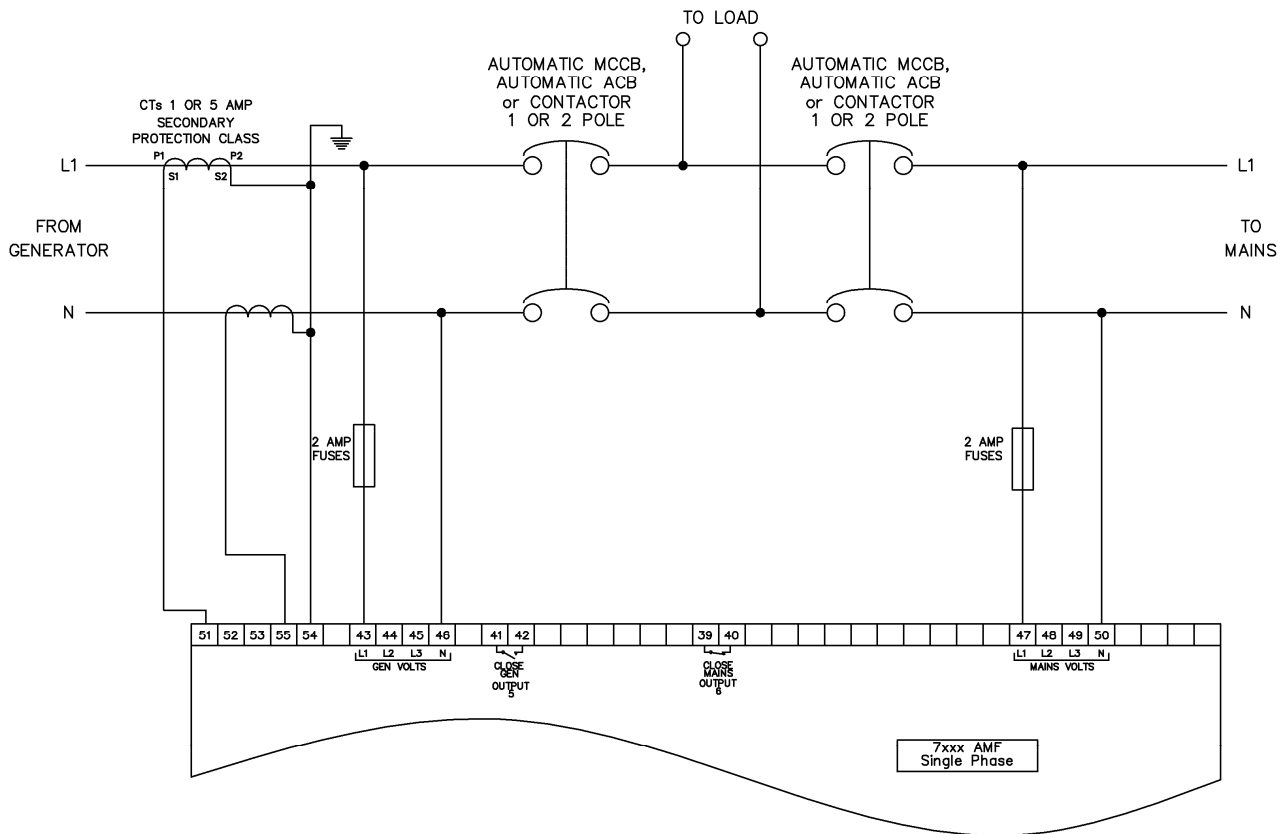

4.4.3 SINGLE PHASE WITHOUT EARTH FAULT

NOTE:- Mains sensing (Terminals 47-50) is not fitted to DSE7210/ DSE7310 autostart controllers.

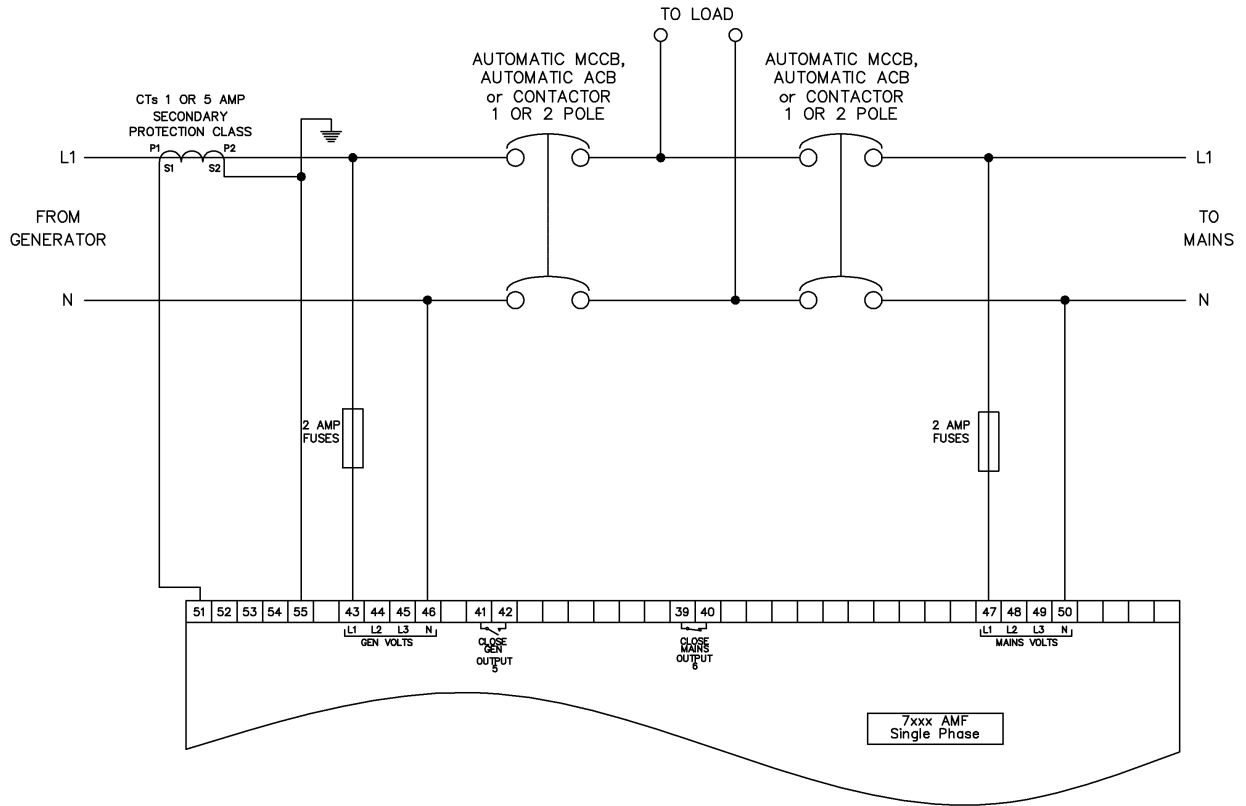

4.4.4 2 PHASE (L1 & L2) 3 WIRE WITH RESTRICTED EARTH FAULT

NOTE:- Earth fault protection alarm only available on 7300 series V2.0 and above controllers. 7300 series V1.x.x modules have Earth fault measuring only (no protection alarms).

NOTE:- Mains sensing (Terminals 47-50) is not fitted to DSE7210/ DSE7310 autostart controllers.

NOTE:- Earthing the neutral conductor 'before' the neutral CT allows the module to read earth faults 'after' the CT only (Restricted to load / downstream of the CT)
 Earthing the neutral conductor 'after' the neutral CT allows the module to read earth faults 'before' the CT only (Restricted to generator / upstream of the CT)

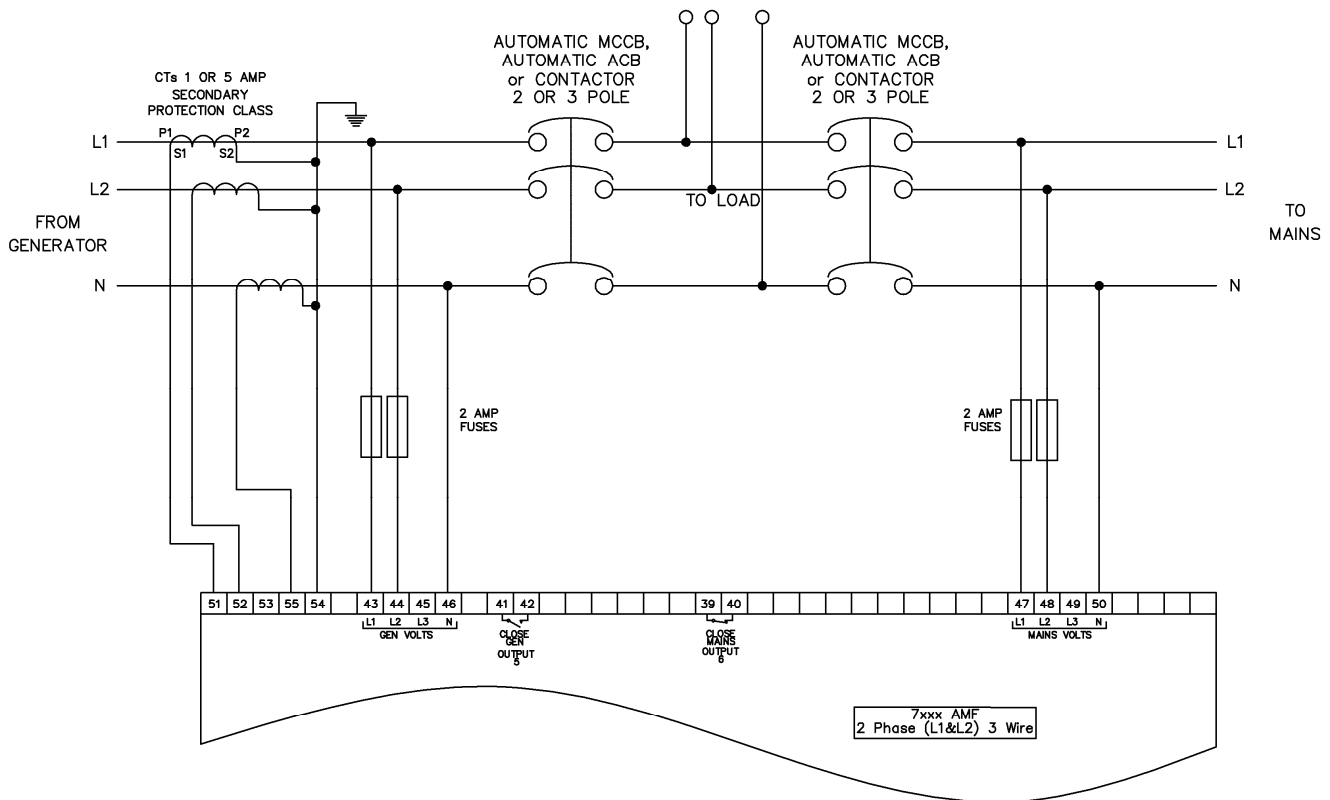

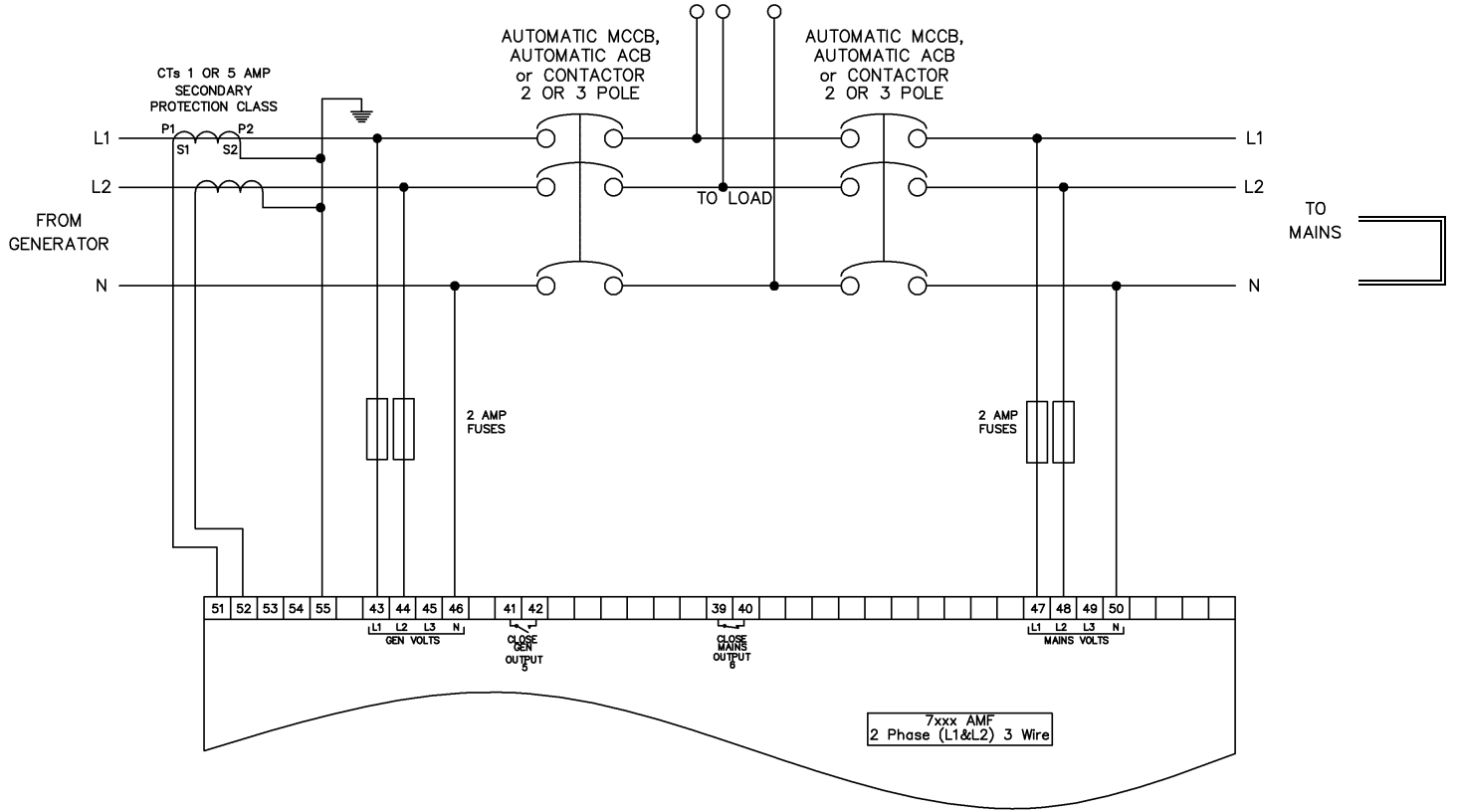

4.4.6 2 PHASE (L1 & L3) 3 WIRE WITH RESTRICTED EARTH FAULT

NOTE:- Earth fault protection alarm only available on 7300 series V2.0 and above controllers. 7300 series V1.x.x modules have Earth fault measuring only (no protection alarms).

NOTE:- Mains sensing (Terminals 47-50) is not fitted to DSE7210/ DSE7310 autostart controllers.

NOTE:- Earthing the neutral conductor 'before' the neutral CT allows the module to read earth faults 'after' the CT only (Restricted to load / downstream of the CT)
 Earthing the neutral conductor 'after' the neutral CT allows the module to read earth faults 'before' the CT only (Restricted to generator / upstream of the CT)

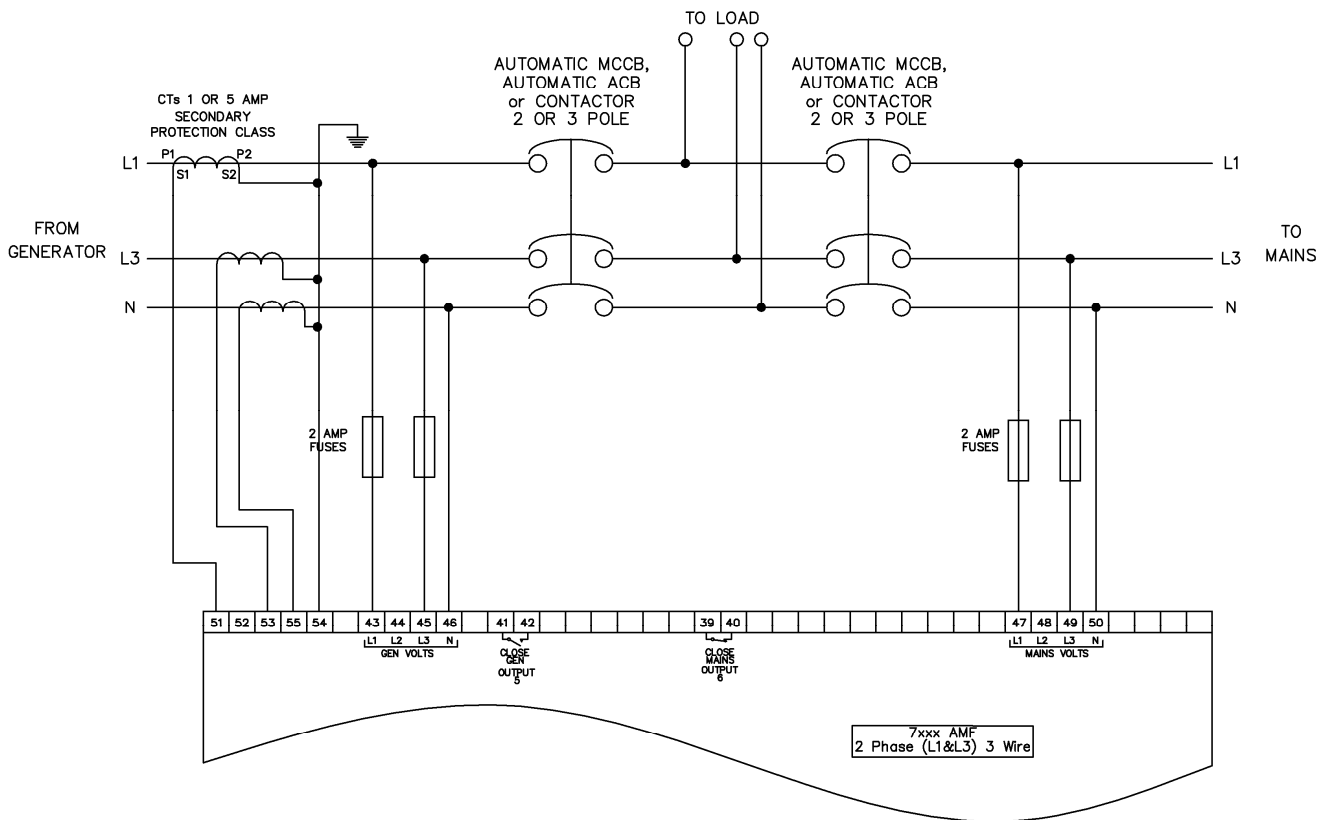

4.4.7 2 PHASE (L1 & L3) 3 WIRE WITHOUT EARTH FAULT MEASURING

NOTE:- Mains sensing (Terminals 47-50) is not fitted to DSE7210/ DSE7310 autostart controllers.

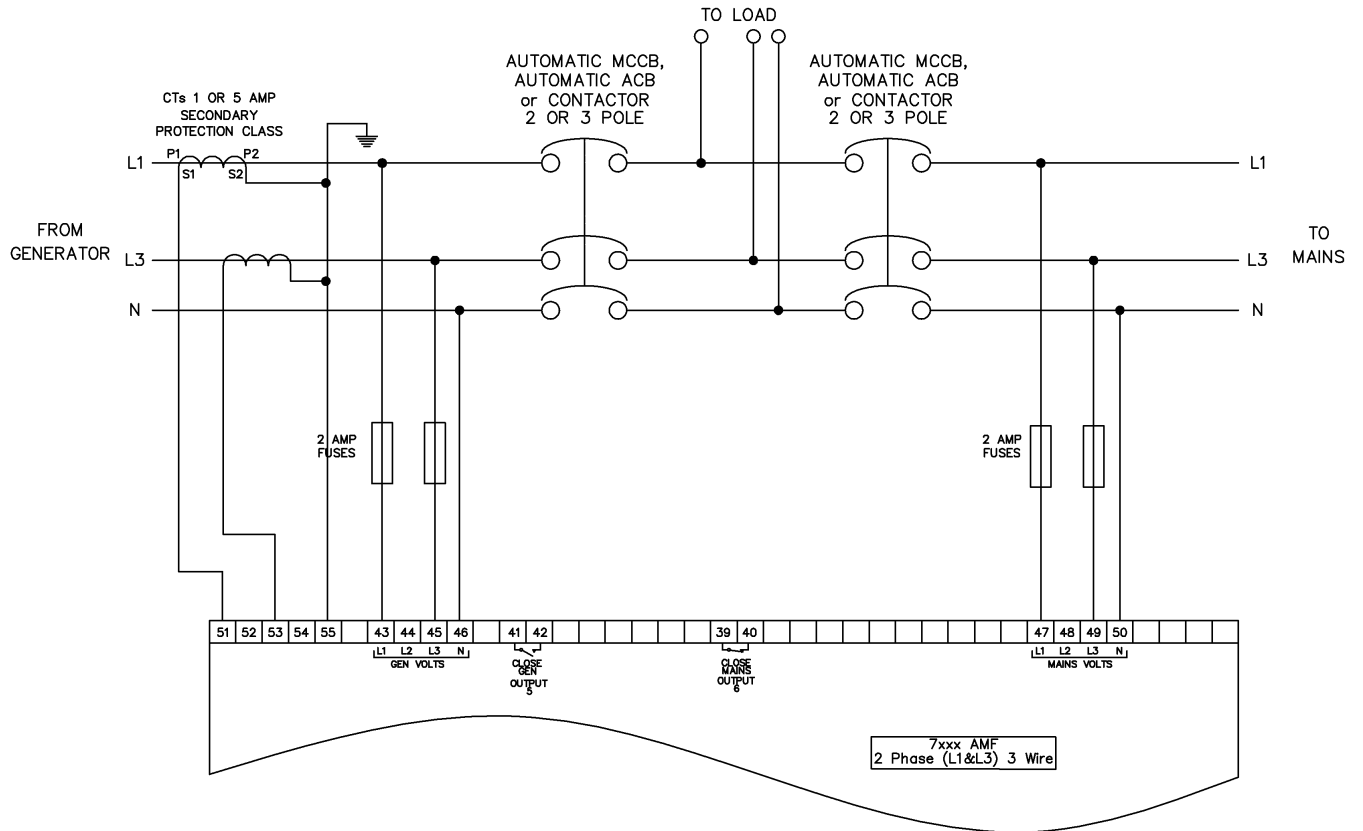

4.4.8 3 PHASE 4 WIRE WITH UNRESTRICTED EARTH FAULT MEASURING

NOTE:- Earth fault protection alarm only available on 7300 series V2.0 and above controllers. 7300 series V1.x.x modules have Earth fault measuring only (no protection alarms).

NOTE:- Mains sensing (Terminals 47-50) is not fitted to DSE7210/ DSE7310 autostart controllers.

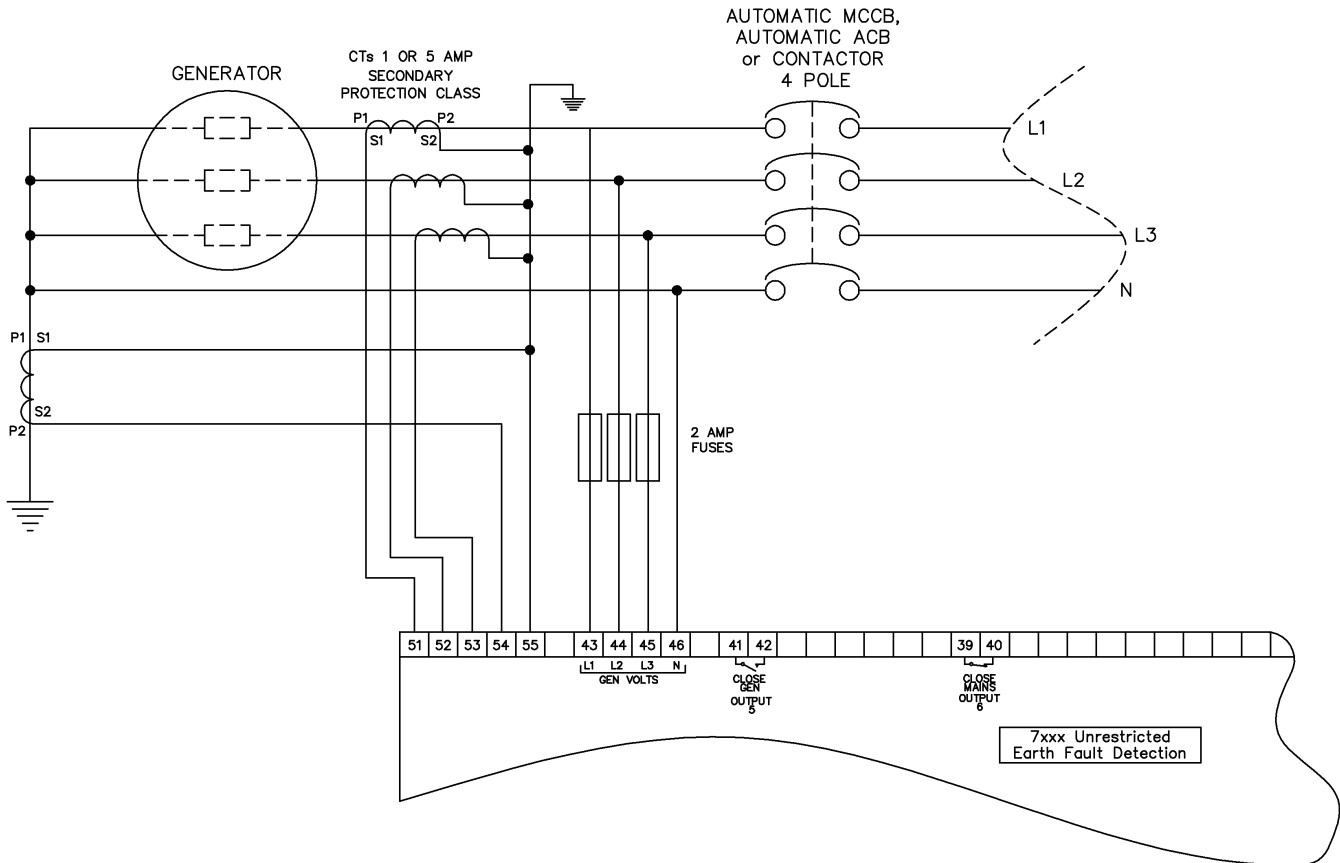

4.4.9 CT LOCATION

NOTE:- CT Location is not applicable to the DSE7210 / DSE7310 autostart controllers.

There are two possible locations for the current transformers in the system:

- 1) **Generator** : The CTs are used to measure and display generator current only. The typical wiring diagrams in the preceding section all show the CT measuring the generator load. For clarity, an example is shown below.

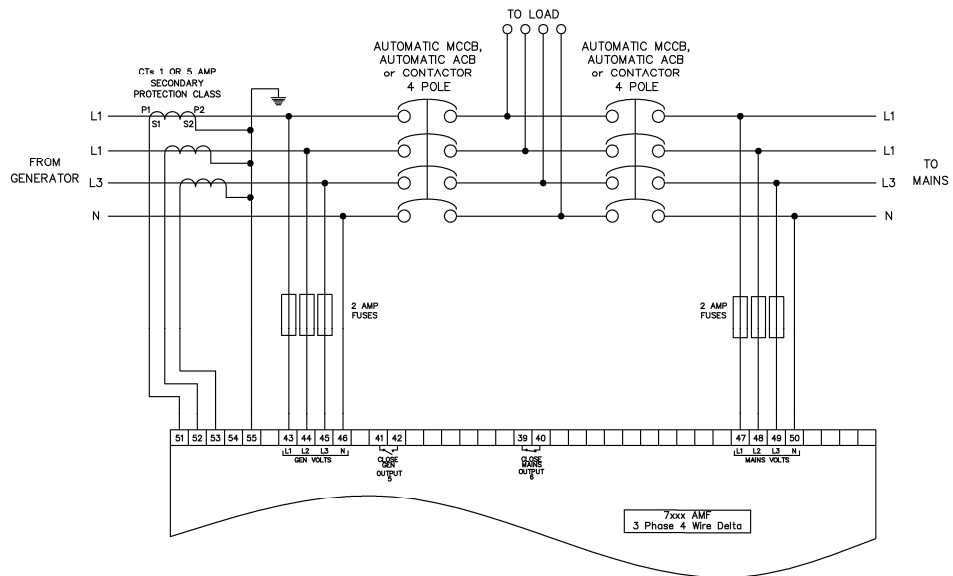

- 2) **Load** : The CTs are used to measure and display generator current when the generator is on load and mains current when the mains is on load. The module display automatically changes to display the current in the relevant instrumentation page. This example shows the CTs in the 'load' for a three phase delta system but the same philosophy is applicable to the other topologies.

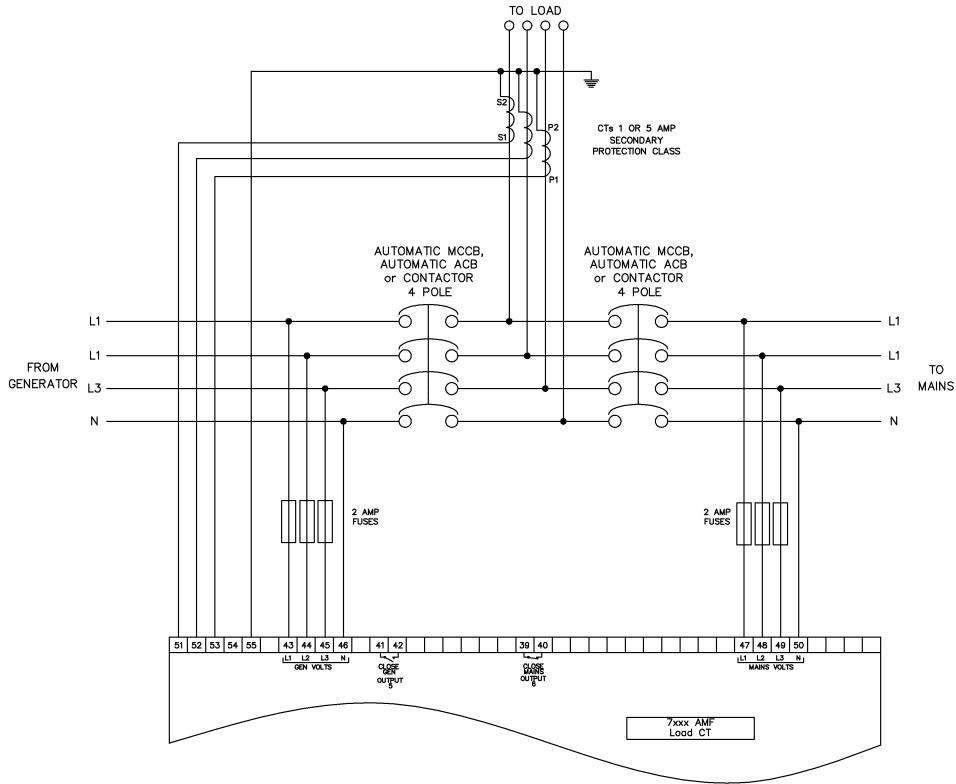

4.5 TYPICAL ARRANGEMENT OF DSENET®

A total of twenty (20) devices can be connected to the DSENet®, made up of the following devices :

| Device | Max number supported |
|-----------------------------|----------------------|
| DSE2130 Input Expansion | 4 |
| DSE2157 Output Expansion | 10 |
| DSE2548 LED Expansion | 10 |
| DSE2510 Display for DSE7310 | 3 |
| DSE2520 Display for DSE7320 | 3 |

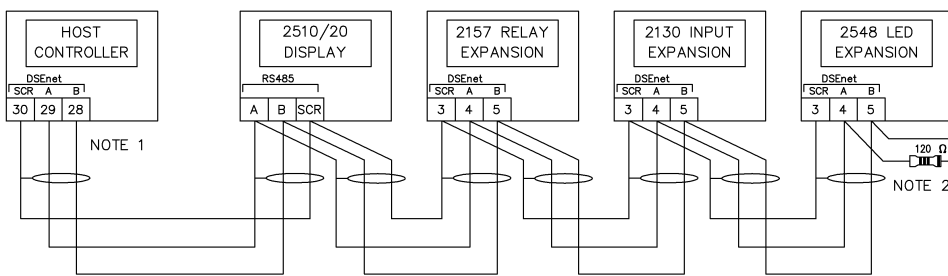

NOTE 1
AS A TERMINATING RESISTOR IS INTERNALLY FITTED TO THE HOST CONTROLLER, THE HOST CONTROLLER MUST BE THE FIRST UNIT ON THE DSEnet

NOTE 2
A 120 OHM TERMINATION RESISTOR MUST BE FITTED TO THE LAST UNIT ON THE DSEnet

5 DESCRIPTION OF CONTROLS

The following section details the function and meaning of the various controls on the module.

5.1 DSE7210 / DSE7310 AUTOSTART CONTROL MODULE

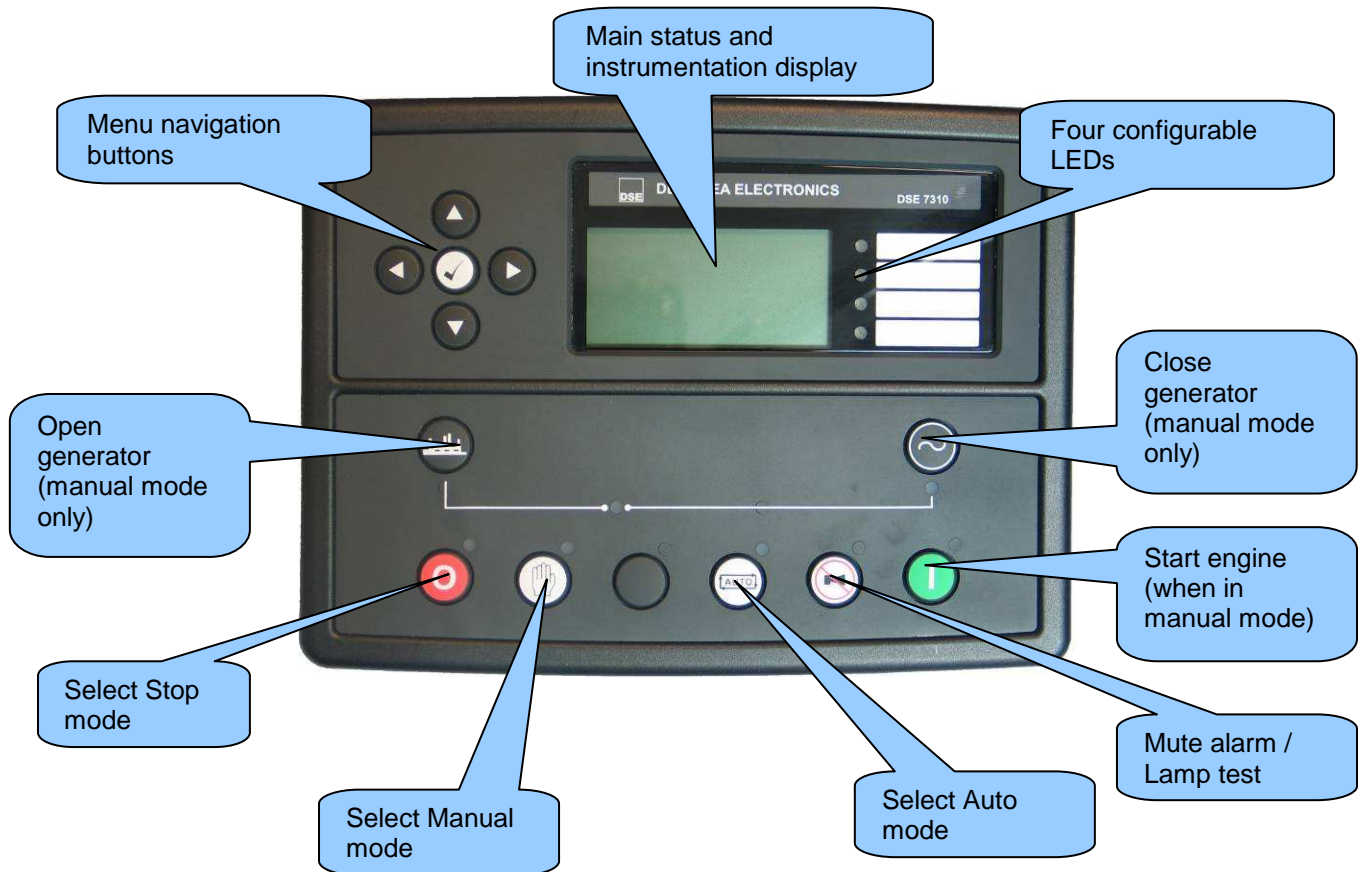

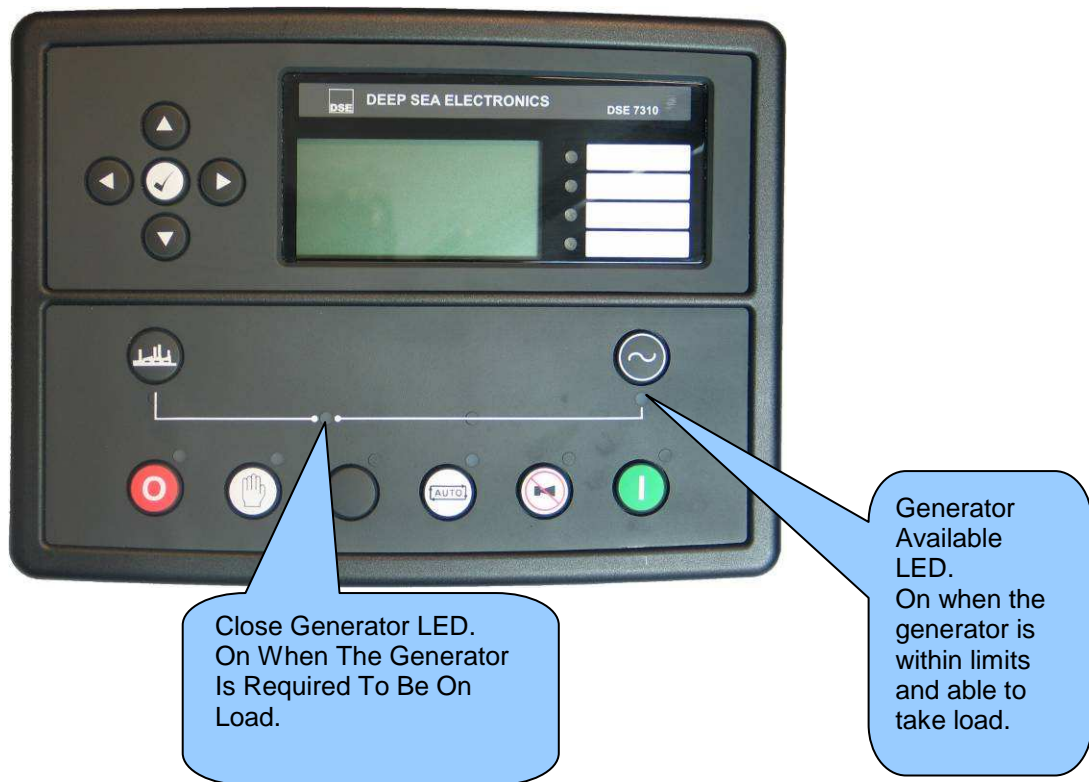

▲NOTE:- “Generator on load” LED has two modes of operation depending upon the configuration of the controllers digital inputs.

- 1) Digital input configured for “Generator closed auxiliary” – The LED illuminates when the generator closed auxiliary input is active – The LED shows the state of the auxiliary contact.
- 2) There is NO input configured for “Generator closed auxiliary” (factory default setting) – The LED illuminates when the 7x20 gives the loading signal to the generator – The LED shows the state of the 7x20’s loading request.

5.2 DSE7220 / DSE7320 AMF CONTROL MODULE

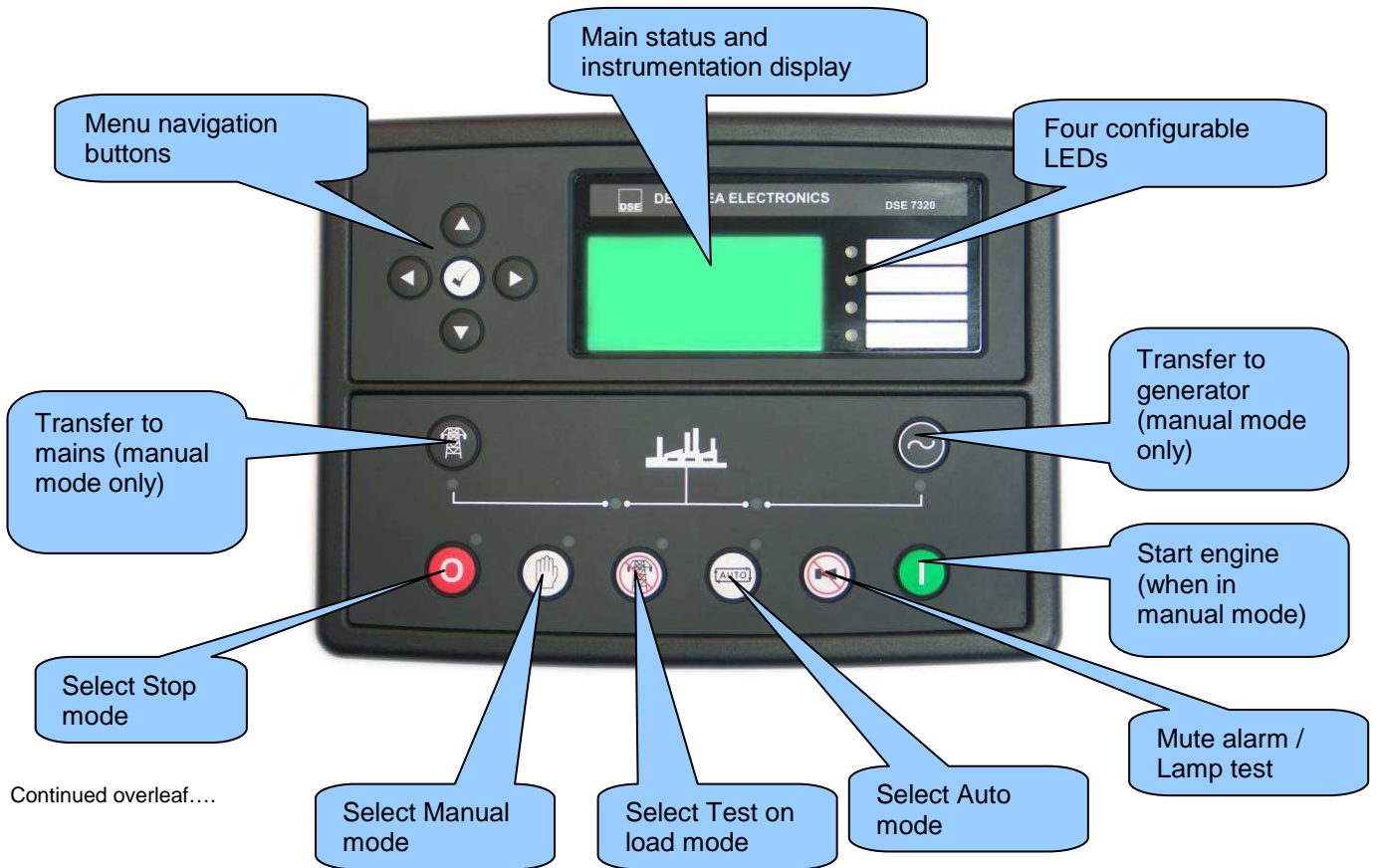

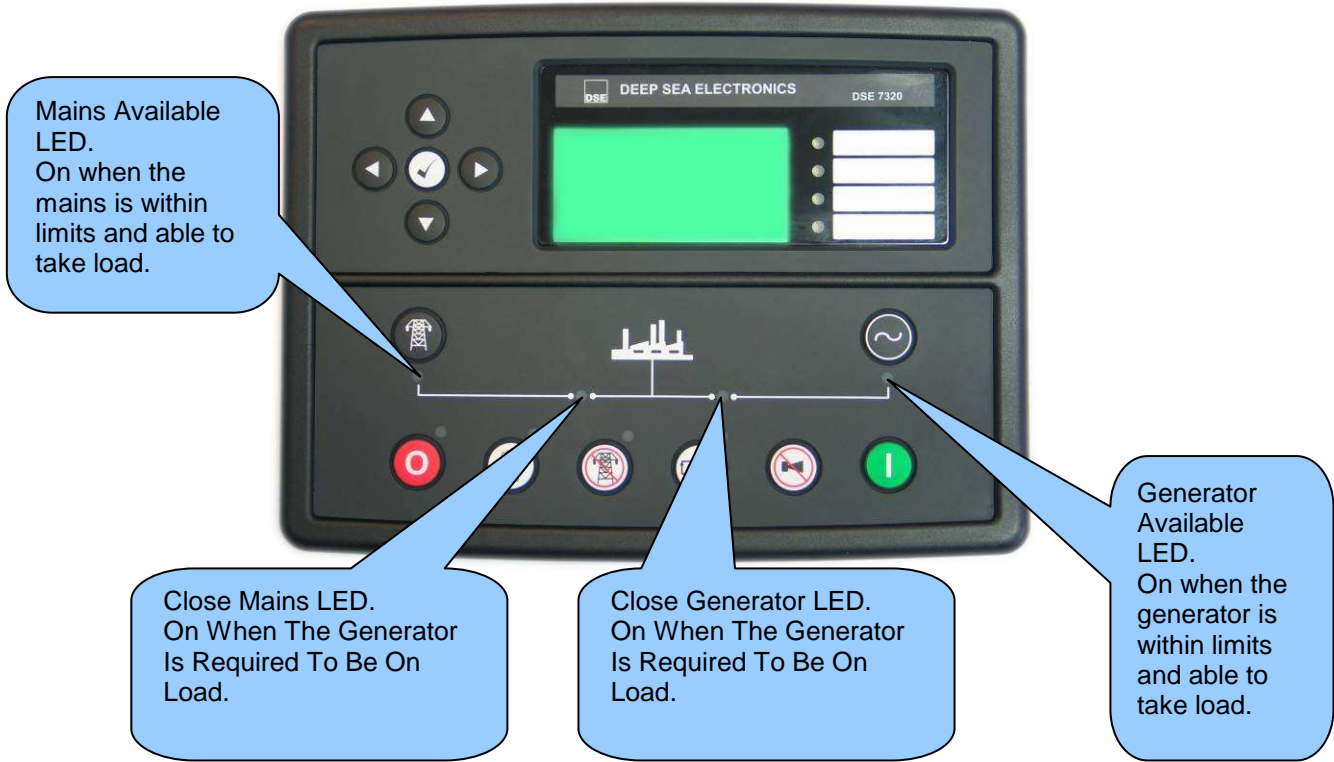

NOTE:- “Generator on load” LED has two modes of operation depending upon the configuration of the controllers digital inputs.

- 3) Digital input configured for “Generator closed auxiliary” – The LED illuminates when the generator closed auxiliary input is active – The LED shows the state of the auxiliary contact.
- 4) There is NO input configured for “Generator closed auxiliary” (factory default setting) – The LED illuminates when the 7x20 gives the loading signal to the generator – The LED shows the state of the 7x20’s loading request.

NOTE:- “Mains on load” LED has two modes of operation depending upon the configuration of the controllers digital inputs.

- 5) Digital input configured for “Mains closed auxiliary” – The LED illuminates when the mains closed auxiliary input is active – The LED shows the state of the auxiliary contact.
- 6) There is NO input configured for “Mains closed auxiliary” (factory default setting) – The LED illuminates when the 7x20 gives the loading signal to the mains – The LED shows the state of the 7x20’s loading request.

5.3 QUICKSTART GUIDE

This section provides a quick start guide to the module's operation.

5.3.1 STARTING THE ENGINE



NOTE:- For further details, see the section entitled 'OPERATION' elsewhere in this manual.

5.3.2 STOPPING THE ENGINE



NOTE:- For further details, see the section entitled 'OPERATION' elsewhere in this manual.

5.4 VIEWING THE INSTRUMENT PAGES

It is possible to scroll to display the different pages of information by repeatedly operating the next / previous page buttons.

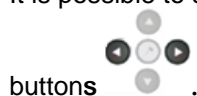

Example



If you want to view one of the instrument pages towards the end of the list, it may be quicker to scroll left through the pages rather than right!

And so on until the last page is reached. A Further press of the scroll right button, returns the display to the Status page.

The complete order and contents of each information page are given in the following sections

Once selected the page will remain on the LCD display until the user selects a different page, or after an extended period of inactivity (*LCD Page Timer*), the module will revert to the status display.

If no buttons are pressed upon entering an instrumentation page, the instruments will be displayed automatically subject to the setting of the *LCD Scroll Timer*.

The *LCD Page* and *LCD Scroll* timers are configurable using the DSE Configuration Suite Software or by using the Front Panel Editor.

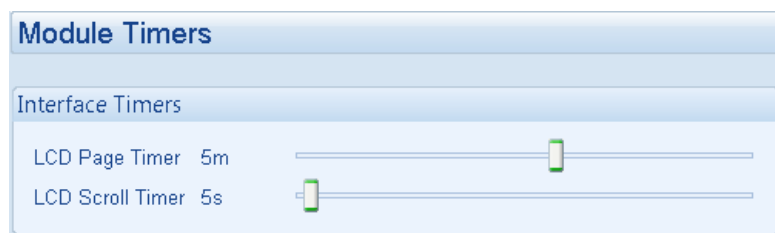

The screenshot shows the factory settings for the timers, taken from the DSE Configuration Suite Software.

Alternatively, to scroll manually through all instruments on the currently selected page, press the scroll buttons. The 'autoscroll' is disabled.



If you want to view one of the instruments towards the end of the list, it may be quicker to scroll up through the instruments rather than down!

To re-enable 'autoscroll' press the scroll buttons to scroll to the 'title' of the instrumentation page (ie Engine). A short time later (the duration of the *LCD Scroll Timer*) the instrumentation display will begin to autoscroll.

When scrolling manually, the display will automatically return to the Status page if no buttons are pressed for the duration of the configurable *LCD Page Timer*.

If an alarm becomes active while viewing the status page, the display shows the Alarms page to draw the operator's attention to the alarm condition.

5.4.1 STATUS

This is the 'home' page, the page that is displayed when no other page has been selected, and the page that is automatically displayed after a period of inactivity (*LCD Page Timer*) of the module control buttons.

This page is configurable using the DSE Configuration Suite Software.

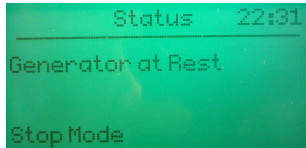

Factory setting of Status screen showing engine stopped...



...and engine running

The contents of this display may vary depending upon configuration by the generator manufacturer / supplier.

The display above was achieved with the factory settings, shown below in the DSE Configuration suite software:

The screenshot shows the 'Configurable Status Screens' interface. It has a 'Home Page' section with a dropdown menu set to 'Mode'. Below is a 'Displayed Pages' section with a table of 10 pages. Callouts explain that 'Stop Mode' is shown on the Home Page, Page 1 is a summary screen, and other pages can be configured for automatic scrolling.

| Page | Configuration | Page | Configuration |
|--------|----------------|---------|---------------|
| Page 1 | Summary screen | Page 6 | Not Used |
| Page 2 | Not Used | Page 7 | Not Used |
| Page 3 | Not Used | Page 8 | Not Used |
| Page 4 | Not Used | Page 9 | Not Used |
| Page 5 | Not Used | Page 10 | Not Used |

NOTE:- The following sections detail instrumentation pages, accessible using the scroll left and right buttons, regardless of what pages are configured to be displayed on the 'status' screen.

5.4.2 ENGINE

Contains instrumentation gathered about the engine itself, some of which may be obtained using the CAN or other electronic engine link.

- Engine Speed
- Oil Pressure
- Coolant Temperature
- Engine Battery Volts
- Run Time
- Oil Temperature*
- Coolant Pressure*
- Inlet Temperature*
- Exhaust Temperature*
- Fuel Temperature*
- Turbo Pressure
- Fuel Pressure*
- Fuel Consumption*
- Fuel Used*
- Fuel Level*
- Auxiliary Sensors (If fitted and configured)
- Engine Maintenance Due (If configured)
- Engine ECU Link*

*When connected to suitably configured and compatible engine ECU. For details of supported engines see 'Electronic Engines and DSE wiring' (DSE Part number 057-004).

Depending upon configuration and instrument function, some of the instrumentation items may include a tick  icon beside them. This denotes a further function is available, detailed in the 'operation' section of this document.

Example:

The tick  icon denotes that manual fuel pump control is enabled in this system. Press and hold to start the fuel transfer pump, release to stop the pump. This is further detailed in the section entitled 'operation' elsewhere in this document.

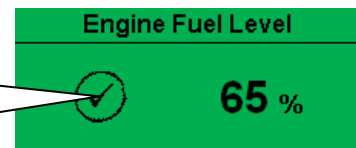

5.4.3 GENERATOR

Contains electrical values of the generator (alternator), measured or derived from the module's voltage and current inputs.

- Generator Voltage (ph-N)
- Generator Voltage (ph-ph)
- Generator Frequency
- Generator Current
- Generator Earth Current
- Generator Load (kW)
- Generator Load (kVA)
- Generator Power Factor
- Generator Load (kVA_r)
- Generator Load (kWh, kVAh, kVA_rh)
- Generator Phase Sequence
- Dual Mutual Status

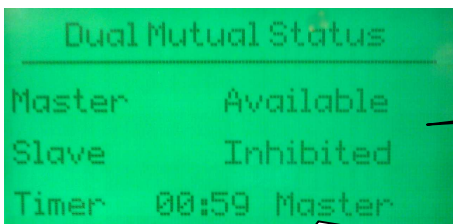

Available : The set is running and available
Inhibited : The set is prevented from running by the 'other' controller

Master : The master set will call for the slave when the timer (hrs:mins) expires.
Slave : The master will call for the slave until the timer (hrs:mins) expires.

5.4.4 MAINS (DSE7220/DSE7320 ONLY)

Contains electrical values of the mains (utility) supply, measured or derived from the module's mains voltage and current (where applicable) inputs.

- Mains Voltage (ph-N)
- Mains Voltage (ph-ph)
- Mains Current (if the CT location is in the 'load' and the mains is 'on load')
- Mains Frequency

5.4.5 SERIAL PORT

This section is included to give information about the currently selected serial port and external modem (if connected).

The items displayed on this page will change depending upon configuration of the module. You are referred to your system supplier for further details.

NOTE:- Factory Default settings are for the RS232 port to be enabled (no modem connected), operating at 19200 baud, modbus slave address 10.

Example 1 – Module connected to a RS232 telephone modem.

When the DSE7300 series module is power up, it will send 'initialisation strings' to the connected modem. It is important therefore that the modem is already powered, or is powered up at the same time as the DSE7300 series module. At regular intervals after powerup, the modem is reset, and reinitialised, to ensure the modem does not 'hang up'.

If the DSE7300 series module does not correctly communicate with the modem, "Modem initialising" will appear on the Serial Port instrument screen as shown overleaf.

If the module is set for "incoming calls" or for "incoming and outgoing calls", then if the modem is dialled, it will answer after two rings (using the factory setting 'initialisation strings'. Once the call is established, all data is passed from the dialling PC and the DSE7300 series module.

If the module is set for "outgoing calls" or for "incoming and outgoing calls", then the module will dial out whenever an alarm is generated. Note that not all alarms will generate a dial out, this is dependant upon module configuration of the event log. Any item configured to appear in the event log will cause a dialout.

| Serial Port | |
|-------------|------|
| Baud | 9600 |
| SlaveID | 10 |
| Modem | |

Press down  to view the modem status....

Indicates that a modem is configured. Shows 'RS232' if no modem is configured or 'RS485' if the RS485 port is selected.

Example 1 continued – Modem diagnostics

NOTE:- Modem diagnostic screens are available on 73xx module versions 5 and above only. The modem screens appear only when the module has been configured for use with a modem.



Modem diagnostic screens are included; press  when viewing the *Serial Port* instrument to cycle the available screens. If you are experiencing modem communication problems, this information will aid troubleshooting.

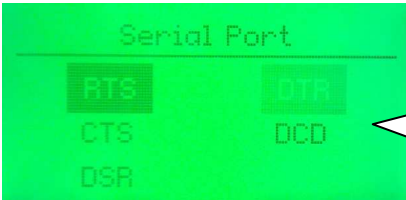

Shows the state of the modem communication lines. These can help diagnose connection problems.

Example :

- RTS** A dark background shows the line is active.
- RTS** a grey background shows that the line is toggling high and low.
- RTS** No background indicates that the line is inactive

| Line | Description | |
|------|---------------------|----------------------|
| RTS | Request To Send | Flow control |
| CTS | Clear To Send | Flow control |
| DSR | Data Set Ready | Ready to communicate |
| DTR | Data Terminal Ready | Ready to communicate |
| DCD | Data Carrier Detect | Modem is connected |



Shows the last command sent to the modem and the result of the command.

Modem Setup Sequence

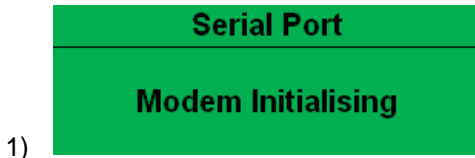

If the Modem and DSE7000 series communicate successfully:

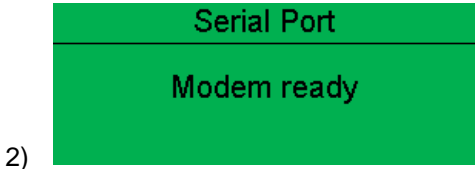

In case of communication failure between the modem and DSE7000 series module, the modem is automatically reset and initialisation is attempted once more:

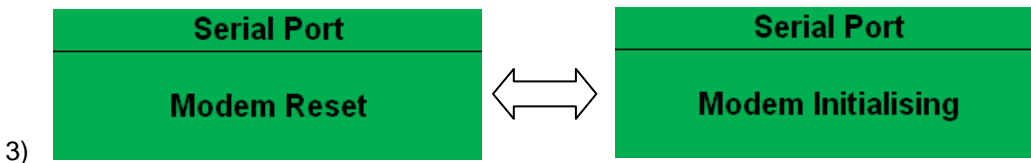

In the case of a module that is unable to communicate with the modem, the display will continuously cycle between 'Modem Reset' and 'Modem Initialising' as the module resets the modem and attempts to communicate with it again, this will continue until correct communication is established with the modem. In this instance, you should check connections and verify the modem operation.

Example 2 – Module connected to a modem.

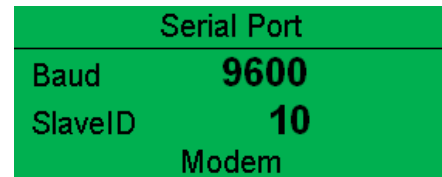

Example 3 – Modem status of a GSM modem

Currently connected GSM operator and signal strength.

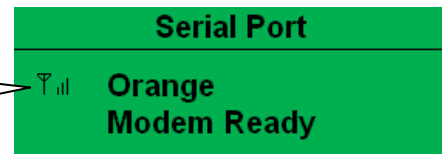

Many GSM modems are fitted with a status LED to show operator cell status and ringing indicator. These can be a useful troubleshooting tool.

In the case of GSM connection problems, try calling the DATA number of the SIMCARD with an ordinary telephone. There should be two rings, followed by the modem answering the call and then 'squealing'. If this does not happen, you should check all modem connections and double check with the SIM provider that it is a DATA SIM and can operate as a data modem. DATA is NOT the same as FAX or GPRS and is often called Circuit Switched Data (CSD) by the SIM provider.

NOTE: In the case of GSM modems, it is important that a DATA ENABLED SIM is used. This is often a different number than the 'voice number' and is often called Circuit Switched Data (CSD) by the SIM provider.

If the GSM modem is not purchased from DSE, ensure that it has been correctly set to operate at 9600 baud. You may need to install a terminal program on your PC and consult your modem supplier to do this. GSM modems purchased from DSE are already configured to work with the DSE7300 series module.

Example 4 - Module RS485 port configured for connection to a modbus master.

| Serial Port | |
|-------------|-------|
| Baud | 19200 |
| SlaveID | 1 |
| RS485 | |

DSE7300 series modules operate as a modbus RTU slave device.

In a modbus system there can be only one Master, typically a PLC, HMI system or PC SCADA system.

This master requests for information from the modbus slave (DSE7300 series module) and may (in control systems) also send request to change operating modes etc. Unless the Master makes a request, the slave is 'quiet' on the datalink.

The factory settings are for the module to communicate at 19200 baud, modbus slave address 10.

To use the RS485 port, ensure that 'port usage' is correctly set using the DSE Configuration Suite Software.

Required settings are shown below.

The screenshot shows the 'Serial Port Configuration' window with the following settings: Slave ID is 10, Baud Rate is 19200, and Port Usage is RS485. Below this is the 'Connection Settings' window, which shows the Master inactivity timeout set to 5s.

'Master inactivity timeout' should be set to at least twice the value of the system scan time. For example if a modbus master PLC requests data from the DSE7300 modbus slave once per second, the timeout should be set to at least 2 seconds.

The DSE Modbus Gencomm document containing register mappings inside the DSE module is available upon request from support@deepseapl.com. Email your request along with the serial number of your DSE module to ensure the correct information is sent to you.

Typical requests (using Pseudo code)

BatteryVoltage=ReadRegister(10,0405,1) : reads register (hex) 0405 as a single register (battery volts) from slave address 10.

WriteRegister(10,1008,2,35701, 65535-35701) : Puts the module into AUTO mode by writing to (hex) register 1008, the values 35701 (auto mode) and register 1009 the value 65535-35701 (the bitwise opposite of auto mode)

Shutdown=(ReadRegister(10,0306,1) >> 12) & 1) : reads (hex) 0306 and looks at bit 13 (shutdown alarm present)

Warning=(ReadRegister(10,0306,1) >> 11) & 1) : reads (hex) 0306 and looks at bit 12 (Warning alarm present)

ElectricalTrip=(ReadRegister(10,0306,1) >> 10) & 1) : reads (hex) 0306 and looks at bit 11 (Electrical Trip alarm present)

ControlMode=ReadRegister(10,0304,2); reads (hex) register 0304 (control mode).

5.4.6 ABOUT

Contains important information about the module and the firmware versions. This information may be asked for when contacting DSE Technical Support Department for advice.

| About | |
|-------------|--------|
| Variant | 7320 |
| Application | V8.0.7 |
| USB ID | BC614E |

- Variant (ie 7210, 7220, 7310, 7320)
- Application Version – The version of the module’s main firmware file (Updatable using the Firmware Update Wizard in the DSE Configuration Suite Software).
- USB ID – Unique identifier for PC USB connection



Press  to access more information about the module.

| About | |
|------------|--------|
| Bootloader | V1.3.4 |
| Analogue | V2.0.0 |

- Bootloader - Firmware Update bootloader software version
- Analogue – Analogue measurements software version



Press  to access more information about the module.

| About | |
|-------------|-------------|
| Engine Type | Volvo EMS2b |
| Version | V1.18 |

- Engine Type – The type of engine or ECU file which is configured within the module.
- Version – Engine type file version.

5.4.7 CAN ERROR MESSAGES

When connected to a suitable CAN engine the 7000 series controller displays alarm status messages from the ECU.

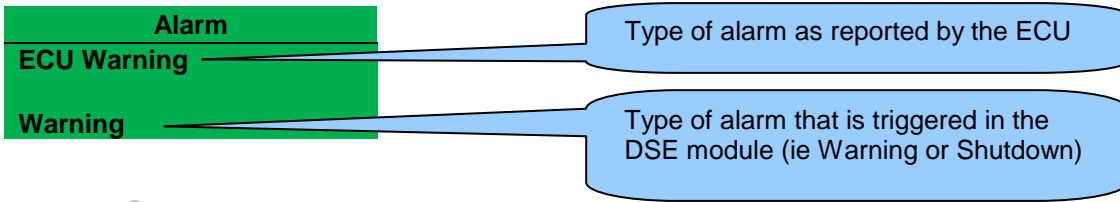

Press  to access the list of current active Engine DTCs (Diagnostic Trouble Codes).

| | |
|--------------------|--|
| Engine DTCs | The code interpreted by the module shows on the display as a text message. Additionally, the manufacturer's code is shown. |
| Water Level | |
| Low Xxx,xxx,xxx | |

▲ NOTE:- For details on these code meanings, refer to the ECU instructions provided by the engine manufacturer, or contact the engine manufacturer for further assistance.

▲ NOTE:- For further details on connection to electronic engines please refer to *Electronic engines and DSE wiring*. Part No. 057-004

5.5 VIEWING THE EVENT LOG

The DSE7000 series modules maintain a log of past alarms and/or selected status changes. The log size has been increased in the module over past module updates and is always subject to change. At the time of writing, the 7300 series log is capable of storing the last 250 log entries.

Under default factory settings, the event log only includes shutdown and electrical trip alarms logged (The event log does not contain Warning alarms), however this is configurable by the system designer using the DSE Configuration Suite software.

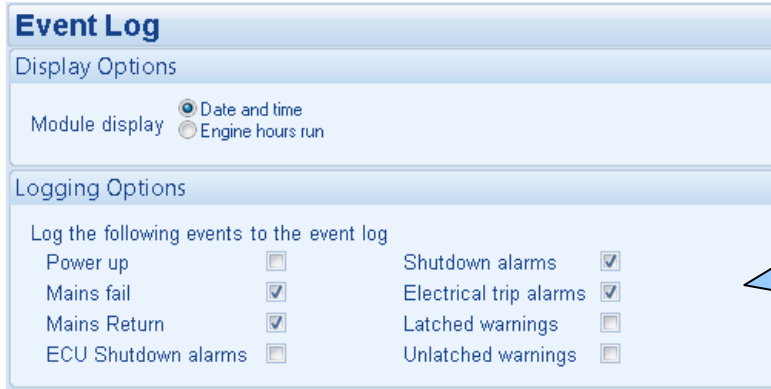

Example showing the possible configuration of the DSE7000 series event log (DSE Configuration Suite Software)
This also shows the factory settings of the module (Only shutdown alarms and the mains status are logged).

Once the log is full, any subsequent shutdown alarms will overwrite the oldest entry in the log. Hence, the log will always contain the most recent shutdown alarms. The module logs the alarm, along with the date and time of the event (or engine running hours if configured to do so).

If the module is configured and connected to send SMS text



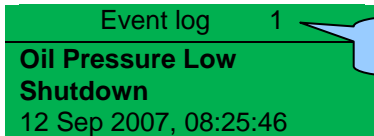

To view the event log, repeatedly press the next page button until the LCD screen displays the Event log :



This is event 1.

Press down  to view the next most recent shutdown alarm:

Continuing to press down  cycles through the past alarms after which the display shows the most recent alarm and the cycle begins again.

To exit the event log and return to viewing the instruments, press the next page  button to select the next instrumentation page.

5.6 USER CONFIGURABLE INDICATORS











These LEDs can be configured by the user to indicate any one of **100+ different functions** based around the following:-





- **Indications** - Monitoring of a digital input and indicating associated functioning user's equipment - *Such as Battery Charger On or Louver's Open, etc.*
- **WARNINGS and SHUTDOWNS** - Specific indication of a particular warning or shutdown condition, backed up by LCD indication - *Such as Low Oil Pressure Shutdown, Low Coolant level, etc.*
- **Status Indications** - Indication of specific functions or sequences derived from the modules operating state - *Such as Safety On, Pre-heating, Panel Locked, Generator Available, etc.*



User configurable LEDs

5.7 CONTROLS

| | |
|--|---|
| <p>Stop / Reset</p> <p>This button places the module into its Stop/Reset mode. This will clear any alarm conditions for which the triggering criteria have been removed. If the engine is running and the module is in Stop mode, the module will automatically instruct the changeover device to unload the generator ('Close Generator' becomes inactive (if used)). The fuel supply de-energises and the engine comes to a standstill. Should a remote start signal be present while operating in this mode, a remote start will <u>not</u> occur.</p> |  |
| <p>Manual</p> <p>This mode allows manual control of the generator functions. Once in Manual mode the module will respond to the start  button, start the engine, and run off load. If the engine is running off-load in the Manual mode and a remote start signal becomes present, the module will automatically instruct the changeover device to place the generator on load ('Close Generator' becomes active (if used)). Upon removal of the remote start signal, the generator remains on load until either selection of the 'STOP/RESET' or 'AUTO' modes.</p> <p><i>For further details, please see the more detailed description of 'Manual operation' elsewhere in this manual.</i></p> |  |
| <p>Auto</p> <p>This button places the module into its 'Automatic' mode. This mode allows the module to control the function of the generator automatically. The module will monitor the <i>remote start</i> input and mains supply status and once a start request is made, the set will be automatically started and placed on load.</p> <p>Upon removal of the starting signal, the module will automatically transfer the load from the generator and shut the set down observing the <i>stop delay</i> timer and <i>cooling</i> timer as necessary. The module will then await the next start event. <i>For further details, please see the more detailed description of 'Auto operation' elsewhere in this manual.</i></p> |  |
| <p>5.7.1.1 TEST (DSE7220/DSE7320 ONLY)</p> <p>This button places the module into its 'Test' mode. This allows an on load test of the generator.</p> <p>Once in Test mode the module will respond to the start  button, start the engine, and run on load.</p> <p><i>For further details, please see the more detailed description of 'Test operation' elsewhere in this manual.</i></p> |  |
| <p>5.7.1.2 START</p> <p>This button is only active in STOP/RESET  or MANUAL  mode.</p> <p>Pressing this button in manual or test mode will start the engine and run off load (manual) or on load (test).</p> <p>Pressing this button in STOP/RESET mode will turn on the CAN engine ECU (when correctly configured and fitted to a compatible engine ECU)</p> |  |
| <p>Mute / Lamp Test</p> <p>This button silences the audible alarm if it is sounding and illuminates all of the LEDs as a lamp test feature/</p> <p>When correctly configured and fitted to a compatible engine ECU, pressing this button in STOP/RESET mode after pressing the START  button (to power the ECU) will cancel any "passive" alarms on the engine ECU.</p> |  |

| | |
|--|--|
| <p>Transfer to generator Operative in Manual Mode only</p> <p>‘Normal’ breaker button control</p> <ul style="list-style-type: none"> • Allows the operator to transfer the load to the generator <p>‘Alternative’ breaker button control (7320 V6+ only)</p> <ul style="list-style-type: none"> • If mains is on load, transfers the load to the generator. • If generator is on load, opens the generator breaker • If generator and mains are off load, closes the generator breaker. |  |
| <p>Open generator (DSE7210/DSE7310 only)</p> <p>Allows the operator to open the generator (when in Manual mode only)</p> |  |
| <p>Transfer to mains Operative in Manual Mode only</p> <p>‘Normal’ breaker button control</p> <ul style="list-style-type: none"> • Allows the operator to transfer the load to the mains <p>‘Alternative’ breaker button control (7320 V6+ only)</p> <ul style="list-style-type: none"> • If generator is on load, transfers the load to the mains. • If mains is on load, opens the mains breaker • If generator and mains are off load, closes the mains breaker. |  |
| <p>Menu navigation</p> <p>Used for navigating the instrumentation, event log and configuration screens. For further details, please see the more detailed description of these items elsewhere in this manual.</p> |  |

6 OPERATION (STANDALONE)

The following description details the sequences followed by a module containing the standard 'factory configuration'.

Remember that if you have purchased a completed generator set or control panel from your supplier, the module's configuration will probably have been changed by them to suit their particular requirements.

Always refer to your configuration source for the exact sequences and timers observed by any particular module in the field.



6.1 ALTERNATIVE CONFIGURATIONS

Depending upon the configuration of your system by the generator supplier, the system may have selectable configurations (for example to select between 50Hz and 60Hz running). If this has been enabled your generator supplier will advise how this selection can be made (usually by externally operated selector switch or by selecting the required configuration file in the DSE7000 series front panel configuration editor).

6.2 DUMMY LOAD / LOAD SHEDDING CONTROL

NOTE:- Dummy Load / Load Shedding Control is only available on DSE7300 series controllers V4 or above. This feature is not available on DSE7200 series.

This feature may be enabled by the system designer to ensure the loading on the generator is kept to a nominal amount. If the load is low, 'dummy loads' (typically static load banks) can be introduced to ensure the engine is not too lightly loaded. Conversely as the load increases towards the maximum rating of the set, non-essential loads can be shed to prevent overload of the generator.

6.2.1 DUMMY LOAD CONTROL

The *dummy load control* feature (if enabled) allows for a maximum of five dummy load steps. When the set is first started, all configured *Dummy Load Control* outputs are de-energised. Once the generator is placed onto load, the generator loading is monitored by the *Dummy Load Control* scheme.

If the generator loading falls below the *Dummy Load Control Trip* setting (kW), the *Dummy Load Control Trip Delay* is displayed on the module display. If the generator loading remains at this low level for the duration of the timer, the first *Dummy Load Control* output is energised. This is used to energise external circuits to switch in (for instance) a static load bank.

The generator loading has now been increased by the first dummy load. Again the generator loading is monitored. This continues until all configured *Dummy Load Control* outputs are energised.

Should the generator loading rise above the *Dummy Load Return* level, the *Dummy Load Return Delay* begins. If the loading remains at these levels after the completion of the timer, the 'highest' active *Dummy Load Control* output is de-energised. This continues until all *Dummy Load Control* outputs have been de-energised.

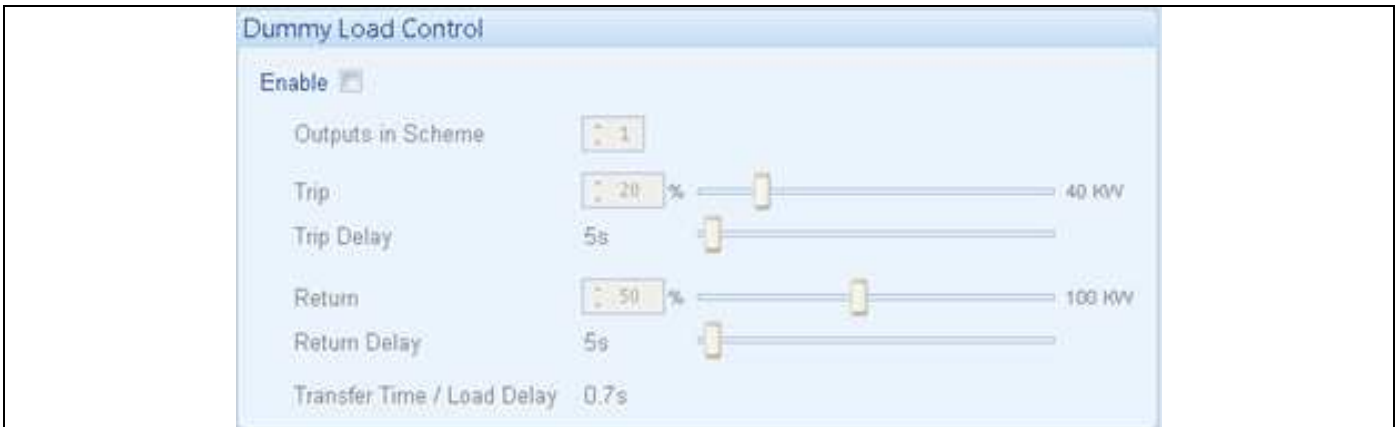

Example screen shot of *Dummy Load Control* setup in the DSE Configuration Suite

6.2.2 LOAD SHEDDING CONTROL

The *Load Shedding Control* feature (if enabled) allows for a maximum of five load shedding steps.

When the generator is about to take load, the configured number of *Load Shedding Control Outputs at Startup* will energise. This configurable setting allows (for instance) certain loads to be removed from the generator prior to the set's load switch being closed. This can be used to ensure the initial loading of the set is kept to a minimum, below the *Load Acceptance* specification of the generating set.

The generator is then placed on load. The *Load Shedding Control* scheme begins.

When the load reaches the *Load Shedding Trip* level the *Trip Delay* timer will start. If the generator loading is still high when the timer expires, the first *Load shedding Control* output will energise. When the load has been above the trip level for the duration of the timer the 'next' *Load shedding Control* output will energise and so on until all *Load Shedding Control* outputs are energised.

If at any time the load falls back below the *Load Shedding Return* level, the *Return Time* will start. If the load remains below the return level when the timer has expired the 'highest' *Load Shedding Control* output that has been energised will be de-energised. This process will continue until all outputs have been de-energised.

When the set enters a stopping sequence for any reason the *Load Shedding control* outputs will de-energise at the same time as the generator load switch is signalled to open.

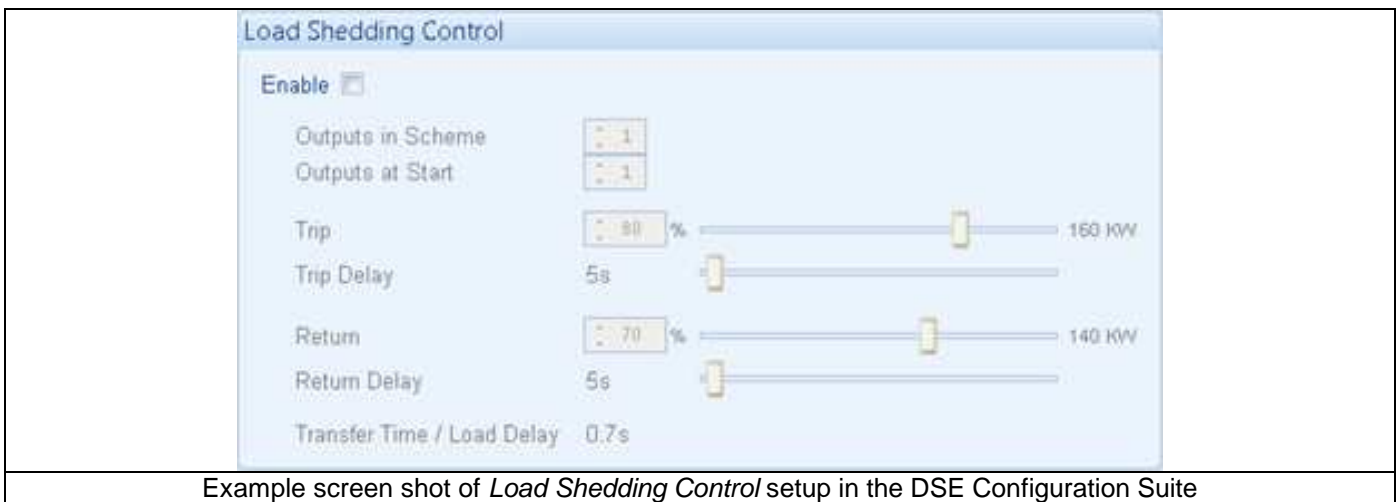

Example screen shot of *Load Shedding Control* setup in the DSE Configuration Suite

6.3 SMS CONTROL

NOTE:- Only available in version DSE73xx version 8+ modules with a suitable GSM modem connected to the RS232 port and configured to receive the control commands.

The *SMS Control* feature (if enabled) allows the user to send control commands to a DSE73xx via SMS message. There are five control commands that the user can send to the module, these control commands are in the table below.

NOTE:- Multiple SMS Control Commands CANNOT be sent in a single SMS message.

| Control Command Number | Module Action |
|------------------------|---|
| 1 | Start the generator off load if in the 'Auto' position. |
| 2 | Start the generator on load if in the 'Auto' position.. |
| 3 | Cancel an SMS start request. |
| 4 | Put the module into the 'STOP' position. |
| 5 | Put the module into the 'AUTO' position. |

To send an SMS command, the user will need (if configured) the *SMS Control Pin Number* and the *Control Command Number*. Only these numbers must be included in the SMS, the module will not respond to any SMS with extra characters or missing PIN number (if configured). Below is an example how to start and run the generator on load by SMS message.

NOTE:- There must be a space between the *SMS PIN Number* and the *Control Command Number*

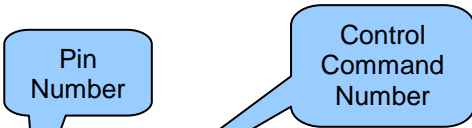

| |
|---------------|
| SMS Message 1 |
| 0123 5 |

This SMS message will place the module into the AUTO position.

| |
|---------------|
| SMS Message 2 |
| 0123 2 |

This SMS message will start and run the generator on load..

| |
|--------------|
| SMS Message3 |
| 0123 3 |

This SMS message will remove the start and run command given by the previous SMS message and leave the module in the AUTO position

| |
|---------------|
| SMS Message 4 |
| 0123 4 |

This SMS message will place the module into the STOP position.

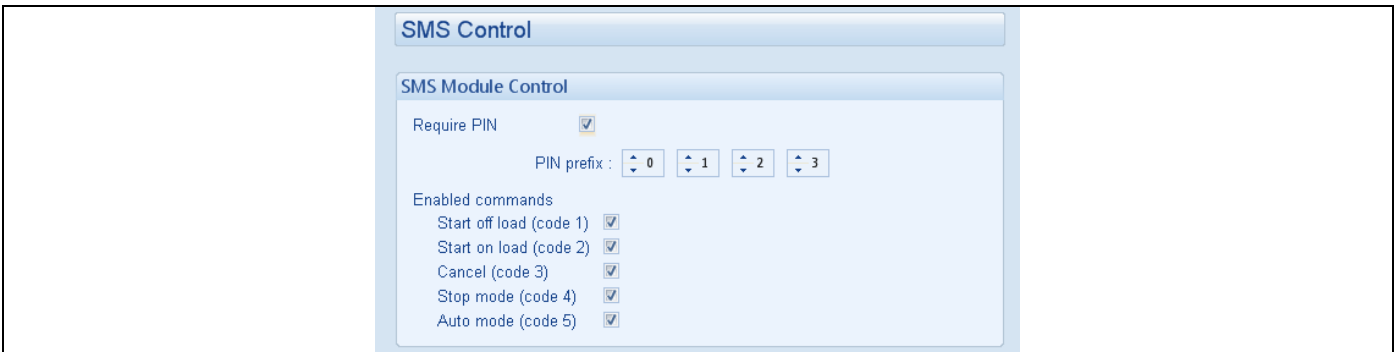

Example screen shot of *SMS Control* setup in the DSE Configuration Suite

6.4 STOP MODE

STOP mode is activated by pressing the  button.

In STOP mode, the module will remove the generator from load (if necessary) before stopping the engine if it is already running.

If the engine does not stop when requested, the FAIL TO STOP alarm is activated (subject to the setting of the *Fail to Stop* timer). To detect the engine at rest the following must occur :

- Engine speed is zero as detected by the Magnetic Pickup or CANbus ECU (depending upon module variant).
- Generator frequency must be zero.
- Oil pressure switch must be closed to indicate low oil pressure (MPU version only)

When the engine has stopped, it is possible to send configuration files to the module from DSE Configuration Suite PC software and to enter the Front Panel Editor to change parameters.

Any latched alarms that have been cleared will be reset when STOP mode is entered.

The engine will not be started when in STOP mode. If remote start signals are given, the input is ignored until AUTO mode is entered.

When configured to do so, if the generator has been on load, pressing the stop button will open the generator breaker and force it to do a cooling run. If the stop button is activated again during the cooling run, the generator will stop instantly.

When configured to do so, When left in STOP mode for five minutes with no presses of the fascia buttons, the module enters low power mode. To 'wake' the module, press the  button or any other fascia control button.

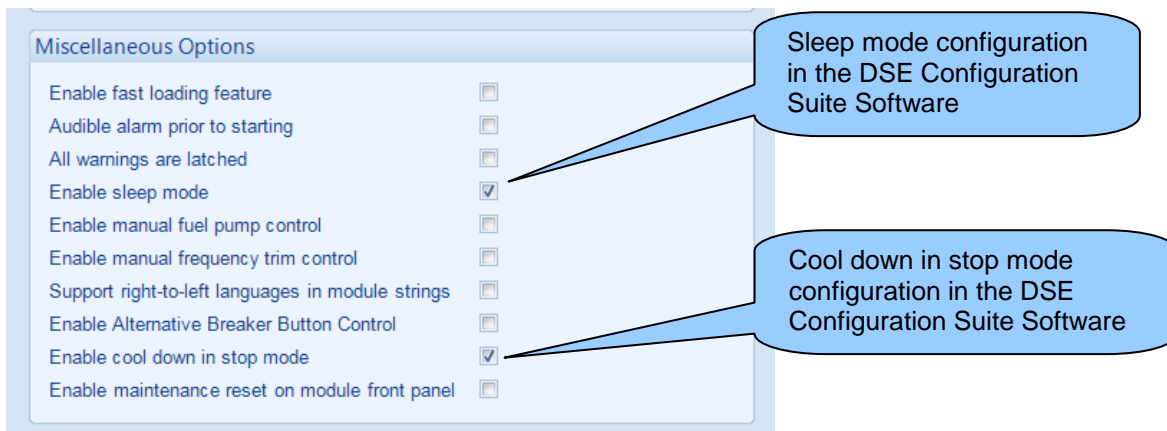

| Miscellaneous Options | |
|---|-------------------------------------|
| Enable fast loading feature | <input type="checkbox"/> |
| Audible alarm prior to starting | <input type="checkbox"/> |
| All warnings are latched | <input type="checkbox"/> |
| Enable sleep mode | <input checked="" type="checkbox"/> |
| Enable manual fuel pump control | <input type="checkbox"/> |
| Enable manual frequency trim control | <input type="checkbox"/> |
| Support right-to-left languages in module strings | <input type="checkbox"/> |
| Enable Alternative Breaker Button Control | <input type="checkbox"/> |
| Enable cool down in stop mode | <input checked="" type="checkbox"/> |
| Enable maintenance reset on module front panel | <input type="checkbox"/> |

Sleep mode configuration in the DSE Configuration Suite Software

Cool down in stop mode configuration in the DSE Configuration Suite Software



6.4.1 ECU OVERRIDE

 **NOTE:- ECU Override function is only applicable when the controller is configured for a CAN engine.**

 **NOTE:- Depending upon system design, the ECU may be powered or unpowered when the module is in STOP mode. ECU override is only applicable if the ECU is unpowered when in STOP mode.**

When the ECU powered down (as is normal when in STOP mode), it is not possible to read the diagnostic trouble codes or instrumentation. Additionally, it is not possible to use the engine manufacturers' configuration tools.

As the ECU is usually unpowered when the engine is not running, it must be turned on manually as follows :

- Select STOP  mode on the DSE controller.
- Press and hold the START  button to power the ECU. As the controller is in STOP mode, the engine will not be started.
- The ECU will remain powered 2 minutes after the START button is released.

This is also useful if the engine manufacturer's tools need to be connected to the engine, for instance to configure the engine as the ECU needs to be powered up to perform this operation.

6.5 AUTOMATIC MODE

NOTE:- If a digital input configured to *panel lock* is active, changing module modes will not be possible. Viewing the instruments and event logs is NOT affected by panel lock.

Activate auto mode by pressing the  pushbutton. An LED indicator beside the button confirms this action.

Auto mode will allow the generator to operate fully automatically, starting and stopping as required with no user intervention.

6.5.1 WAITING IN AUTO MODE

If a starting request is made, the starting sequence will begin.

Starting requests can be from the following sources:

- Mains supply out of limits (DSE7220/7320 only)
- Activation of an auxiliary input that has been configured to *remote start on load* or *remote start off load*.
- Activation of the inbuilt exercise scheduler.
- Instruction from external remote telemetry devices using the RS232 or RS485 interface (DSE7310/DSE7320 only).

6.5.2 STARTING SEQUENCE

To allow for 'false' start requests such as mains brownouts, the *start delay* timer begins. There are individual start delay timers for each of the different start request types.

Should all start requests be removed during the *start delay* timer, the unit will return to a stand-by state.

If a start request is still present at the end of the *start delay* timer, the fuel relay is energised and the engine will be cranked.

NOTE:- If the unit has been configured for CAN, compatible ECU's will receive the start command via CAN.

If the engine fails to fire during this cranking attempt then the starter motor is disengaged for the *crank rest* duration after which the next start attempt begins. Should this sequence continue beyond the set number of attempts, the start sequence will be terminated and the display shows **Fail to Start**.

The starter motor is disengaged when the engine fires. Speed detection is factory configured to be derived from the main alternator output frequency, but can additionally be measured from a Magnetic Pickup mounted on the flywheel (Selected by PC using the 7000 series configuration software).

Additionally, rising oil pressure can be used to disconnect the starter motor (but cannot detect underspeed or overspeed).

NOTE:- If the unit has been configured for CAN, speed sensing is via CAN.

After the starter motor has disengaged, the *Safety On* timer activates, allowing Oil Pressure, High Engine Temperature, Under-speed, Charge Fail and any delayed Auxiliary fault inputs to stabilise without triggering the fault.

6.5.3 ENGINE RUNNING

Once the engine is running, the *Warm Up* timer, if selected, begins, allowing the engine to stabilise before accepting the load.

DSE7210/DSE7310 - The generator will be placed on load.

DSE7220/DSE7320 - Load will be transferred from the mains supply to the generator



NOTE:-The load transfer signal remains inactive until the Oil Pressure has risen. This prevents excessive wear on the engine.

As the load increases and decreases, the DSE7300 series module (not available on DSE7200 series) may (depending upon configuration) add dummy loads or remove non-essential loads. This is configured as part of the *Load Shedding* and *Dummy Load* control settings in the DSE Configuration Suite Software. See section entitled *Dummy Load / Load Shedding* elsewhere in this document for further details.

If all start requests are removed, the *stopping sequence* will begin.

6.5.4 STOPPING SEQUENCE

The *return delay* timer operates to ensure that the starting request has been permanently removed and isn't just a short term removal. Should another start request be made during the cooling down period, the set will return on load.

If there are no starting requests at the end of the *return delay* timer, the load is transferred back from the generator to the mains supply and the *cooling* timer is initiated.

The *cooling* timer allows the set to run off load and cool sufficiently before being stopped. This is particularly important where turbo chargers are fitted to the engine.

After the *cooling* timer has expired, the set is stopped.

6.6 MANUAL MODE

NOTE:- If a digital input configured to *panel lock* is active, changing module modes will not be possible. Viewing the instruments and event logs is NOT affected by panel lock.

Activate Manual mode by pressing the  pushbutton. An LED indicator beside the button confirms this action.

Manual mode allows the operator to start and stop the set manually, and if required change the state of the load switching devices.

6.6.1 WAITING IN MANUAL MODE

When in manual mode, the set will not start automatically.

To begin the starting sequence, press the  button.

6.6.2 STARTING SEQUENCE

NOTE:- There is no *start delay* in this mode of operation.

The fuel relay is energised and the engine is cranked.

NOTE:- If the unit has been configured for CAN, compatible ECU's will receive the start command via CAN.

If the engine fails to fire during this cranking attempt then the starter motor is disengaged for the *crank rest* duration after which the next start attempt is made. Should this sequence continue beyond the set number of attempts, the start sequence will be terminated and the display shows **Fail to Start**.

When the engine fires, the starter motor is disengaged. Speed detection is factory configured to be derived from the main alternator output frequency but can additionally be measured from a Magnetic Pickup mounted on the flywheel (Selected by PC using the 7000 series configuration software).

Additionally, rising oil pressure can be used to disconnect the starter motor (but cannot detect underspeed or overspeed).

NOTE:- If the unit has been configured for CAN, speed sensing is via CAN.

After the starter motor has disengaged, the *Safety On* timer activates, allowing Oil Pressure, High Engine Temperature, Under-speed, Charge Fail and any delayed Auxiliary fault inputs to stabilise without triggering the fault.



6.6.3 ENGINE RUNNING

In manual mode, the load is not transferred to the generator unless a 'loading request' is made. A loading request can come from a number of sources.

- Pressing the *transfer to generator*  button
- Mains supply out of limits (DSE7220/DSE7320 only)
- Activation of an auxiliary input that has been configured to *remote start on load*
- Activation of the inbuilt exercise scheduler if configured for 'on load' runs.

NOTE:-The load transfer signal remains inactive until the Oil Pressure has risen. This prevents excessive wear on the engine.





Once the load has been transferred to the generator, it will not be automatically transferred back to the mains supply. To manually transfer the load back to the mains either:

- Press the *transfer to mains*  button (DSE7220/DSE7320 only)
- Press the *Open Generator* button (DSE7210/DSE7310 only)
- Press the *auto mode*  button to return to automatic mode.

For further details of breaker control, see the section entitled "controls and indications" elsewhere in this manual.





6.6.4 MANUAL FUEL PUMP CONTROL

NOTE:-Manual Fuel Pump Control is only available on suitably configured systems with V3 or higher control modules. Consult your set supplier for further advice.

- Navigate to the instruments page using the  buttons and locate FUEL LEVEL.  is shown on the module display to indicate that this feature is available.
- Press and hold the  button to energise the transfer pump. The pump starts two seconds after the button is pressed.
- Release the  button to de-energise the transfer pump.



6.6.5 MANUAL SPEED CONTROL

NOTE:-Manual Speed Control is only available on suitably configured systems with V3 or higher control modules. Consult your set supplier for further advice.

- Navigate to the instruments page using the  buttons and locate ENGINE SPEED.  is shown on the module display to indicate that this feature is available.
- Press the  button to enter edit mode
- Press  (up or down) to change the engine speed.
- Press the  button again to exit the editor and leave the engine running at the newly selected speed.

6.6.6 STOPPING SEQUENCE

In manual mode the set will continue to run until either :

- The *stop button*  is pressed – The set will stop immediately or after off load cooling run depending upon configuration.
- The *auto button*  is pressed. The set will observe all auto mode start requests and stopping timers before beginning the *Auto mode stopping sequence*.

6.7 TEST MODE

 **NOTE:- Test Mode is only applicable to DSE7220/DSE7320 controllers.**

 **NOTE:- If a digital input configured to *panel lock* is active, changing module modes will not be possible. Viewing the instruments and event logs is NOT affected by panel lock.**

Activate test mode by pressing the  pushbutton. An LED indicator beside the button confirms this action.

Test mode will start the set and transfer the load to the generator to provide a **Test on load** function.

6.7.1 WAITING IN TEST MODE

When in test mode, the set will not start automatically.

To begin the starting sequence, press the  button.

6.7.2 STARTING SEQUENCE

The set begins to crank.

 **NOTE:- If the unit has been configured for CAN, compatible ECU's will receive the start command via CAN.**

If the engine fails to fire during this cranking attempt then the starter motor is disengaged for the *crank rest* duration after which the next start attempt is made. Should this sequence continue beyond the set number of attempts, the start sequence will be terminated and the display shows **Fail to Start**.

When the engine fires, the starter motor is disengaged. Speed detection is factory configured to be derived from the main alternator output frequency but can additionally be measured from a Magnetic Pickup mounted on the flywheel (Selected by PC using the 7000 series configuration software).

Additionally, rising oil pressure can be used to disconnect the starter motor (but cannot detect underspeed or overspeed).

 **NOTE:- If the unit has been configured for CAN, speed sensing is via CAN.**

After the starter motor has disengaged, the *Safety On* timer activates, allowing Oil Pressure, High Engine Temperature, Under-speed, Charge Fail and any delayed Auxiliary fault inputs to stabilise without triggering the fault.



6.7.3 ENGINE RUNNING

Once the engine is running, the *Warm Up* timer, if selected, begins, allowing the engine to stabilise before accepting the load.

Load will be automatically transferred from the mains supply to the generator.

 **NOTE:-The load transfer signal remains inactive until the Oil Pressure has risen. This prevents excessive wear on the engine.**

In test mode, the set will continue to run *on load* until either:

- The *stop button*  is pressed – The set will stop immediately or after off load cooling run depending upon configuration.
- The *auto button*  is pressed. The set will observe all auto mode start requests and stopping timers before beginning the *Auto mode stopping sequence*.

7 OPERATION (DUAL MUTUAL STANDBY)

NOTE:- Dual Mutual Standby is only available in DSE7210 and DSE7310 series V2.0 or above.
Load Balancing is only available in DSE7000 series V4 or above.

The following description details the sequences followed by a module containing the standard 'factory configuration' modified to allow two controllers to operate in Dual Mutual Standby.

The operating modes are as per *Standalone* operation with the dual mutual functions detailed below.

Remember that if you have purchased a completed generator set or control panel from your supplier, the module's configuration will probably have been changed by them to suit their particular requirements.

Always refer to your configuration source for the exact sequences and timers observed by any particular module in the field.

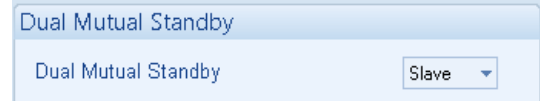
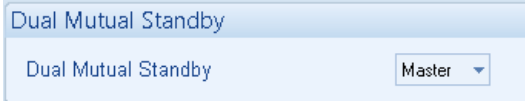

Screen shot from DSE Configuration Suite PC Software showing the configuration of the *Master* and *Slave* controllers.

Dual Mutual Standby will allow the generators to operate fully automatically, starting and stopping as required with no user intervention, with the *master* backed up by the *slave*. It is also possible to configure the master to change duty based upon a scheduler, to allow for 'load balancing' (V4 or above only)

If a starting request is made, the starting sequence will begin.
Starting requests can be from the following sources:

- Activation of an auxiliary input that has been configured to *remote start*
 - It is usual that one remote start signal controls both modules. In this instance, the *Master* will start its generator. Should the *Master* fail, it instructs the *Slave* to start and take the load.
 - If the *Master* is running and the remote start signal is given to the *Slave*, the *Slave* will not start its generator until the *Master* generator fails.
- Activation of the inbuilt exercise scheduler.
 - In dual mutual standby operation the scheduler operates totally independently to the *Master/Slave* scheme. Both generators could start, but only one will be allowed to close its load switching device to power the load.

NOTE:- In all operating modes, only one module will be permitted to close its load switching device.

8 PROTECTIONS

When an alarm is present, the Audible Alarm will sound and the Common alarm LED if configured will illuminate.

The audible alarm can be silenced by pressing the *Mute button* 

The LCD display will jump from the 'Information page' to display the Alarm Page

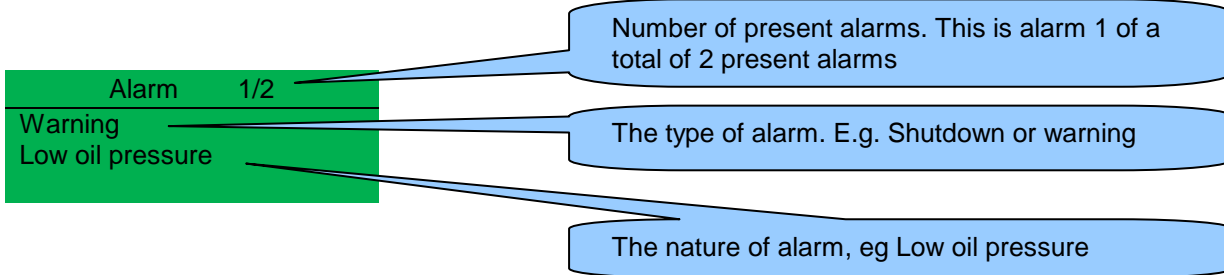

The LCD will display multiple alarms E.g. "High Engine Temperature shutdown", "Emergency Stop" and "Low Coolant Warning". These will automatically scroll in the order that they occurred.

In the event of a warning alarm, the LCD will display the appropriate text. If a shutdown then occurs, the module will again display the appropriate text.

Example:-

| | |
|---------|------------------|
| Alarm | 1/2 |
| Warning | Oil pressure Low |

| | |
|----------|--------------------------|
| Alarm | 2/2 |
| Shutdown | Coolant Temperature High |

8.1 PROTECTIONS DISABLED

 **NOTE:- This feature is available in module versions 4 and above.**

User configuration is possible to prevent Shutdown / Electrical Trip alarms from stopping the engine. Under such conditions, *Protections Disabled* will appear on the module display to inform the operator of this status.

This feature is provided to assist the system designer in meeting specifications for “Warning only”, “Protections Disabled”, “Run to Destruction”, “War mode” or other similar wording.

When configuring this feature in the PC software, the system designer chooses to make the feature either permanently active, or only active upon operation of an external switch. The system designer provides this switch (not DSE) so its location will vary depending upon manufacturer, however it normally takes the form of a key operated switch to prevent inadvertent activation. Depending upon configuration, a warning alarm may be generated when the switch is operated.

The feature is configurable in the PC configuration software for the module. Writing a configuration to the controller that has “Protections Disabled” configured, results in a warning message appearing on the PC screen for the user to acknowledge before the controller’s configuration is changed. This prevents inadvertent activation of the feature.

8.1.1 INDICATION / WARNING ALARMS

Under Indication or Warning alarms :

- The module operation is unaffected by the *Protections Disabled* feature. See sections entitled *Indications* and *Warnings* elsewhere in this document.

8.1.2 SHUTDOWN / ELECTRICAL TRIP ALARMS

 **NOTE:- The EMERGENCY STOP input and shutdown alarm continues to operate even when *Protections Disabled* has been activated.**

Under Shutdown or Electrical Trip alarm conditions (excluding Emergency Stop) :

- The alarm is displayed on the screen as detailed in the section entitled *Shutdown alarms* elsewhere in this document.
- The set continues to run.
- The load switch maintains its current position (it is not opened if already closed)
- **Shutdown Blocked** also appears on the LCD screen to inform the operator that the Protections Disabled feature has blocked the shutdown of the engine under the normally critical fault.
- The ‘shutdown’ alarm is logged by the controllers *Event Log* (if configured to log shutdown alarms) and also logs that the Shutdown was prevented.

8.1.3 CAN ALARMS

 **NOTE:- Please refer to the engine manufacturer's documentation for Can error message information.**

CAN alarms are messages sent from the CAN ECU to the DSE controller and displayed as follows in the below tables.

| Display | Reason |
|------------------------|--|
| CAN ECU WARNING | The engine ECU has detected a warning alarm and has informed the DSE module of this situation. The exact error is also indicated on the module's display and action taken depending upon the setting for the DM1 signals |
| ECU SHUTDOWN | The engine ECU has detected a shutdown alarm and has informed the DSE module of this situation. The exact error is also indicated on the module's display. |
| ECU DATA FAIL | The module is configured for CAN operation and does not detect data on the engine CAN datalink, the engine shuts down. |

DM1 Signals. Messages from the CAN ECU that are configurable within the DSE module for:-
Warning, Electrical Trip, shutdown or None

| Display | Reason |
|----------------------|---|
| Amber Warning | The CAN ECU has detected a Amber warning. |
| Red Shutdown | The CAN ECU has detected a Red Shutdown. |
| Malfunction | The CAN ECU has detected a Malfunction message. |
| Protect | The CAN ECU has detected a Protect message |

Advanced CAN alarms Allows configuration of additional can messages from the engine ECU.

| Display | Reason |
|------------------------|---|
| Water in Fuel | The ECU has detected water in the fuel action taken is set by settings in advanced. |
| After Treatment | The ECU has detected "After Treatment alarm" consult engine manufacturer for details" action taken by DSE controller is set by settings in advanced |

 **NOTE:- For CAN ECU error code meanings, refer to the ECU documentation provided by the engine manufacturer, or contact the engine manufacturer for further assistance.**

8.2 INDICATIONS

Indications are non-critical and often status conditions. They do not appear on the LCD of the module as a text message. However an output or LED indicator can be configured to draw the operators attention to the event.

Example

- Input configured for indication.
- The LCD text will not appear on the module display but can be added in the configuration to remind the system designer what the input is used for.
- As the input is configured to *Indication* there is no alarm generated.
- LED Indicator to make LED1 illuminate when Digital Input A is active.
- The Insert Card Text allows the system designer to print an insert card detailing the LED function.
- Sample showing operation of the LED.

Digital Input A

Function: User Configured

Polarity: Close to Activate

Action: Indication

Arming: Always

LCD Display: Battery Charger On

Activation Delay: 0s

LED Indicators

1 Digital Input A Lit Battery Charger On

Insert Card Text



8.3 WARNINGS

Warnings are non-critical alarm conditions and do not affect the operation of the generator system, they serve to draw the operators attention to an undesirable condition.

Example

| | |
|------------------------|-----|
| Alarm | 1/1 |
| Charge Failure Warning | |

In the event of an alarm the LCD will jump to the alarms page, and scroll through all active warnings and shutdowns.

By default, warning alarms are self-resetting when the fault condition is removed. However enabling 'all warnings are latched' will cause warning alarms to latch until reset manually. This is enabled using the 7000 series configuration suite in conjunction with a compatible PC.

| Display | Reason |
|--|---|
| CHARGE FAILURE | The auxiliary charge alternator voltage is low as measured from the W/L terminal. |
| BATTERY UNDER VOLTAGE | The DC supply has fallen below the low volts setting level for the duration of the low battery volts timer |
| BATTERY OVER VOLTAGE | The DC supply has risen above the high volts setting level for the duration of the high battery volts timer |
| FAIL TO STOP | The module has detected a condition that indicates that the engine is running when it has been instructed to stop. <div style="border: 1px solid black; padding: 5px;"> <p>⚠ NOTE:- 'Fail to Stop' could indicate a faulty oil pressure sensor or switch - If the engine is at rest check oil sensor wiring and configuration.</p> </div> |
| FUEL USAGE | Indicates the amount of fuel measured by the fuel level sensor is in excess of the <i>Fuel Usage</i> alarm settings. This often indicates a fuel leak or potential fuel theft. |
| AUXILIARY INPUTS | Auxiliary inputs can be user configured and will display the message as written by the user. |
| LOW FUEL LEVEL | The level detected by the fuel level sensor is below the low fuel level setting. |
| kW OVERLOAD | The measured Total kW is above the setting of the kW overload warning alarm |
| EARTH FAULT (DSE7300 series V2.0 or above only) | The measured Earth Fault Current has been in excess of the earth fault trip and has surpassed the IDMT curve of the Earth Fault alarm. |
| NEGATIVE PHASE SEQUENCE (DSE7000 series V2.0 or above only) | Indicates 'out of balance' current loading of the generator. Sometimes also called Negative Sequence Current or Symmetry Fault |
| MAINTENANCE DUE (DSE7000 series V2.1 or above only) | Indicates that the maintenance alarm has triggered. A visit is required by the Generator service company. |
| LOADING VOLTAGE NOT REACHED | Indicates that the generator voltage is not above the configured <i>loading voltage</i> . The generator will not take load when the alarm is present after the safety timer. |
| LOADING FREQUENCY NOT REACHED | Indicates that the generator frequency is not above the configured <i>loading frequency</i> . The generator will not take load when the alarm is present after the safety timer. |

| | |
|----------------------------------|---|
| PROTECTIONS DISABLED | Shutdown and electrical trip alarms can be disabled by user configuration. In this case, Protections Disabled will appear on the module display; The alarm text will be displayed but the engine will continue to run. This is 'logged' by the module to allow DSE Technical Staff to check if the protections have been disabled on the module at any time. This feature is available from V4 onwards. |
| LOW OIL PRESSURE | The module detects that the engine oil pressure has fallen below the low oil pressure pre-alarm setting level after the <i>Safety On</i> timer has expired. |
| ENGINE HIGH TEMPERATURE | The module detects that the engine coolant temperature has exceeded the high engine temperature pre-alarm setting level after the <i>Safety On</i> timer has expired. |
| ENGINE LOW TEMPERATURE | The module detects that the engine coolant temperature has fallen below the high engine temperature pre-alarm setting level. |
| OVERSPEED | The engine speed has risen above the overspeed pre alarm setting |
| UNDERSPEED | The engine speed has fallen below the underspeed pre alarm setting |
| GENERATOR OVER FREQUENCY | The generator output frequency has risen above the pre-set pre-alarm setting. |
| GENERATOR UNDER FREQUENCY | The generator output frequency has fallen below the pre-set pre-alarm setting after the <i>Safety On</i> timer has expired. |
| GENERATOR OVER VOLTAGE | The generator output voltage has risen above the pre-set pre-alarm setting. |
| GENERATOR UNDER VOLTAGE | The generator output voltage has fallen below the pre-set pre-alarm setting after the <i>Safety On</i> timer has expired. |
| ECU WARNING | The engine ECU has detected a warning alarm and has informed the DSE module of this situation. The exact error is also indicated on the module's display. |

If the module is configured for **CAN** and receives an "error" message from the engine control unit, 'Can ECU Warning' is shown on the module's display and a warning alarm is generated.

8.4 HIGH CURRENT WARNING ALARM

GENERATOR HIGH CURRENT, if the module detects a generator output current in excess of the pre-set trip a warning alarm initiates. The module shows Alarm Warning High Current. If this high current condition continues for an excess period, then the alarm escalates to a shutdown condition. For further details of the high current alarm, please see High Current Shutdown Alarm.

By default, High Current Warning Alarm is self-resetting when the overcurrent condition is removed. However enabling 'all warnings are latched' will cause the alarm to latch until reset manually. This is enabled using the 7000 series configuration suite in conjunction with a compatible PC.

8.5 SHUTDOWNS

NOTE:- Shutdown and Electrical Trip alarms can be disabled by user configuration. See the section entitled *Protections Disabled* elsewhere in this document.

Shutdowns are latching alarms and stop the Generator. Clear the alarm and remove the fault then press Stop/Reset  to reset the module.

Example

| | |
|---------------------------|-----|
| Alarm | 1/1 |
| Oil Pressure Low Shutdown | |

NOTE:- The alarm condition must be rectified before a reset will take place. If the alarm condition remains, it will not be possible to reset the unit (The exception to this is the Low Oil Pressure alarm and similar 'active from safety on' alarms, as the oil pressure will be low with the engine at rest).

| Display | Reason |
|---|--|
| EARTH FAULT (DSE7300 series V2.0 or above only) | The measured Earth Fault Current has been in excess of the earth fault trip and has surpassed the IDMT curve of the Earth Fault alarm. |
| FAIL TO START | The engine has not fired after the preset number of start attempts |
| EMERGENCY STOP | <p>The emergency stop button has been depressed. This a failsafe (normally closed to battery positive) input and will immediately stop the set should the signal be removed.</p> <p>Removal of the battery positive supply from the emergency stop input will also remove DC supply from the Fuel and Start outputs of the controller.</p> <div style="border: 1px solid black; padding: 5px; margin-top: 10px;"> <p>NOTE:- The Emergency Stop Positive signal must be present otherwise the unit will shutdown.</p> </div> |
| LOW OIL PRESSURE | The engine oil pressure has fallen below the low oil pressure trip setting level after the <i>Safety On</i> timer has expired. |
| ENGINE HIGH TEMPERATURE | The engine coolant temperature has exceeded the high engine temperature trip setting level after the <i>Safety On</i> timer has expired. |
| FUEL USAGE | Indicates the amount of fuel measured by the fuel level sensor is in excess of the <i>Fuel Usage</i> alarm settings. This often indicates a fuel leak or potential fuel theft. |
| PHASE ROTATION (DSE7000 series V2.0 or above only) | The phase rotation is measured as being different to the configured direction. |
| OVERSPEED | <p>The engine speed has exceeded the pre-set trip</p> <div style="border: 1px solid black; padding: 5px; margin-top: 10px;"> <p>NOTE:-During the start-up sequence, the overspeed trip logic can be configured to allow an extra trip level margin. This is used to prevent nuisance tripping on start-up - Refer to the 7000 series configuration software manual under heading 'Overspeed Overshoot' for details.</p> </div> |
| UNDERSPEED | The engine speed has fallen below the pre-set trip after the <i>Safety On</i> timer has expired. |

| Display | Reason |
|--|---|
| GENERATOR OVER FREQUENCY | The generator output frequency has risen above the preset level |
| GENERATOR UNDER FREQUENCY | The generator output frequency has fallen below the preset level |
| GENERATOR OVER VOLTAGE | The generator output voltage has risen above the preset level |
| GENERATOR UNDER VOLTAGE | The generator output voltage has fallen below the preset level |
| OIL PRESSURE SENSOR OPEN CIRCUIT | The oil pressure sensor is detected as not being present (open circuit) |
| AUXILIARY INPUTS | An active auxiliary input configured as a shutdown will cause the engine to shut down. The display shows the text as configured by the user. |
| LOSS OF SPEED SIGNAL | The speed signal from the magnetic pickup is not being received by the DSE controller. |
| ECU DATA FAIL | The module is configured for CAN operation and does not detect data on the engine Can datalink, the engine shuts down. |
| ECU SHUTDOWN | The engine ECU has detected a shutdown alarm and has informed the DSE module of this situation. The exact error is also indicated on the module's display. |
| kW OVERLOAD | The measured Total kW is above the setting of the kW overload shutdown alarm |
| NEGATIVE PHASE SEQUENCE (DSE7000 series V2.0 or above only) | Indicates 'out of balance' current loading of the generator. Sometimes also called Negative Sequence Current or Symmetry Fault |
| MAINTENANCE DUE (DSE7000 series V2.1 or above only) | Indicates that the maintenance alarm has triggered. A visit is required by the Generator service company. |
| GENERATOR HIGH CURRENT | A High Current condition has continued for an excess period, then the alarm escalates to either a shutdown or electrical trip condition (depending upon module configuration). For further details of the high current alarm, please see High Current Shutdown / Electrical Trip Alarm. |
| LOADING VOLTAGE NOT REACHED | Indicates that the generator voltage is not above the configured <i>loading voltage</i> after the safety timer. The generator will shutdown. |
| LOADING FREQUENCY NOT REACHED | Indicates that the generator frequency is not above the configured <i>loading frequency</i> after the safety timer. The generator will shutdown. |
| PROTECTIONS DISABLED | Shutdown and electrical trip alarms can be disabled by user configuration. In this case, Protections Disabled will appear on the module display; The alarm text will be displayed but the engine will continue to run. This is 'logged' by the module to allow DSE Technical Staff to check if the protections have been disabled on the module at any time. This feature is available from V4 onwards. |

8.6 ELECTRICAL TRIPS

NOTE:- Shutdown and Electrical Trip alarms can be disabled by user configuration. See the section entitled *Protections Disabled* elsewhere in this document.

Electrical trips are latching and stop the Generator but in a controlled manner. On initiation of the electrical trip condition the module will de-energise the '**Close Generator**' Output to remove the load from the generator. Once this has occurred the module will start the Cooling timer and allow the engine to cool off-load before shutting down the engine. The alarm must be accepted and cleared, and the fault removed to reset the module.

Example

| | |
|---|-----|
| Alarm | 1/1 |
| Generator Current High Electrical Trip | |

Electrical trips are latching alarms and stop the Generator. Remove the fault then press Stop/Reset  to reset the module.

| Display | Reason |
|--|---|
| GENERATOR HIGH CURRENT | If a generator output in excess of the high current alarm point, a warning alarm occurs. If this high current condition continues for an excess period, then the alarm escalates to either a shutdown or electrical trip condition (depending upon module configuration). For further details of the high current alarm, please see High Current Shutdown / Electrical Trip Alarm. |
| AUXILIARY INPUTS | If an auxiliary input configured as an electrical trip is active, the appropriate message will be displayed as configured by the user. |
| KW OVERLOAD | The measured Total kW is above the setting of the kW overload Electrical Trip alarm |
| EARTH FAULT (DSE7300 series V2.0 or above only) | The measured Earth Current is above the setting of the Earth fault alarm. |
| NEGATIVE PHASE SEQUENCE (DSE7000 series V2.0 or above only) | Indicates 'out of balance' current loading of the generator. Sometimes also called Negative Sequence Current or Symmetry Fault |
| FUEL USAGE | Indicates the amount of fuel used is in excess of the <i>Fuel Usage</i> alarm settings. This often indicates a fuel leak or potential fuel theft. |
| LOADING VOLTAGE NOT REACHED | Indicates that the generator voltage is not above the configured loading voltage after the safety timer. The generator will shutdown. |
| LOADING FREQUENCY NOT REACHED | Indicates that the generator frequency is not above the configured loading frequency after the safety timer. The generator will shutdown. |
| PROTECTIONS DISABLED | Shutdown and electrical trip alarms can be disabled by user configuration. In this case, Protections Disabled will appear on the module display; The alarm text will be displayed but the engine will continue to run. This is 'logged' by the module to allow DSE Technical Staff to check if the protections have been disabled on the module at any time. This feature is available from V4 onwards. |
| GENERATOR UNDER FREQUENCY | The generator output frequency has fallen below the preset level |
| GENERATOR UNDER VOLTAGE | The generator output voltage has fallen below the preset level |
| UNDERSPEED | The engine speed has fallen below the underspeed setting |

8.7 HIGH CURRENT SHUTDOWN / ELECTRICAL TRIP ALARM

The overcurrent alarm combines a simple warning trip level with a fully functioning IDMT curve for thermal protection.

8.7.1 IMMEDIATE WARNING

If the *Immediate Warning* is enabled, the controller generates a *warning alarm* as soon as the *Trip* level is reached. The alarm automatically resets once the generator loading current falls below the *Trip* level (unless *All Warnings are latched* is enabled). For further advice, consult your generator supplier.

8.7.2 IDMT ALARM

If the *IDMT Alarm* is enabled, the controller begins following the IDMT 'curve' when the *trip* level is passed.

If the *Trip* is surpassed for an excess amount of time the *IDMT Alarm* triggers (*Shutdown* or *Electric trip* as selected in *Action*).

High current shutdown is a latching alarm and stops the Generator.

Remove the fault then press Stop/Reset  to reset the module.

High current electrical trip is a latching alarm and removes the generator from the load, before stopping the Generator after the off load *cooling* timer.

Remove the fault then press Stop/Reset  to reset the module.

The higher the overload, the faster the trip. The speed of the trip is dependent upon the fixed formula:

$$T = t / ((I_A / I_T) - 1)^2$$

Where: T is the tripping time in seconds

I_A is the actual current of the most highly loaded line (L1 or L2 or L3)

I_T is the delayed over-current trip point

t is the time multiplier setting and also represents the tripping time in seconds at twice full load (when $I_A / I_T = 2$).

Factory settings for the *IDMT Alarm* when used on a brushless alternator are as follows (screen capture from the DSE Configuration Suite PC software) :

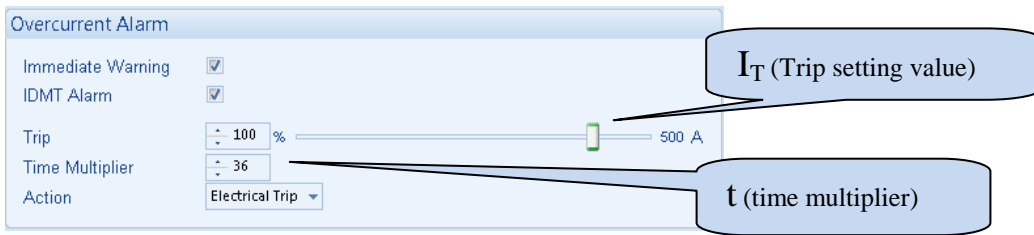

These settings provide for normal running of the generator up to 100% full load. If full load is surpassed, the *Immediate Warning* alarm is triggered, the set continues to run. The effect of an overload on the generator is that the alternator windings begin to overheat; the aim of the *IDMT alarm* is to prevent the windings being overload (heated) too much. The amount of time that the set can be safely overloaded is governed by how high the overload condition is.

With typical settings as above, the tripping curve is followed as shown below.

This allows for overload of the set to the limits of the *Typical Brushless Alternator* whereby 110% overload is permitted for 1 hour.

If the set load reduces, the controller then *follows* a cooling curve. This means that a second overload condition may trip much sooner than the first as the controller *knows* if the windings have not cooled sufficiently.

For further details on the *Thermal damage curve* of your alternator, you are referred to your alternator manufacturer and generator supplier.

Overcurrent alarm IDMT curves

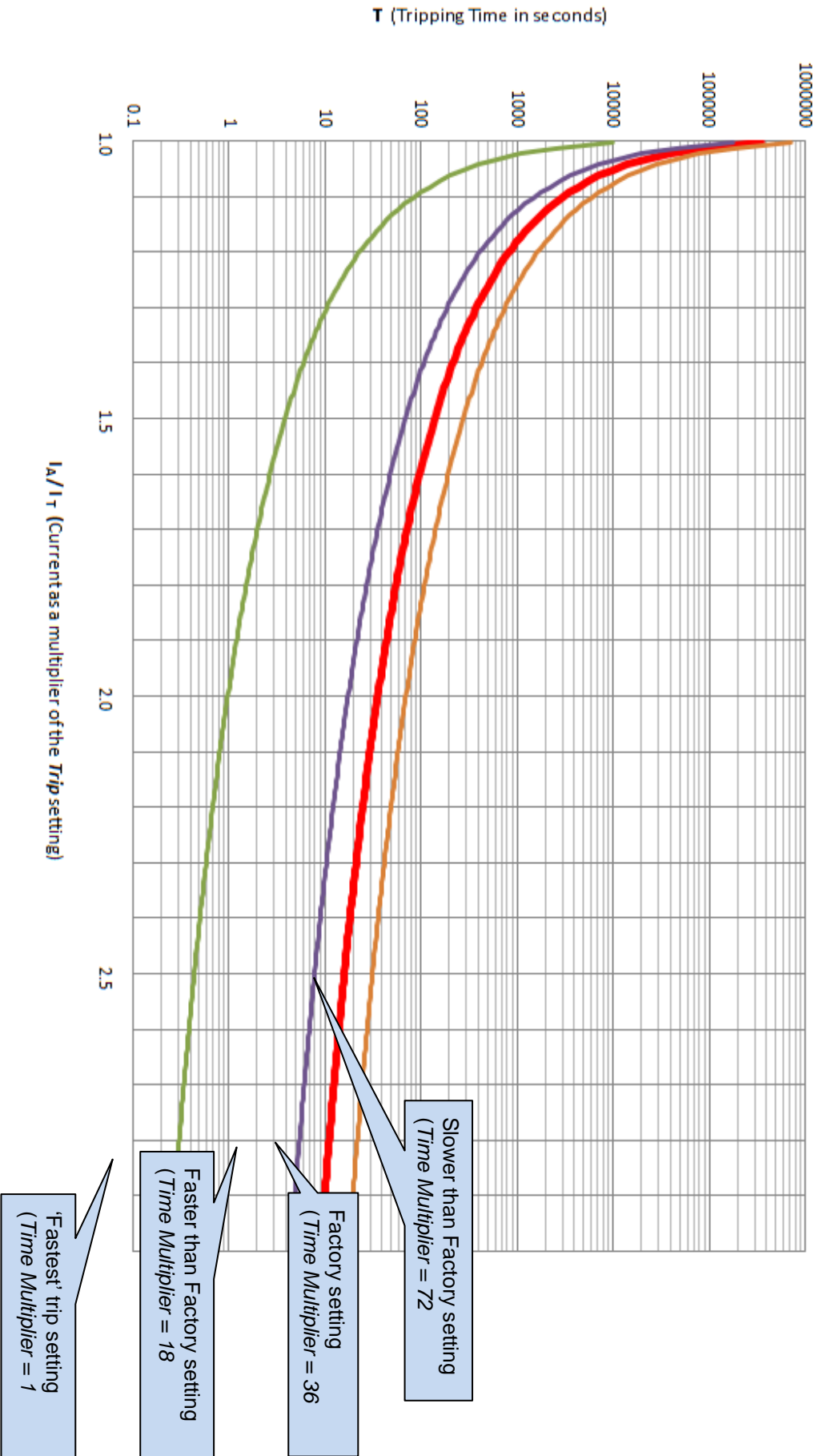

8.8 EARTH FAULT SHUTDOWN / ELECTRICAL TRIP ALARM

When the module is suitably connected using the 'Earth Fault CT'. The module measures Earth Fault and can optionally be configured to generate an alarm condition (shutdown or electrical trip) when a specified level is surpassed.

If the *Earth Fault alarm* is enabled, the controller begins following the IDMT 'curve'. If the *Trip* is surpassed for an excess amount of time the Alarm triggers (*Shutdown* or *Electric trip* as selected in *Action*).

The higher the Earth Fault, the faster the trip. The speed of the trip is dependent upon the fixed formula :

$$T = K \times 0.14 / ((I / I_s)^{0.02} - 1)$$

Where: T is the tripping time in seconds (accurate to +/- 5% or +/- 50ms (whichever is the greater)

K is the time multiplier setting

I is the actual earth current measured

I_s is the trip setting value

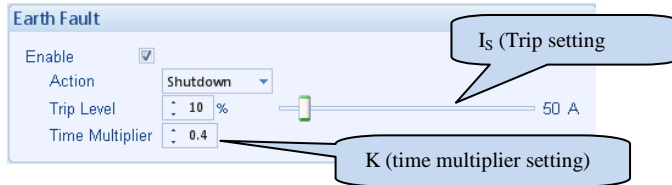

The settings shown in the example above are a screen capture of the DSE factory settings, taken from the DSE Configuration Suite software.

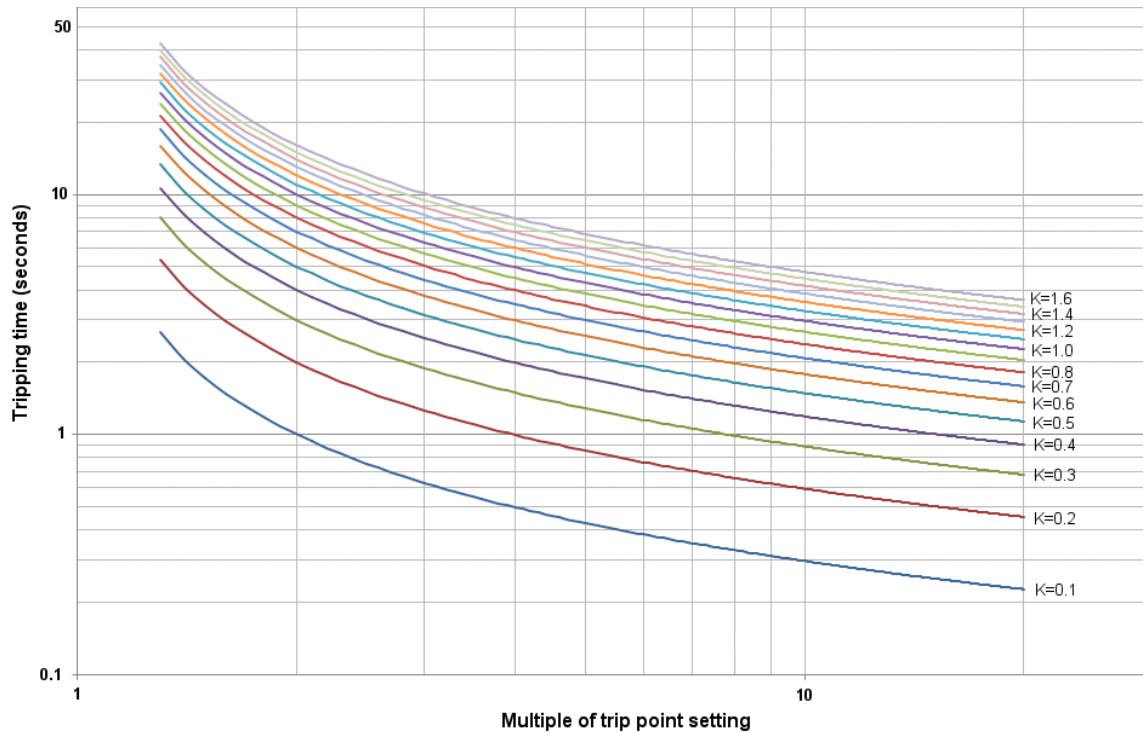

8.9 SHORT CIRCUIT ALARM

If the *Short Circuit alarm* is enabled, the controller begins following the IDMT 'curve'. If the *Trip* is surpassed for an excess amount of time the Alarm triggers (*Shutdown* or *Electrical trip* as selected in *Action*).

The higher the Short Circuit, the faster the trip. The speed of the trip is dependent upon the fixed formula :

$$T = K \times 0.14 / ((I / I_s)^{0.02} - 1)$$

Where: T is the tripping time in seconds (accurate to +/- 5% or +/- 50ms (whichever is the greater))
 K is the time multiplier setting
 I is the actual current measured
 Is is the trip setting value

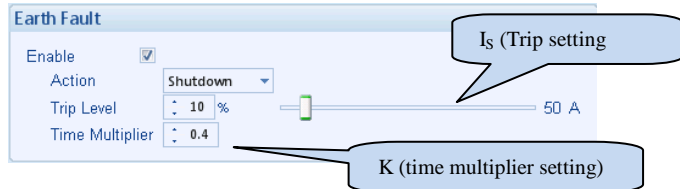

The settings shown in the example above are a screen capture of the DSE factory settings, taken from the DSE Configuration Suite software.

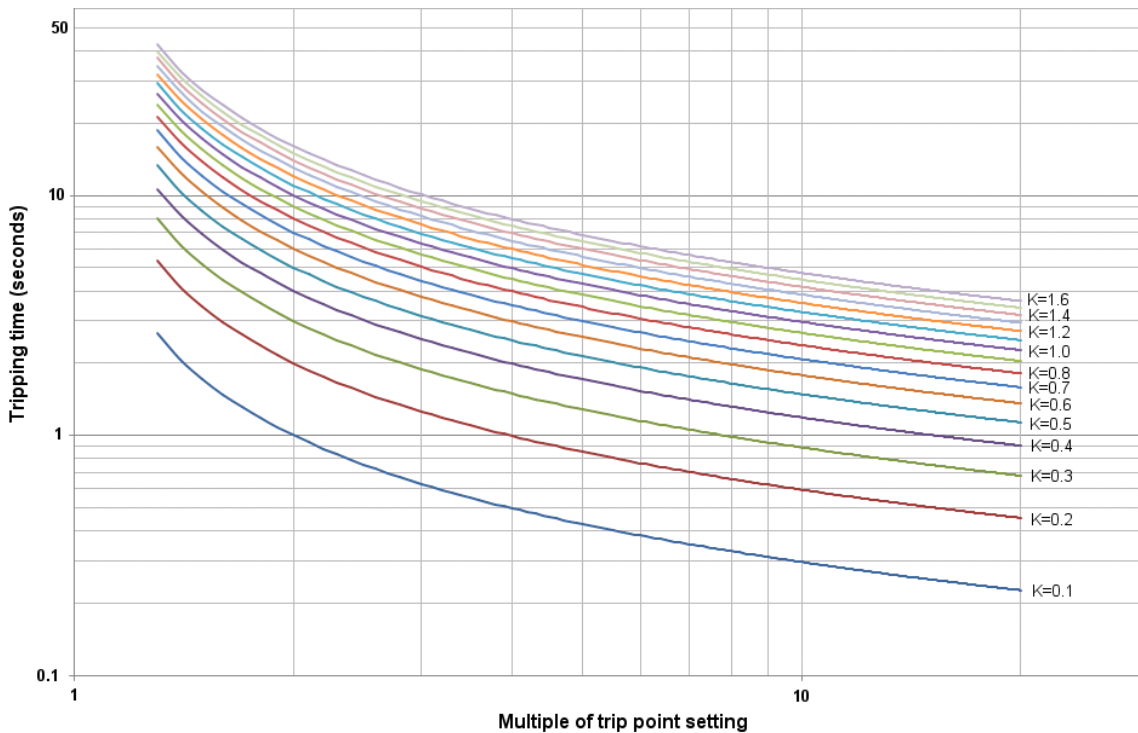

8.10 MAINTENANCE ALARM

Depending upon module configuration one or more levels of maintenance alarm may occur based upon a configurable schedule.

There are three maintenance alarms in the DSE7200/DSE7300 series V3 and above, and one level of maintenance alarm in prior versions.

Example 1

Screen capture from DSE Configuration Suite Software showing the configuration of Maintenance Alarm 1 and Maintenance Alarm 2.

When activated, the maintenance alarm can be either a **warning** (set continues to run) or **shutdown** (running the set is not possible).

Resetting the maintenance alarm is normally actioned by the site service engineer after performing the required maintenance.

The method of reset is either by:

- Activating a input that has been configured to maintenance x reset, where x is the number of the maintenance alarm (1 to 3).
- Pressing the maintenance reset button in the DSE Configuration Suite, Maintenance section.
- Pressing and holding the stop button when the module's display is on the maintenance alarm section. (V9.x.x and above)

The screenshot shows the 'Maintenance Alarm' configuration window. It is divided into two sections: 'Maintenance alarm 1' and 'Maintenance alarm 2'. Each section has the following fields:

- Enable:** A checked checkbox.
- Description:** A text box containing 'Maintenance alarm 1' (for alarm 1) and 'Maintenance alarm 2' (for alarm 2).
- Action:** A dropdown menu set to 'Warning'.
- Engine run hours:** A numeric input field with '10' (for alarm 1) and '250' (for alarm 2) and a slider control.
- Enable alarm on due date:** An unchecked checkbox.
- Maintenance interval:** A numeric input field with '1' and a slider control.

Example 2

Screen capture from DSE Configuration Suite Software showing the configuration of a digital input for Reset Maintenance Alarm 1.

The screenshot shows the 'Digital Input A' configuration window. It has the following fields:

- Function:** A dropdown menu set to 'Reset maintenance alarm 1'.
- Polarity:** A dropdown menu set to 'Close to Activate'.
- Action:** A dropdown menu.
- Arming:** A dropdown menu.
- LCD Display:** A text box.
- Activation Delay:** A slider control set to '0s'.

Example 3

Screen capture from DSE Configuration Suite Software showing the Maintenance Alarm Reset 'button' in the DSE Configuration Suite SCADA | MAINTENANCE section.

The screenshot shows the 'Maintenance Alarm' status display. It displays the following information:

- Running Time Until Next Maintenance: 18 hrs
- Date Of Next Maintenance: 13 Jan 2009
- A 'Reset' button.
- Text below the button: 'Press reset to schedule next maintenance, based upon module's maintenance configuration.'

Example 4

Screen capture from DSE Configuration Suite Software showing the configuration holding stop button to reset the maintenance alarm.

The screenshot shows the 'Miscellaneous Options' configuration window. It has a list of options with checkboxes:

- Enable fast loading feature
- Audible alarm prior to starting
- All warnings are latched
- Enable sleep mode
- Enable manual fuel pump control
- Enable manual frequency trim control
- Support right-to-left languages in module strings
- Enable Alternative Breaker Button Control
- Enable cool down in stop mode
- Enable maintenance reset on module front panel

8.11 SCHEDULER

DSE7000 Series contains an inbuilt exercise run scheduler, capable of automatically starting and stopping the set. Up to 16 scheduled start/stop sequences can be configured to repeat on a 7-day or 28-day cycle. Scheduled runs may be on load or off load depending upon module configuration.

Example

Screen capture from DSE Configuration Suite Software showing the configuration of the Exercise Scheduler.

In this example the set will start at 09:00 on Monday and run for 5 hours, then start at 13:30 on Tuesday and run for 30 minutes.

| Day | Start Time | End Time | Action |
|---------|------------|----------|--------|
| Monday | 09:00 | 05:00 | Clear |
| Tuesday | 13:30 | 00:30 | Clear |
| Monday | 00:00 | 00:00 | Clear |
| Monday | 00:00 | 00:00 | Clear |
| Monday | 00:00 | 00:00 | Clear |
| Monday | 00:00 | 00:00 | Clear |
| Monday | 00:00 | 00:00 | Clear |
| Monday | 00:00 | 00:00 | Clear |
| Monday | 00:00 | 00:00 | Clear |
| Monday | 00:00 | 00:00 | Clear |
| Monday | 00:00 | 00:00 | Clear |
| Monday | 00:00 | 00:00 | Clear |

8.11.1 STOP MODE

- Scheduled runs will not occur when the module is in STOP/RESET mode.

8.11.2 MANUAL MODE

- Scheduled runs will not occur when the module is in MANUAL mode.
- Activation of a Scheduled Run 'On Load' when the module is operating OFF LOAD in Manual mode will have no effect, the set continues to run OFF LOAD

8.11.3 AUTO MODE

- Scheduled runs will operate ONLY if the module is in AUTO mode with no Shutdown or Electrical Trip alarm present.
- If the module is in STOP or MANUAL mode when a scheduled run begins, the engine will not be started. However, if the module is moved into AUTO mode during a scheduled run, the engine will be called to start.
- Depending upon configuration by the system designer, an external input can be used to inhibit a scheduled run.
- If the engine is running OFF LOAD in AUTO mode and a scheduled run configured to 'On Load' begins, the set is placed ON LOAD for the duration of the Schedule.

8.12 FRONT PANEL CONFIGURATION

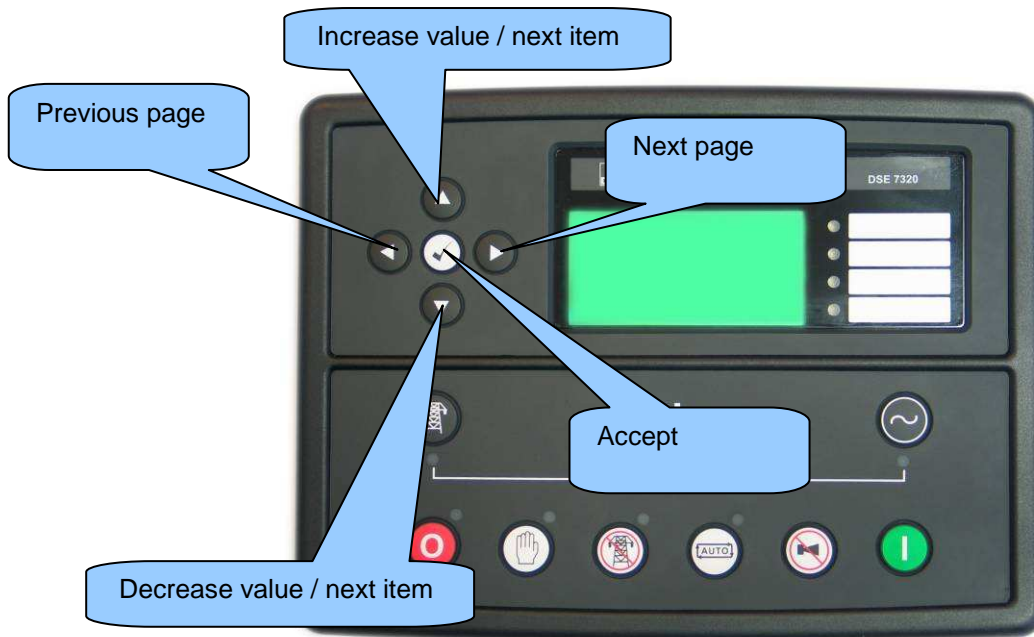

This configuration mode allows the operator limited customising of the way the module operates.

Use the module's navigation buttons to traverse the menu and make value changes to the parameters:



8.13 ACCESSING THE MAIN FRONT PANEL CONFIGURATION EDITOR

Ensure the engine is at rest and the module is in STOP mode by pressing the Stop/Reset  button.

Press the Stop/Reset  and Info  buttons simultaneously.
If a module security PIN has been set, the PIN number request is then shown :

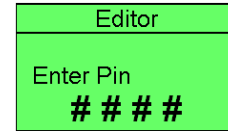

Press , the first '#' changes to '0'. Press  (up or down) to adjust it to the correct value.

Press  (right) when the first digit is correctly entered. The digit you have just entered will now show '#' for security.

Repeat this process for the other digits of the PIN number. You can press  (left) if you need to move back to adjust one of the previous digits.

When  is pressed after editing the final PIN digit, the PIN is checked for validity. If the number is not correct, you must re-enter the PIN.

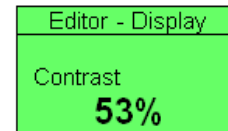

If the PIN has been successfully entered (or the module PIN has not been enabled), the editor is displayed :





NOTE: The PIN number is not set by DSE when the module leaves the factory. If the module has a PIN code set, this has been affected by your generator supplier who should be contacted if you require the code. If the code has been 'lost' or 'forgotten', the module must be returned to the DSE factory to have the module's code removed. A charge will be made for this procedure.
NB - This procedure cannot be performed away from the DSE factory.

8.13.1 EDITING A PARAMETER

Enter the editor as described above.

Press the  (left) or  (right) buttons to cycle to the section you wish to view/change.

Press the  (up or down) buttons to select the parameter you wish to view/change within the currently selected section.

To edit the parameter, press  to enter edit mode. The parameter begins to flash to indicate that you are editing the value.

Press the  (up or down) buttons to change the parameter to the required value.

Press  to save the value. The parameter ceases flashing to indicate that it has been saved.

To exit the editor at any time, press and hold the  button.

▲NOTE: - The editor automatically exits after 5 minutes of inactivity to ensure security.

▲NOTE: - The PIN number is automatically reset when the editor is exited (manually or automatically) to ensure security.

▲ NOTE: - More comprehensive module configuration is possible using the 7xxx series PC configuration software. Please contact us for further details.

8.13.2 ADJUSTABLE PARAMETERS









Front Panel Configuration Editor



= Only available on DSE7220 / DSE7320 AMF Modules

| Section | Parameter as shown on display | Factory Settings | |
|-------------------------------------|-------------------------------------|-------------------------------------|------|
| DISPLAY | Contrast | 53% | |
| | Language | English | |
| | LCD Page Timer | 5m | |
| | Auto Scroll Delay | 2s | |
| | Current Date and time | hh:mm | |
| EDITOR | AIt Config | Default Config | |
| ENGINE | Oil Pressure Low Shutdown | 1.03bar | |
| | Oil Pressure Low Pre Alarm | 1.17bar | |
| | Coolant Temperature Low Warning | 70°C | |
| | Coolant Temperature High Pre Alarm | 90°C | |
| | Coolant Temperature High Shutdown | 95°C | |
| | Remote Start Delay Off Load | 5s | |
| | Remote Start Delay On Load | 5s | |
| | Mains Fail Start Delay | 5s | |
| | Telemetry Start Delay | 5s | |
| | Start Delay Timer | 5s | |
| | Pre Heat Timer | 0s | |
| | Crank Duration Timer | 10s | |
| | Crank Rest Timer | 10s | |
| | Safety On Delay | 10s | |
| | Smoke Limiting | 0s | |
| | Smoke Limiting Off | 0s | |
| | Warm Up Timer | 0s | |
| | Cool Down Timer | 1m | |
| | Engine Under Speed Shutdown | Inactive | |
| | Engine Under Speed Shutdown | 1200RPM | |
| | Engine Under Speed warning | Inactive | |
| | Engine Under Speed warning | 1350RPM | |
| | Engine Over Speed warning | Inactive | |
| | Engine Over Speed warning | 1650RPM | |
| | Engine Over Speed Shutdown | 1710RPM | |
| | Engine Speed Overshoot Delay | 2s | |
| | Engine Speed Overshoot | 0s | |
| | Fail To Stop delay | 30s | |
| | Battery Under Voltage warning | Active | |
| | Battery Under voltage Warning Delay | 1m | |
| | Battery Under Voltage | 10V | |
| | Battery Over Voltage warning | Active | |
| | Battery Over voltage warning Delay | 1m | |
| | Battery Over Voltage warning | 30V | |
| | Charge Alternator Failure warning | Active | |
| | Charge Alternator Failure warning | 6V | |
| | Charge Alternator warning Delay | 5s | |
| | Charge Alternator Failure Shutdown | Active | |
| | Charge Alternator Failure Shutdown | 4.0V | |
| | Charge Alternator Shutdown Delay | 5s | |
| | Drop control | Inactive | |
| | Drop control | 4% (Compatible engine ECUs only) | |
| | Fuel Usage Alarm (Running Rate) | 0%-100% | |
| | Fuel Usage Alarm (Stopped Rate) | 0%-100% | |
| | GENERATOR | Generator Under Voltage Shutdown | 184V |
| | | Generator Under Voltage Pre Alarm | 196V |
| | | Generator Voltage Nominal | 230V |
| Generator Over Voltage Pre Alarm | | 265V | |
| Generator Over Voltage Shutdown | | 277V | |
| Generator Under Frequency Shutdown | | 40Hz | |
| Generator Under Frequency Pre Alarm | | 42Hz | |
| Generator Frequency Nominal | | 50Hz | |
| Generator Over Frequency Pre Alarm | | 55Hz | |
| Generator Over Frequency Shutdown | | 57Hz | |
| Full Load Rating | | 500A | |
| Kw Overload Trip | | 100% | |
| Delayed Over Current | | Active | |
| Delayed Over Current | | 100% | |
| AC System | | 3 Phase, 4 wire | |
| CT Primary | | 600A | |
| CT Secondary | | 5A | |
| Earth CT Primary | | 500A | |
| Earth Fault Trip | | Inactive | |
| Earth Fault Trip | | 10% | |
| Generator transient delay | 0s | | |

Front Panel Configuration Editor (continued)

| Section | Parameter as shown on display | Factory Settings |
|---|--|---|
|  MAINS | Mains Under Voltage Trip | 184V |
| | Mains Over Voltage Trip | 276V |
| | Mains Under Frequency Trip | 45Hz |
| | Mains Over Frequency Trip | 55Hz |
| | Mains Transient Delay | 2s |
| | Return Delay | 30s |
| | Mains Transfer Time | 0.7s |
|  TIMERS | LCD Page Timer | 5m |
| | Auto Scroll Delay | 3s |
| | Pre Heat Timer | 0s |
| | Crank Duration Timer | 0s |
| | Crank Rest Timer | 10s |
| | Safety On Delay | 10s |
| | Smoke Limiting | 10s |
| | Smoke Limiting Off | 0s |
| | warm Up Timer | 0s |
| | Cool Down Timer | 0s |
| | Speed Overshoot Delay | 1m |
| | Fail To Stop Delay | 2s |
| | Battery voltage Low warning Delay | 30s |
| | Battery voltage High warning Delay | 1m |
| | Return Delay | 1m |
| | Generator Transient Delay | 30s |
| |   | Mains Transient Delay |
| Mains Transfer Time | | 2s |
| Schedule | | 0.7s |
|  SCHEDULE | Schedule On Load | Active, Inactive |
| | Schedule Period | Active, Inactive (only available when Scheduler is active) |
| | Schedule time and Date Selection (1-16) | Weekly, Monthly, (only available when Scheduler is active) |
| | Schedule time and Date Selection (1-16) | Press  to begin editing then  or  to select the different parameters in the scheduler. |



8.14 ACCESSING THE 'RUNNING' CONFIGURATION EDITOR

The 'running' editor can be entered while the engine is running. All protections remain active if the engine is running while the running editor is entered.

Press and hold the  button to enter the running editor.

8.14.1 EDITING A PARAMETER

Enter the editor as described above.

Press the  (left) or  (right) buttons to cycle to the section you wish to view/change.

Press the  (up or down) buttons to select the parameter you wish to view/change within the currently selected section.

To edit the parameter, press  to enter edit mode. The parameter begins to flash to indicate that you are editing the value.

Press the  (up or down) buttons to change the parameter to the required value.

Press  to save the value. The parameter ceases flashing to indicate that it has been saved.

To exit the editor at any time, press and hold the  button.

8.14.2 ADJUSTABLE PARAMETERS (RUNNING EDITOR)

Running Editor (Factory default settings are shown in bold italicised text)

| Section | Parameter as shown on display | Factory Setting |
|---------|--|-----------------|
| DISPLAY | Contrast | 50% |
| | Language | English |
| | Engine Speed (If 'manual speed control' is enabled) | |
| | Fuel Pump Control (if 'manual fuel pump control' is enabled) | |

9 COMMISSIONING

9.1.1 PRE-COMMISSIONING

Before the system is started, it is recommended that the following checks are made:-

- 10.1. The unit is adequately cooled and all the wiring to the module is of a standard and rating compatible with the system. Check all mechanical parts are fitted correctly and that all electrical connections (including earths) are sound.
- 10.2. The unit **DC** supply is fused and connected to the battery and that it is of the correct polarity.
- 10.3. The Emergency Stop input is wired to an external **normally closed** switch connected to **DC positive**.

 **NOTE:- If Emergency Stop feature is not required, link this input to the DC Positive. The module will not operate unless either the Emergency Stop is fitted correctly OR terminal 3 is connected to DC positive.**

- 10.4. To check the start cycle operation, take appropriate measures to prevent the engine from starting (disable the operation of the fuel solenoid). After a visual inspection to ensure it is safe to proceed, connect the battery supply. Select **“MANUAL”** and then press **“START”** the unit start sequence will commence.
- 10.5. The starter will engage and operate for the pre-set crank period. After the starter motor has attempted to start the engine for the pre-set number of attempts, the LCD will display 'Failed to start'. Select the **STOP/RESET** position to reset the unit.
- 10.6. Restore the engine to operational status (reconnect the fuel solenoid). Select **“MANUAL”** and then press **“START”**. This time the engine should start and the starter motor should disengage automatically. If not then check that the engine is fully operational (fuel available, etc.) and that the fuel solenoid is operating. The engine should now run up to operating speed. If not, and an alarm is present, check the alarm condition for validity, then check input wiring. The engine should continue to run for an indefinite period. It will be possible at this time to view the engine and alternator parameters - refer to the 'Description of Controls' section of this manual.
- 10.7. Select **“AUTO”** on the front panel, the engine will run for the pre-set cooling down period, then stop. The generator should stay in the standby mode. If not check that there is not a signal present on the **Remote start** input.
- 10.8. Initiate an automatic start by supplying the remote start signal (if configured). The start sequence will commence and the engine will run up to operational speed. Once the generator is available a load transfer will take place (if configured), the Generator will accept the load. If not, check the wiring to the Generator Contactor Coil (*if used*). Check the Warming timer has timed out.
- 10.9. Remove the remote start signal. The return sequence will begin. After the pre-set time, the generator is unloaded. The generator will then run for the pre-set cooling down period, then shutdown into its standby mode.
- 10.10. Set the modules internal clock/calendar to ensure correct operation of the scheduler and event logging functions. For details of this procedure see section entitled *Front Panel Configuration – Editing the date and time*.
- 10.11. If, despite repeated checking of the connections between the **7000** series controller and the customer's system, satisfactory operation cannot be achieved, then the customer is requested to contact the factory for further advice on:-

INTERNATIONAL TEL: +44 (0) 1723 890099

INTERNATIONAL FAX: +44 (0) 1723 893303

E-mail: Support@Deepseapl.com

Website : www.deepseapl.com

10 FAULT FINDING

| SYMPTOM | POSSIBLE REMEDY |
|--|---|
| Unit is inoperative Read/Write configuration does not operate | Check the battery and wiring to the unit. Check the DC supply. Check the DC fuse. |
| Unit shuts down | Check DC supply voltage is not above 35 Volts or below 9 Volts Check the operating temperature is not above 70°C. Check the DC fuse. |
| Unit locks out on Emergency Stop | If no Emergency Stop Switch is fitted, ensure that a DC positive signal is connected to the Emergency Stop input. Check emergency stop switch is functioning correctly. Check Wiring is not open circuit. |
| Intermittent Magnetic Pick-up sensor fault | Ensure that Magnetic pick-up screen only connects to earth at one end, if connected at both ends, this enables the screen to act as an aerial and will pick up random voltages. Check pickup is correct distance from the flywheel teeth. |
| Low oil Pressure fault operates after engine has fired | Check engine oil pressure. Check oil pressure switch/sensor and wiring. Check configured polarity (if applicable) is correct (i.e. Normally Open or Normally Closed) or that sensor is compatible with the 73x0 Module and is correctly configured. |
| High engine temperature fault operates after engine has fired. | Check engine temperature. Check switch/sensor and wiring. Check configured polarity (if applicable) is correct (i.e. Normally Open or Normally Closed) or that sensor is compatible with the 7000 series module. |
| Shutdown fault operates | Check relevant switch and wiring of fault indicated on LCD display. Check configuration of input. |
| Warning fault operates | Check relevant switch and wiring of fault indicated on LCD display. Check configuration of input. |
| Fail to Start is activated after pre-set number of attempts to start | Check wiring of fuel solenoid. Check fuel. Check battery supply. Check battery supply is present on the Fuel output of the module. Check the speed-sensing signal is present on the 7000 series module's inputs. Refer to engine manual. |
| Continuous starting of generator when in AUTO | Check that there is no signal present on the "Remote Start" input. Check configured polarity is correct. Check the mains supply is available and within configured limits (DSE7220/DSE7320 only) |
| Generator fails to start on receipt of Remote Start signal. | Check Start Delay timer has timed out. Check signal is on "Remote Start" input. Confirm correct configuration of input is configured to be used as "Remote Start". Check that the oil pressure switch or sensor is indicating low oil pressure to the controller. Depending upon configuration, then set will not start if oil pressure is not low. |
| Pre-heat inoperative | Check wiring to engine heater plugs. Check battery supply. Check battery supply is present on the Pre-heat output of module. Check pre-heat configuration is correct. |
| Starter motor inoperative | Check wiring to starter solenoid. Check battery supply. Check battery supply is present on the Starter output of module. Ensure that the Emergency Stop input is at Positive. Ensure oil pressure switch or sensor is indicating the "low oil pressure" state to the 7300 series controller. |
| Engine runs but generator will not take load | Check Warm up timer has timed out. Ensure generator load inhibit signal is not present on the module inputs. Check connections to the switching device. Note that the set will not take load in manual mode unless there is an active remote start on load signal. |

| SYMPTOM | POSSIBLE REMEDY |
|--|---|
| <p>Incorrect reading on Engine gauges</p> <p>Fail to stop alarm when engine is at rest</p> | <p>Check engine is operating correctly. Check sensor and wiring paying particular attention to the wiring to terminal 47 (refer to appendix). Check that sensor is compatible with the 7000 series module and that the module configuration is suited to the sensor.</p> |
| <p>Module appears to 'revert' to an earlier configuration</p> | <p>When editing a configuration using the PC software it is vital that the configuration is first 'read' from the controller before editing it. This edited configuration must then be "written" back to the controller for the changes to take effect.</p> <p>When editing a configuration using the fascia editor, be sure to press the Accept  button to save the change before moving to another item or exiting the fascia editor</p> |
| <p>Set will not take load</p> | <p>Ensure the generator available LED is lit</p> <p>Check that the output configuration is correct to drive the load switch device and that all connections are correct.</p> <p>Remember that the set will not take load in manual mode unless a remote start on load input is present or the close generator button is pressed.</p> |
| <p>Inaccurate generator measurements on controller display</p> | <p>Check that the CT primary, CT secondary and VT ratio settings are correct for the application.</p> <p>Check that the CTs are wired correctly with regards to the direction of current flow (p1,p2 and s1,s2) and additionally ensure that CTs are connected to the correct phase (errors will occur if CT1 is connected to phase 2).</p> <p>Remember to consider the power factor. I.e (kW = kVA x powerfactor)</p> <p>The 7000 series controller is true RMS measuring so gives more accurate display when compared with an 'averaging' meter such as an analogue panel meter or some lower specified digital multimeters.</p> <p>Accuracy of the controller is better than 1% of full scale. I.e Gen volts full scale is 333V ph-n so accuracy is $\pm 3.33V$ (1% of 333V).</p> |

 **NOTE:-** The above fault finding is provided as a guide check-list only. As the module can be configured to provide a wide range of different features, always refer to the source of your module configuration if in doubt.

11 MAINTENANCE, SPARES, REPAIR AND SERVICING

The DSE7000 Series controller is designed to be *Fit and Forget*. As such, there are no user serviceable parts within the controller.

In the case of malfunction, you should contact your original equipment supplier (OEM).

11.1 PURCHASING ADDITIONAL CONNECTOR PLUGS FROM DSE







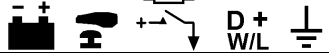

11.1.1 DSE7200 SERIES

If you require additional plugs from DSE, please contact our Sales department using the part numbers below.

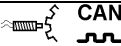
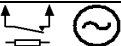
11.1.1.1 PACK OF PLUGS

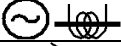
| Module type | Plug Pack Part Number |
|-------------|-----------------------|
| DSE7210 | 057-511 |
| DSE7220 | 007-512 |

11.1.1.2 INDIVIDUAL PLUGS

| 7000 series terminal designation | Plug description | Part No. |
|---|---|----------|
| 1-11  | 11 way 5.08mm | 007-451 |
| 15-18  | 4 way 5.08mm | 007-100 |
| 22-30  | 9 way 5.08mm | 007-167 |
| 39-46  | 8 way 7.62mm | 007-454 |
| 47-50  | 4 way 7.62mm (Not fitted to DSE7210) | 007-171 |
| 51-56  | 6 way 5.08mm | 007-446 |
| 60-65  | 6 way 5.08mm (DSE7200 series only) | 007-379 |
| 60-67  | 8 way 5.08mm (DSE7300 series only) | 007-164 |
|  | PC Configuration interface lead (USB type A – type B) | 016-125 |

NOTE:- Terminal 19 is not fitted to DSE72000 series controllers.

NOTE:- Mains sensing (Terminals 47-50) is not fitted on DSE7210 autostart controller.

NOTE:- RS485 connector is not fitted to the 7200 series controller.







11.1.2 DSE7300 SERIES

If you require additional plugs from DSE, please contact our Sales department using the part numbers below.

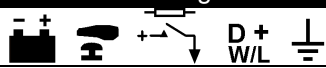
11.1.2.1 PACK OF PLUGS

| Module type | Plug Pack Part Number |
|-------------|-----------------------|
| DSE7310 | 057-513 |
| DSE7320 | 007-514 |

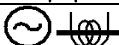
11.1.2.2 INDIVIDUAL PLUGS

| 7000 series terminal designation | Plug description | Part No. |
|---|---|----------|
| 1-11  | 11 way 5.08mm | 007-451 |
| 15-19  | 5 way 5.08mm | 007-445 |
| 22-30  | 9 way 5.08mm | 007-167 |
| 39-46  | 8 way 7.62mm | 007-454 |
| 47-50  | 4 way 7.62mm (Not fitted to DSE7310) | 007-171 |
| 51-56  | 6 way 5.08mm | 007-446 |
| 60-67  | 8 way 5.08mm | 007-164 |
| RS485 | 3 way 5.08mm | 007-174 |
|  | PC Configuration interface lead (USB type A – type B) | 016-125 |

NOTE:- Mains sensing (Terminals 47-50) is not fitted on DSE7310 autostart controller.

11.2 PURCHASING ADDITIONAL FIXING CLIPS FROM DSE

| Item | Description | Part No. |
|--|--|----------|
|  | 7000 series fixing clips (packet of 4) | 020-294 |

11.3 PURCHASING ADDITIONAL SEALING GASKET FROM DSE





| Item | Description | Part No. |
|--|------------------------------------|----------|
|  | 7000 series silicon sealing gasket | 020-507 |

11.4 EXPANSION MODULES

NOTE:- Expansion modules are not compatible with the DSE7200 series controllers.

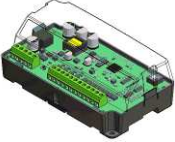
NOTE:- A maximum of twenty (20) expansion modules can be connected to the DSENet®.

NOTE:- DSENet® utilises an RS485 connection. Using Belden 9841 (or equivalent) cable allows for the expansion cable to be extended to a maximum of 1.2km.
DSE Stock and supply Belden 9841 cable. DSE Part Number 016-030.

| Item | Max No. supported | Description | Model order number | DSE Part numbers | | |
|---|-------------------|--|----------------------------|------------------|-----------------|---------------------------|
| | | | | Sales literature | Operator manual | Installation Instructions |
|  | 4 | Model DSE2130 expansion input module provides additional analogue and digital inputs for use with the 73x0 controller. | 2130-001-00 | 055-060 | 057-082 | 053-033 |
|  | 10 | Model DSE2157 expansion relay module provides eight additional voltage free relays for use with the 73x0 controller | 2157-001-00 | 055-061 | 057-083 | 053-034 |
|  | 10 | Model DSE2548 expansion LED module provides additional LED indications, internal sounder and remote lamp test/alarm mute for use with the 73x0 controller. | 2548-001-00 | 055-062 | 057-084 | 053-032 |
|  | 3 | Model DSE2500 Series Expansion Display module provides remote control / display capability for the 7300 series controller. DSE2510 is suitable for DSE7310 controllers DSE2520 is suitable for DSE7320 controllers | 2510-001-00 2520-001-00 | 055-074 | 057-107 | 053-064 |

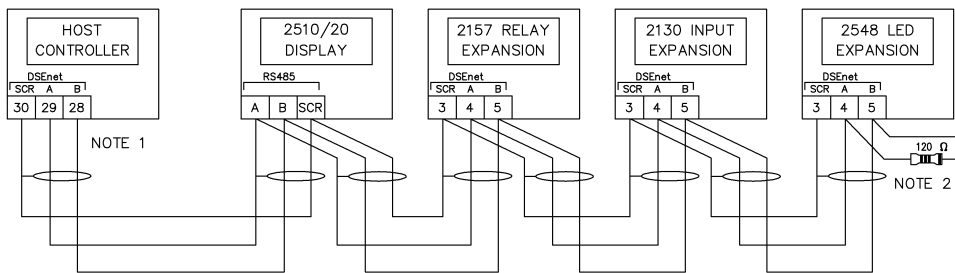



NOTE 1
AS A TERMINATING RESISTOR IS INTERNALLY FITTED TO THE HOST CONTROLLER, THE HOST CONTROLLER MUST BE THE FIRST UNIT ON THE DSEnet

NOTE 2
A 120 OHM TERMINATION RESISTOR MUST BE FITTED TO THE LAST UNIT ON THE DSEnet

11.5 ETHERNET (LAN) CONNECTION

NOTE:- DSE860 and DSE865 cannot be used with the DSE7210 or DSE7220 control modules.

| Item | Description | Model order number | Sales literature | Operator manual | Installation Instructions |
|--|--|--------------------|------------------|-----------------|---------------------------|
|  | Model DSE860 RS232 to Ethernet Adaptor. Enables connection of the DSE7300 series to an Ethernet for monitoring / control / configuration using the DSE Configuration Suite Software. | 0860-001-00 | 055-071 | 057-099 | 053-062 |
|  | Model DSE865 RS485 to Ethernet Adaptor. Enables connection of the DSE7300 series to an Ethernet for monitoring / control / configuration using the DSE Configuration Suite Software. | 0865-001-00 | 055-071 | 057-099 | 053-062 |

12 WARRANTY

DSE provides limited warranty to the equipment purchaser at the point of sale. For full details of any applicable warranty, you are referred to your original equipment supplier (OEM).

13 DISPOSAL

13.1 WEEE (WASTE ELECTRICAL AND ELECTRONIC EQUIPMENT)

Directive 2002/96/EC

If you use electrical and electronic equipment you must store, collect, treat, recycle and dispose of WEEE separately from your other waste.



13.2 ROHS (RESTRICTION OF HAZARDOUS SUBSTANCES)

Directive 2002/95/EC:2006

To remove specified hazardous substances (Lead, Mercury, Hexavalent Chromium, Cadmium, PBB & PBDE's)

Exemption Note: Category 9. (Monitoring & Control Instruments) as defined in Annex 1B of the WEEE directive will be exempt from the RoHS legislation. This was confirmed in the August 2005 UK's Department of Trade and Industry RoHS REGULATIONS Guide (Para 11).

Despite this exemption, DSE has been carefully removing all non RoHS compliant components from our supply chain and products.

When this is completed a Lead Free & RoHS compatible manufacturing process will be phased into DSE production.

This is a process that is almost complete and is being phased through different product groups.