



Enhanced Automatic Gen-Set Transfer Switching Controller for Diesel or Gas Generator with LED Display

EAOM - 210FD

Enhanced Automatic Gen-Set Transfer Switching Controller for Diesel or Gas Generator with LCD Display

EAOM - 210FL

Features

- Protection, control and metering
- Automatic engine start/stop and load transfer
- Automatic shutdown on fault condition
- LED status and fault indication
- Simple push button controlled operation
- Manual, automatic and test mode control
- Six user inputs configurable
- Three resistive sender inputs
- Four user outputs configurable
- Speed sensing from alternator voltage or magnetic pickup
- Exercise at programmed time intervals
- Maintenance warning (working hour or elapsed month)
- Fully programmable
- RS-232 communication port
- Modbus® RTU protocol
- Standard modem communication

Fail Monitoring

- Emergency stop
- Multiple engage fail
- Failed to start
- Low oil pressure
- High temperature
- Speed failure
- Voltage failure
- Charging fail
- Spare-1
- Spare-2
- Spare-3

Error

- Spare-4
- Spare-5
- Spare-6
- Over / under speed
- Speed loss
- Earth fault
- Fuel level
- Battery low
- Battery high
- Maintenance
- Over current
- Short circuit
- Generator stop
- Reverse power

Pre-Alarm

- Generator temperature
- Generator over / under voltage
- Generator over / under frequency
- Oil pressure
- Over / under speed
- Fuel level

Warning

- Reverse power
- Earth fault
- Over current
- Short circuit

Electrical trip

- Reverse power
- Earth fault
- Over current
- Short circuit

Alarm

- Mains breaker not opened
- Mains breaker not closed
- Generator breaker not opened
- Generator breaker not closed

Controls

- Engine fuel supply and engine stopping
- Starter motor
- Automatic generator start
- Load transfer to mains
- Preheat
- External alarm horn

Monitors

- Three phase mains voltages
- Three phase generator voltages
- Three phase current input via internal transformer
- Earth current via internal transformer
- Mains frequency
- Generator frequency
- Battery voltage
- Battery charging voltage
- Generator kVAh
- Generator kWh
- Generator kVA
- Generator kW
- Generator kVAr
- Engine oil pressure
- Fuel level
- Coolant temperature
- Charge generator voltage
- Generator power factor (pf)
- Engine RPM
- Engine running time
- Real time
- Error messages
- Event messages
- Program parameters

The EAOM-210-FD/FL controller unit offers automatic engine starting, stopping, transfer swithing, protection, control and metering of generator sets. In the event of a mains supply failure, the unit automatically transfers the load from the mains to the generator.

Microprocessor technology allows exact measurement, set point adjustment and timing functions with too many parameters to be simply programmed and displayed from the front panel or communicated via RS-232 communications using a PC based software in Modbus RTU protocol. EAOM-210-FD/FL unit can communicate with this software over modem.

Operation

The EAOM-210-FD/FL controller unit provides integrated generator set control, protection, metering and automatic load transfer. If a fault is detected, the engine will automatically shutdown and the failure will be indicated by the LCD display and alarm horn. The unit detects failure of any phase in the mains supply and is able to start the generator and transfer the load. When the mains supply is restored within the pre-set limits, the load is transferred back to the mains supply and the generator is shutdown in a controlled manner. EAOM-210-FD/FL offers manual, fully automatic and test mode which allows the generator to be run without taking the load. Mode of operation can be changed at any time without affecting the operational status of the generator or load connection.

Specifications

Housing & Mounting	144mmx204mmx37mm (including connectors) plastic housing for panel mounting
Protection	IP54 at front panel, IP20 at rear side
Operating / Storage Temperature	0°C to +50°C / -25°C to +70°C
EMC	EN-61000-6-4, EMC generic emission standard for industrial equipment EN-61000-6-2, EMC generic immunity standard for industrial equipment
Electrical Safety	EN-61010-1, safety requirements for electrical equipment for measurement, control and laboratory use
Battery Supply Voltage (---)	8-32 V--- max. Operating current is 360 mA---
Battery Voltage Measurement	8-32V---, accuracy:1% FS, resolution : 0.1V---
Mains Voltage Measurement	Selectable three phase or single phase, 4-wire connection for three phase, 2-wire connection for single phase gen-set 35-300VL-N~ RMS, 15.6-99.9 Hz.Accuracy: 1% FS. Resolution : 1V
Mains Frequency	15.6-99.9 Hz. (Min. 35VL-N~). Accuracy: 0.25%FS. Resolution :0.1Hz
Generator Voltage Measurement	Selectable three phase or single phase, 4-wire connection for three phase, 2-wire connection for single phase gen-set 35-300VL-N~RMS (@15.6-99.9 Hz). Accuracy: 1% FS. Resolution : 1V~
Generator Speed	From magnetic pickup: 35-10000 Hz (4-35 volts peak continuously)Accuracy: 0.25%FS
Cranking Dropouts	Battery voltage can be 0V--- for max. 100msn during cranking (battery voltage should be at least nominal voltage before cranking)
Generator Frequency	From alternator voltage:15.6-99.9 Hz (@35-300VL-N~) Accuracy: 0.25%FS. Resolution: 0.1 Hz
CT Secondary	5A~RMS
Charge Generator Excitation	220mA, max.4W
Communication Interface	RS-232 serial communication
Contact Sensing Inputs	Emergency Stop (NC) Configurable failure inputs-1 (NO or NC selectable) Configurable failure inputs-2 (NO or NC selectable) Configurable failure inputs-3 (NO or NC selectable) Configurable failure inputs-4 (NO or NC selectable) Configurable failure inputs-5 (NO or NC selectable) Configurable failure inputs-6 (NO or NC selectable)
Relay Outputs	Fuel relay output. 12A (@8-32 V---) Start relay output. 12A (@8-32 V---) Horn relay output. 12A (@8-32 V---) Mains open relay output. 5A (@8-32 V---) Mains close relay output. 5A (@8-32 V---) Generator open relay output. 5A (@8-32 V---) Generator close relay output. 5A (@8-32 V---) Configurable relay output-1. 5A (@8-32 V---) Configurable relay output-2. 5A (@8-32 V---) Configurable relay output-3. 5A (@8-32 V---)

LCD Display	<p>128x64 dot-matrix LCD display showing: Mains volts (L1-N, L2-N, L3-N) Mains volts (L1-L2, L2-L3, L3-L1) Mains Hz Generator volts (L1-N, L2-N, L3-N) Generator volts (L1-L2, L2-L3, L3-L1) Generator Hz Engine RPM Generator kVA Generator kW Generator kVAr Generator kVAh Generator kVAh Generator kWh Generator kVAh Generator power factor (pf) Load amps (IL1, IL2, IL3) Earth current (IEA) Engine oil pressure Coolant temperature Fuel level Battery voltage Charge generator voltage Real time Engine running time Next maintenance hour Next maintenance month Event logs Working modes Engine status Error messages Program parameters</p>
Failure Indicators	<p>Engine start High temperature Low oil pressure Over / under speed Generator voltage fail Charge generator fail Over current User configurable input 1 User configurable input 2 User configurable input 3 User configurable input 4 User configurable input 5 User configurable input 6</p>
Status Indicators	<p>Off mode led Test mode led Auto mode led Manual mode led Engine start led Engine stop led Engine running led Mains voltage available led Generator is ready to take the load led Mains contactor led Generator contactor led</p>
Information Alarms	<p>Low battery voltage Emergency stop Maintenance due</p>

Front View



Front View



Front View



EAOM-210- FD

Rear View

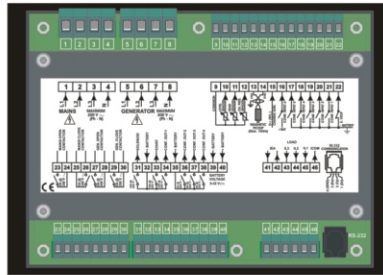

EAOM-210- FD

Front View



EAOM-210- FL

Rear View

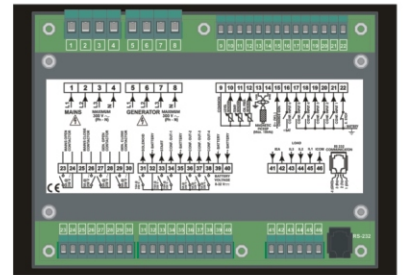

EAOM-210- FL

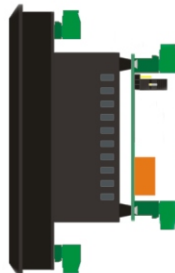
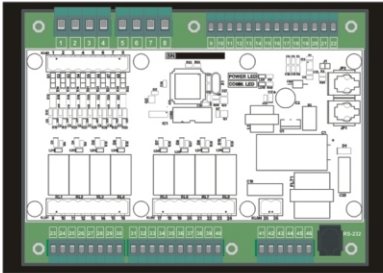

EAOM-210-FL-EX
(Mounted at rear side of EAOM-210-FL with screws)

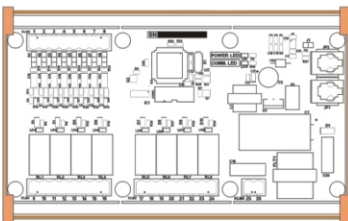

EAOM-210-FL-EXR (DIN RAIL mounting type)

3-phase, 4-wire connections schematic

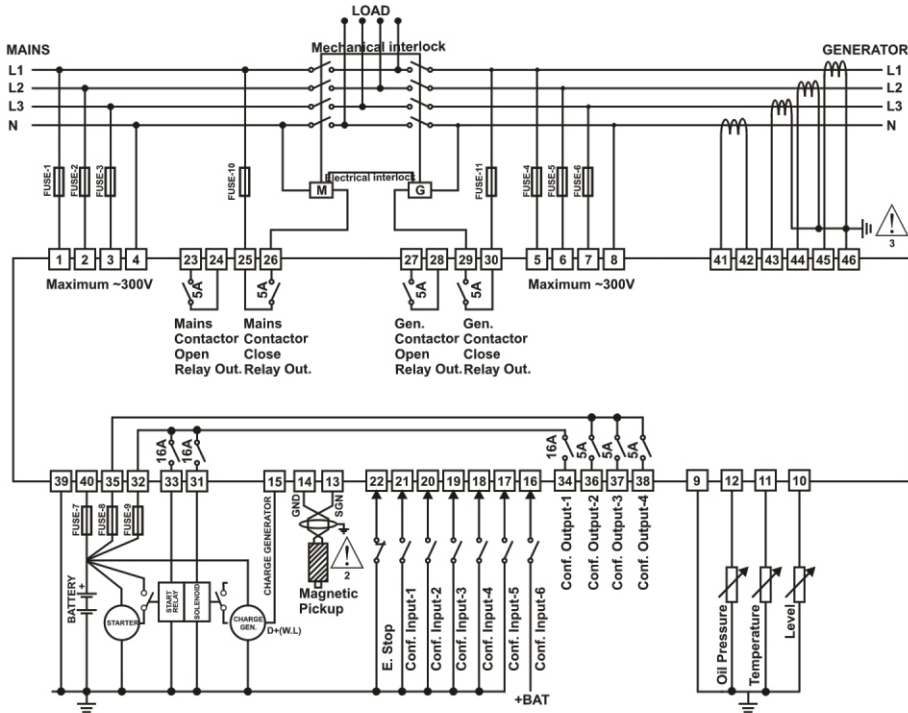

3-phase, 3-wire, delta connections schematic

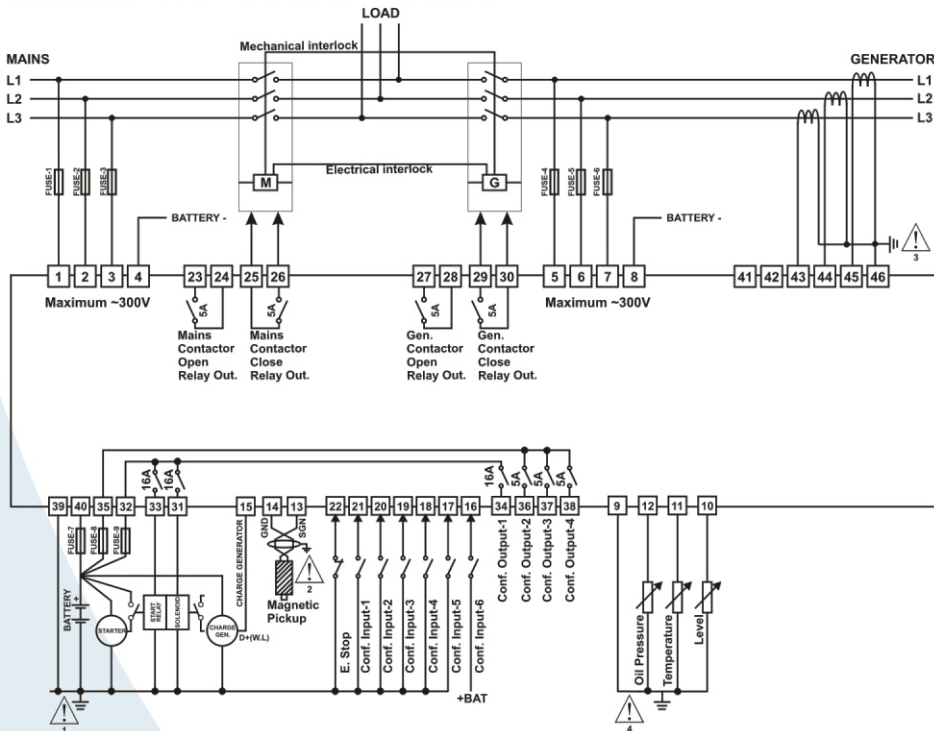

Product Codes

EAOM-210-FD	Enhanced Automatic Gen-Set Transfer Switching Controller w/ Seven Segment LED display, 144x204x37mm Size
EAOM-210-FD-SOFT	PC Communication and Programming Software
EAOM-210-FL	Enhanced Automatic Gen-Set Transfer Switching Controller w/ LCD display, 144x204x37mm Size
EAOM-210-FL-EX	I/O expansion board which is mounted at rear side of EAOM-210-FL w/ screws includes 10 centimeters CanBus Cable.
EAOM-210-FL-EXR	I/O expansion board which is DIN RAIL mounting type includes 2 meters CanBus cable.
EAOM-210-FL-SOFT	PC Communication and Programming Software