

EAOM-9F & EAOM-9F ND Automatic Transfer Switch Controllers, Flat Type

- Protection, control and metering
 - Automatic engine start/stop and load transfer
 - Automatic shutdown on fault condition
 - LED status and fault indication
 - Simple push-button controlled operation
 - Manual, automatic and test mode control
 - Two user-configurable inputs
 - One user-configurable output
 - Fully programmable
 - RS-232 communication port
 - Standard modem communication
-
- Monitors (Only EAOM-9F)
 - 3-phase mains supply voltage
 - Alternator voltage
 - Alternator frequency
 - Engine Speed
 - Controls
 - Engine fuel supply or Engine Stopping
 - Starter motor
 - Alarm horn
 - Preheat
 - Automatic generator start
 - Fail Monitoring
 - Mains Supply Voltage
 - Alternator Voltage and Frequency
 - Engine Speed
 - Engine Temperature
 - Oil Pressure
 - Charge Generator Voltage
-
- Battery voltage
 - Engine running time
 - Error Indication
 - Program Parameters
-
- Load transfer on mains failure
 - Return to mains
 - Mains contactor
 - Generator contactor
-
- Engine Start
 - Alternator Over Current
 - Emergency Stop
 - Maintenance Due
 - Low Battery Voltage
-
- Programming using the buttons and display on the front panel or RS-232 communication port, using PC based software.

ABOUT INSTRUCTION MANUAL

Instruction manual of EAOM-9F & EAOM-9F ND consists of two main sections. Explanation of these sections are below. Also, there is another section which include technical specifications of the device. All titles and page numbers in instruction manual are in “**CONTENTS**” section. User can reach to any title with section number.

Installation:

In this section, physical dimensions of the device, panel mounting, electrical wiring, physical and electrical installation of the device to the system are explained.

Operation and Parameters:

In this section, user interface of the device, how to access to the parameters, description of the parameters are explained.

Also in these sections, there are warnings to prevent serious injury while doing the physical and electrical mounting or using the device.

Explanation of the symbols which are used in these sections are given below.



This symbol is used for safety warnings. User must pay attention to these warnings.



This symbol is used to determine the dangerous situations as a result of an electric shock. User must pay attention to these warnings definitely.



This symbol is used to determine the important notes about functions and usage of the device.



This symbol is used for VDC



This symbol is used for VAC

CONTENTS

1.PREFACE.....	Page 6
1.1 GENERAL SPECIFICATIONS	
1.2 WARRANTY	
1.3 MAINTENANCE	
2.INSTALLATION.....	Page 9
2.1 GENERAL DESCRIPTION	
2.2 DIMENSIONS	
2.3 PANEL CUT-OUT	
2.4 ENVIRONMENTAL RATINGS	
2.5 PANEL MOUNTING	
2.6 INSTALLATION FIXING SCREWS	
2.7 REMOVING FROM THE PANEL	
3.ELECTRICAL WIRINGS.....	Page 14
3.1 TERMINAL LAYOUT AND CONNECTION INSTRUCTIONS	
3.2 ELECTRICAL WIRING DIAGRAM	
4.RS-232 SERIAL INTERFACE, PROGRAMMING THE DEVICE OVER PC OR MODEM.....	Page 18
4.1 CABLE CONNECTION BETWEEN RS-232 TERMINAL OF THE DEVICE AND PC	
4.2 CABLE CONNECTION BETWEEN RS-232 TERMINAL OF THE DEVICE AND MODEM	
4.3 PC INTERFACE	
4.3.1 TECHNICAL SPECIFICATIONS	
4.3.2 INSTALLATION INSTRUCTIONS	
4.3.2.1 MINIMUM SYSTEM REQUIREMENTS	
4.3.3 INSTALLING EAOM-9F / EAOM-9F ND SOFTWARE	
4.3.4 USING OF EAOM-9F / EAOM-9F ND COMMUNICATION SOFTWARE	
4.3.5 DESCRIPTION	
4.3.6 OBSERVATION WINDOW	
4.3.7 OPERATOR PARAMETERS WINDOW	
4.3.8 TECHNICIAN PARAMETERS WINDOW	
4.3.9 MAIN MENU	
4.3.9.1 FILE	
4.3.9.2 PROGRAMMING	
4.3.9.3 SETTINGS	
4.3.10 ENTERING TO THE OPERATOR PARAMETERS WINDOW	
4.3.11 ENTERING TO THE TECHNICIAN PARAMETERS WINDOW	
4.3.12 ENTERING TO THE ADJUSTMENT WINDOW	
4.3.13 LOAD THE CONFIGURATION FILE FROM DISC	
4.3.14 SAVE THE CONFIGURATION FILE TO THE DISC	
4.3.15 UPLOAD	
4.3.16 DOWNLOAD	
5.PARAMETERS.....	Page 26
5.1. PROGRAM FUNCTIONS	
5.1.1 MAINS VOLTAGE	
5.1.2 ALTERNATOR VOLTAGE	
5.1.3 ALTERNATOR FREQUENCY	
5.1.4 ENGINE COOLING TIME	
5.1.5 BATTERY VOLTAGE LOWER LIMIT	
5.1.6 ENGINE STARTING	
5.1.7 ENGINE STARTED SIGNALS	
5.1.8 SPEED SENSING INPUT SELECTION	
5.1.9 STOP / FUEL SOLENOID SELECTION	
5.1.10 STOP MAGNET ENERGISING TIME	
5.1.11 OIL PRESSURE BY-PASS TIME	
5.1.12 CONTROL ON DELAY	
5.1.13 CONFIGURABLE INPUTS	
5.1.14 "POWER ON" DEFAULT MODE CONFIGURATION	
5.1.15 CONFIGURABLE OUTPUT	
5.1.16 MAINTENANCE INDICATION	
5.1.17 OPERATOR PASSWORD	
5.1.18 TECHNICIAN PASSWORD	
5.1.19 ENGINE EXERCISE FUNCTION	
5.1.20 MAINS CONTACTOR CONTROL SELECTION	

- 5.1.21 HORN BLINK SELECTION
- 5.1.22 ENGINE STARTING DELAY
- 5.1.23 ENGINE FUEL SELECTION AND FUEL-STARTER DELAY TIME
- 5.1.24 REMOTE CONTROL MODE SELECTION
- 5.2 CHANGING and SAVING OPERATOR PARAMETER VALUE
- 5.3 CHANGING and SAVING TECHNICIAN PARAMETER VALUE

6. COMMISSIONING	Page	39
6.1 MANUAL OPERATION		
6.2 AUTO OPERATION		
6.3 TEST MODE OPERATION		
7. LAMP TEST	Page	40
8. OPERATION	Page	41
8.1 FRONT PANEL DESCRIPTION		
8.2 DISPLAY MODE INDICATORS		
8.3 MODE TRANSITION		
8.4 MANUAL START		
8.5 MANUAL STOP		
8.6 AUTO OPERATION		
8.7 TEST OPERATION		
8.8 ENGINE EXERCISING		
9. FAULT FINDING	Page	44
9.1 FAULT INDICATIONS		
9.1.1 FAILED TO START LED		
9.1.2 HIGH TEMPERATURE LED		
9.1.3 LOW OIL PRESSURE LED		
9.1.4 CHARGE GENERATOR FAILURE LED		
9.1.5 OVER SPEED LED		
9.1.6 GENERATOR VOLTAGE FAILURE LED		
9.1.7 OVER CURRENT LED		
9.1.8 CONFIGURABLE INPUT-1 AND 2 LED		
9.1.9 EMERGENCY STOP MESSAGE LED		
9.1.10 LOW BATTERY VOLTAGE MESSAGE LED		
9.1.11 MAINTENANCE TIME MESSAGE LED		
10. PROGRAMMABLE PARAMETERS	Page	47
11. SPECIFICATIONS	Page	49

EU DECLARATION OF CONFORMITY

Manufacturer Company Name : Emko Elektronik A.S.

Manufacturer Company Address: DOSAB, Karanfil Sokak, No:6, 16369 Bursa, Turkiye

The manufacturer hereby declares that the product conforms to the following standards and conditions.

Product Name : Electrical control equipment for generating sets

Model Number : EAOM-9F & EAOM-9F ND

Type Number : EAOM-9F & EAOM-9F ND

Product Category : Electrical equipment for measurement, control and laboratory use

Conforms to the following directives :

EMC : BS EN 50081-2, EMC Generic Emission Standard for industrial equipment
BS EN 50082-2, EMC Generic Immunity Standard for industrial equipment

Electrical Safety : EN 61010-1, Safety Requirements for electrical equipment for measurement, control and laboratory use

1. PREFACE

The EAOM-9F / EAOM-9F ND provides for automatic transfer of a load from mains to generator in the event of a mains supply failure. Intended for unattended operation, it is able to detect failure of any phase of the mains and to start and switch over to a generator if the mains voltage goes outside pre-set limits. Both automatic and manual control is possible. A test mode is also available which allows the generator to be run without taking the load.

The unit monitors generator operation and gives warning of any faults that are detected, by LED indicators. The unit monitors:

Mains supply voltage	Engine Start
Alternator voltage and frequency	Alternator Over Current
Engine temperature	Emergency Stop
Oil Pressure	Maintenance Due
Charge generator voltage	Low Battery Voltage
Engine speed	

It controls:

Engine fuel supply or engine stopping	Mains and Generator contactors
Starter motor	Preheat
Alarm horn	Automatic generator start
Automatic generator start and load transfer on mains failure	Return to mains

EAOM-9F Features a four-digit, seven-segment LED display, providing extensive monitoring of unit and generator parameters, including:

- Three phase mains voltage
- Alternator output voltage and frequency
- Engine RPM
- Battery voltage
- Elapsed time
- Error indication
- Engine running time
- Program Parameters

EAOM-9F ND has no display, offers identical functionality and programming via RS-232, and can be used where electrical and engine metering is already in place.

The unit is extensively programmable through the front panel, with password protection on two levels. Operational parameters can also be monitored and controlled from a PC via a built-in RS-232 port.

If the engine fails to start on the first attempt, further attempts are made up to a programmed number of times or until successful.

If a fault is detected, the unit shuts down the engine and indicates the failure by flashing a relevant fault LED.

Emergency stop and remote inhibit inputs provide for remote control of the engine. Configurable inputs can be programmed to perform many functions, such as warning alarms, stopping the engine or disconnecting the load.

A configurable output can be programmed for various functions, including alarms, operation as a pre-heat output, indication of engine running status, and indication that the product is in Automatic mode.

The unit can be programmed using the buttons and display on the front panel. Refer to Section 5 Parameters for details. Alternatively, the unit can be programmed via the RS-232 communication port, using PC based software. EAOM-9F/ EAOM-9F ND can communicate with this software over modem.

1.1 General Specifications

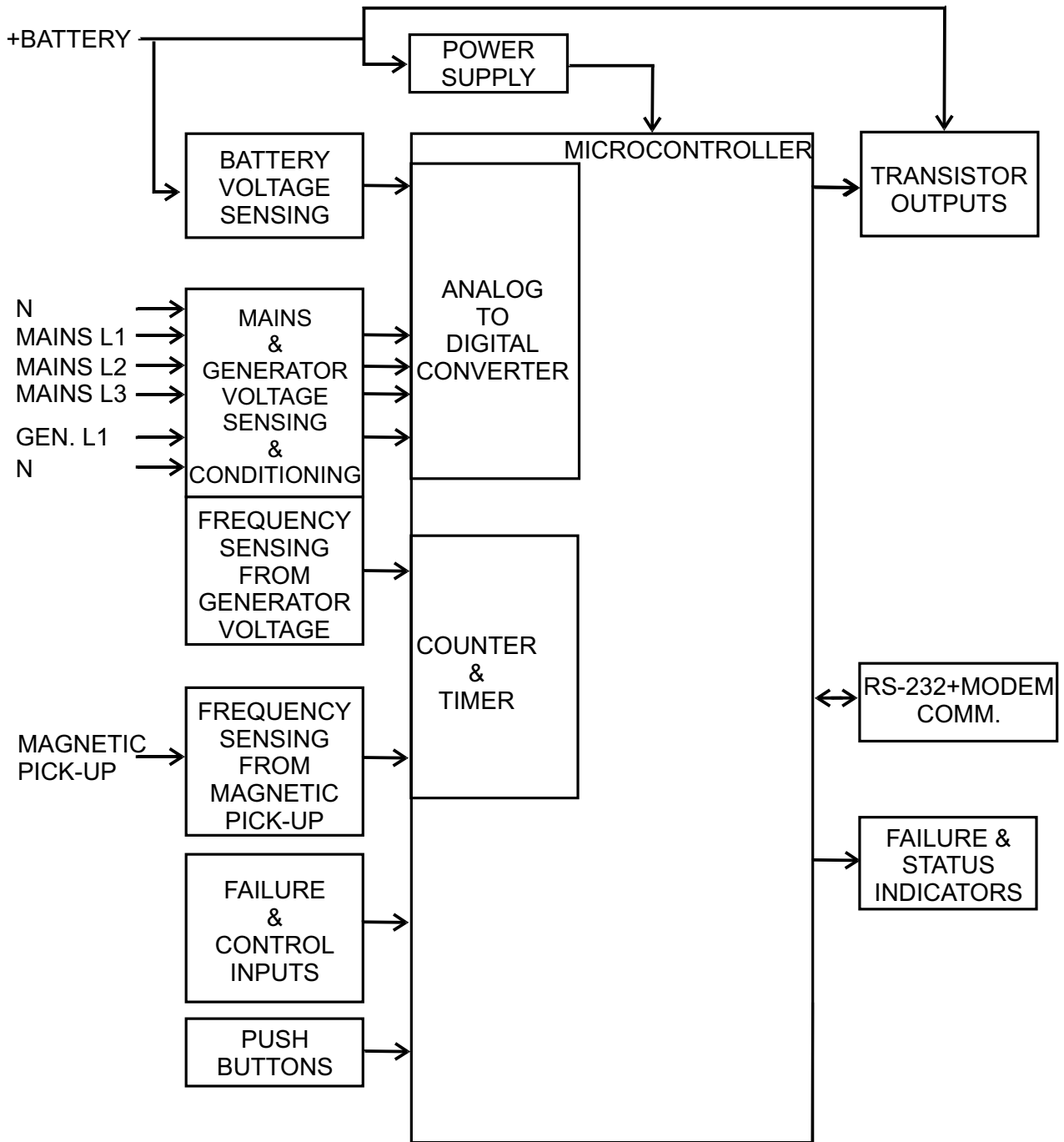

1.2 Warranty

EMKO Elektronik warrants that the equipment delivered is free from defects in material and workmanship. This warranty is provided for a period of two years. The warranty period starts from the delivery date. This warranty is in force if duty and responsibilities which are determined in warranty document and instruction manual performs by the customer completely.

1.3 Maintenance

Repairs should only be performed by trained and specialized personnel. Cut power to the device before accessing internal parts.

Do not clean the case with hydrocarbon-based solvents (Petrol, Trichlorethylene etc.). Use of these solvents can reduce the mechanical reliability of the device. Use a cloth dampened in ethyl alcohol or water to clean the external plastic case.

2. INSTALLATION



Before beginning installation of this product, please read the instruction manual and warnings below carefully.

Carefully unpack the unit and check for damage to the unit or to the cables supplied. Retain the packing in case of future need, e.g. returning the unit for calibration.

Check the contents, as follows:

- One EAOM-9F / EAOM-9F ND unit.
- Operating Manual.
- Screw fixings.
- RS-232 Cable.

Before commencing installation:

- Disconnect all electrical power to the machine.
- Make sure the machine cannot operate during installation.
- Follow all of the machine manufacturers' safety warnings.
- Read and follow all installation instructions.

A visual inspection of this product for possible damage occurred during shipment is recommended before installation. It is your responsibility to ensure that qualified mechanical and electrical technicians install this product.

Be sure to use the rated power supply voltage to protect the unit against damage and to prevent failure.

Keep the power off until all of the wiring is completed so that electric shock and trouble with the unit can be prevented.

Never attempt to disassemble, modify or repair this unit. Tampering with the unit may result in malfunction, electric shock or fire.

Do not use the unit in combustible or explosive gaseous atmospheres.

During the equipment is putted in hole on the metal panel while mechanical installation some metal burrs can cause injury on hands, you must be careful.

Montage of the product on a system must be done with it's own fixing screws. Do not do the montage of the device with inappropriate fixing screws. Be sure that device will not fall while doing the montage.

It is your responsibility if this equipment is used in a manner not specified in this instruction manual.

Report any shortage or damage to your local sales office as soon as possible.

2.1 General Description

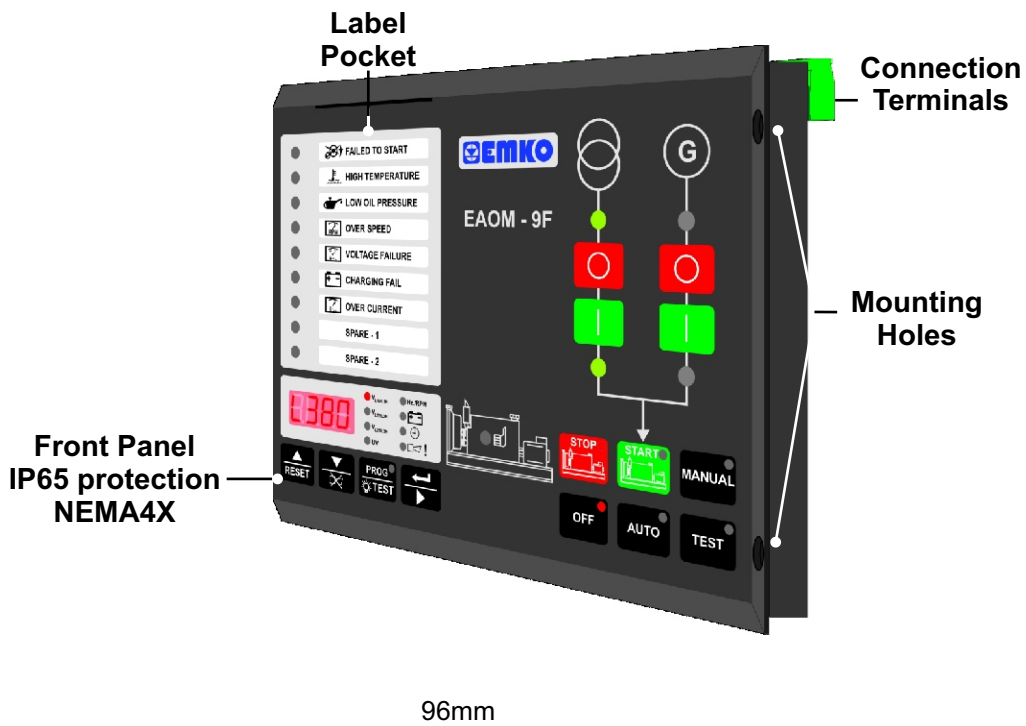

2.2 Dimensions

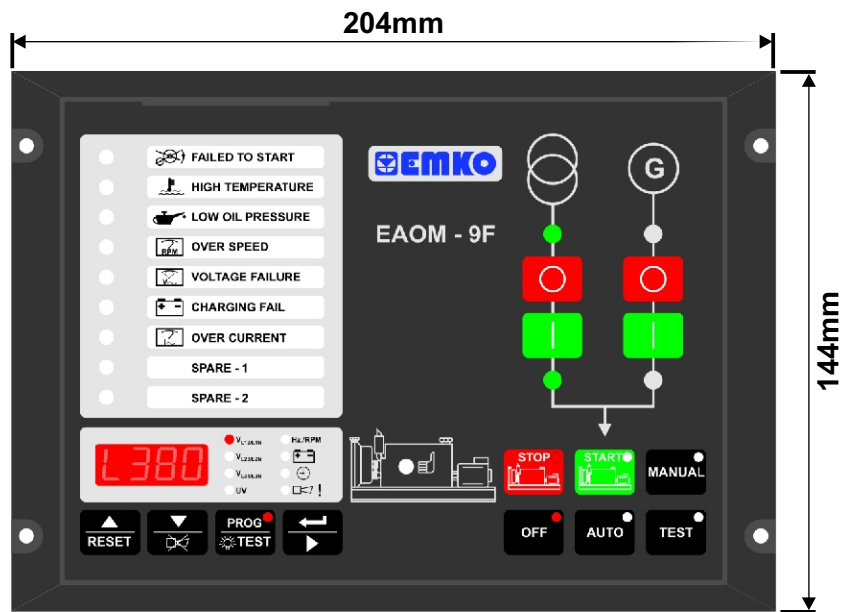
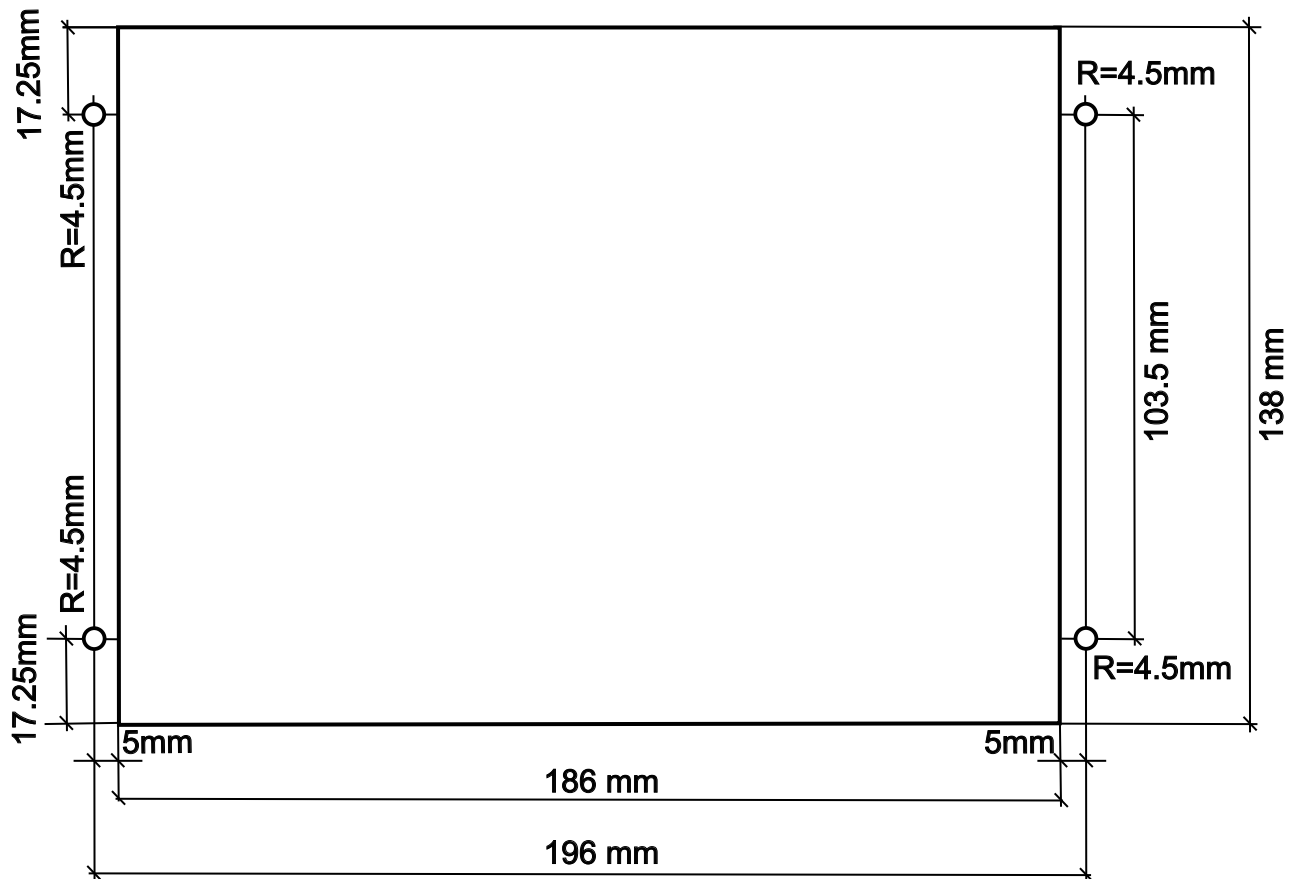

Figure 2.1. Front View



Şekil 2.2. Side View

2.3 Panel Cut-Out



2.4 Environmental Ratings

Operating Conditions



Operating Temperature : -25°C to 70°C



Max. Operating Humidity : 90% Rh (non-condensing)



Altitude : Up to 2000m.



Forbidden Conditions:
Corrosive atmosphere
Explosive atmosphere
Home applications (The unit is only for industrial applications)

2.5 Panel Mounting

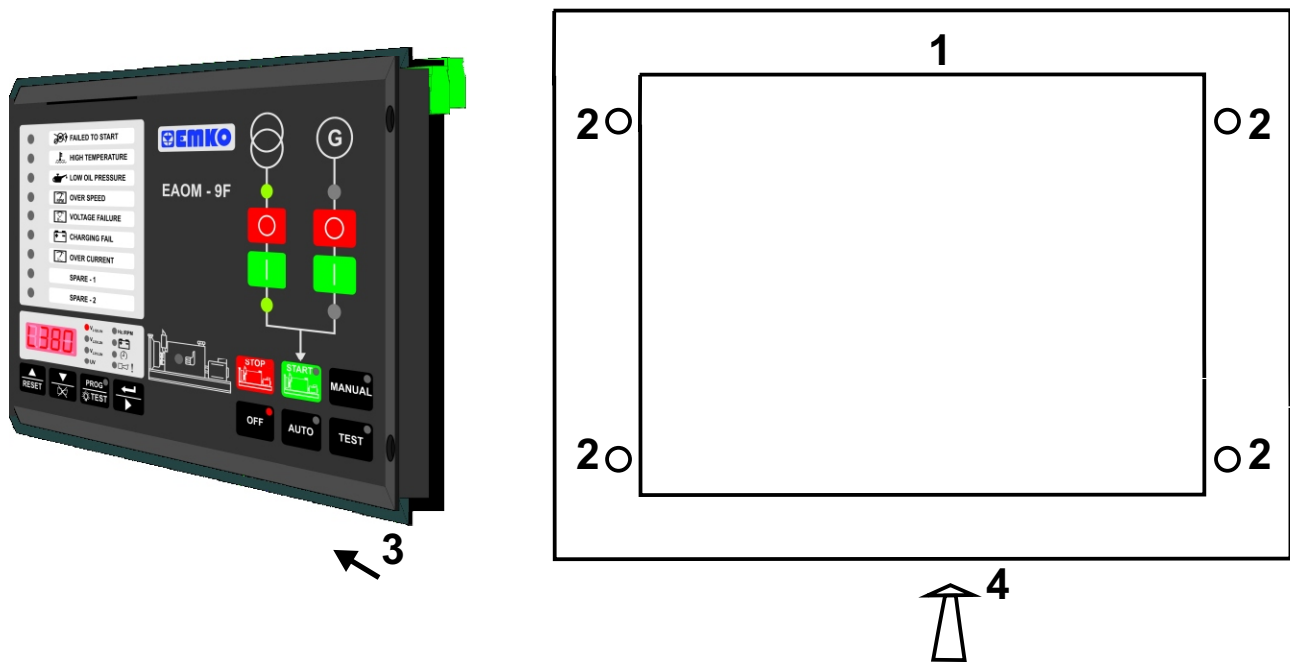

1. Before mounting the device in your panel, make sure that the cut-out is of the right size
2. Make sure that the diameter of the holes are of the right size and coordinate of the holes are true.
3. Check front panel gasket position
4. Insert the device through the cut-out. If the mounting screws are on the unit, put out them before inserting the unit to the panel.



During installation into a metal panel, care should be taken to avoid injury from metal burrs which might be present. The equipment can loosen from vibration and become dislodged if installation parts are not properly tightened. These precautions for the safety of the person who does the panel mounting.

2.6 Installation Fixing Screws

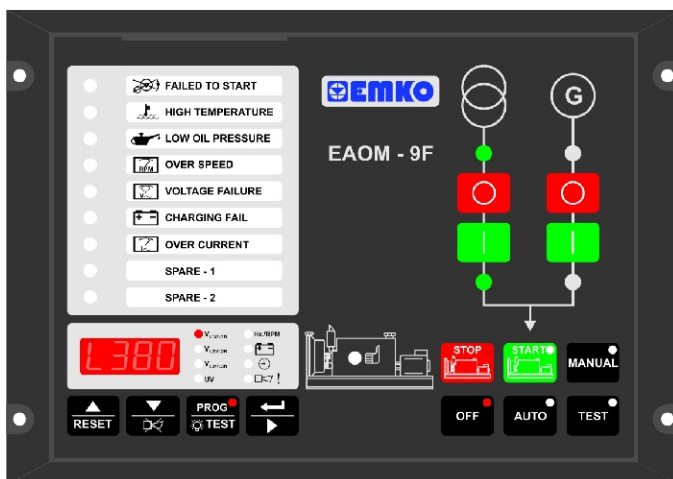

The unit is designed for panel mounting. Fixing is done by four screw fixings

1. Insert the unit in the panel cut-out from the front side.
2. Insert the fixings through the mounting holes and tighten the fixing screws to secure the unit against the panel.



During mechanical installation, beware of any sharp burrs on the metal panel aperture. Ensure that the fixings are properly tightened to prevent the fixings becoming loose due to panel vibration.

Montage of the unit to a system must be done with it's own fixing screws. Do not do the montage of the device with inappropriate fixing screws. Be sure that device will not fall while doing the montage.

2.7 Removing from the Panel



Before starting to remove the unit from panel, power off the unit and the related system.

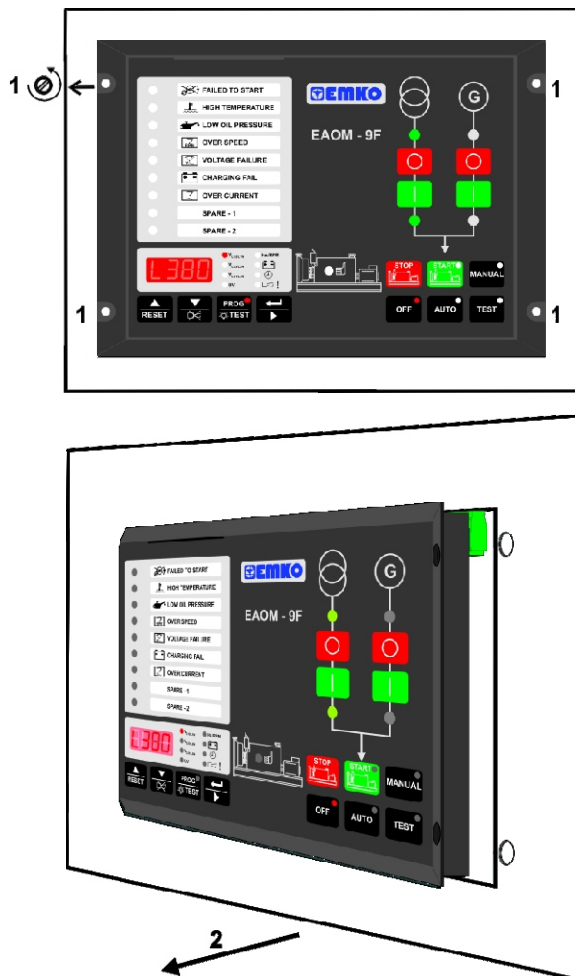

1. Loosen the screws.
2. Pull the unit through the front side of the panel

3. ELECTRICAL WIRINGS

3.1 Terminal Layout and Connection Instructions

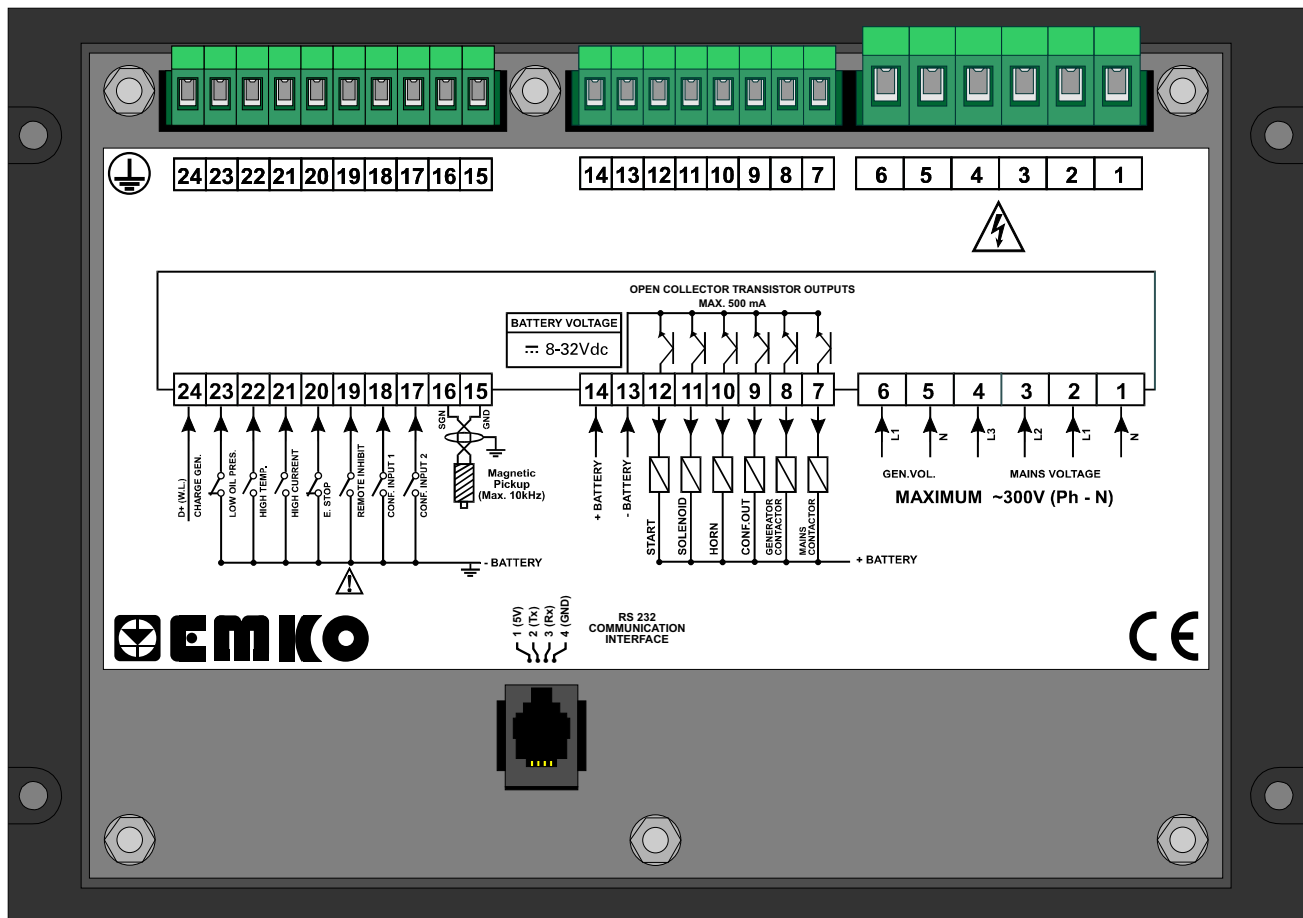

Only qualified personnel and trained technicians should work on this equipment. This equipment contains internal circuits with voltage dangerous to human life. Do not open or dismantle the product enclosure.

The Remote Inhibit input is only active when the unit is in the AUTO Mode. When asserted, the engine will not start up. If the engine was already running when this input becomes active, the engine will shut down. The generator operates normally when the input is open circuit.

While installing the unit, battery voltage range must be controlled and appropriate battery voltage must be applied to the unit. Controlling prevents damages in unit and system and possible accidents as a result of incorrect battery voltage.

Switch on the battery voltage only after that all the electrical connections have been completed.

External fuse is recommended.

In case of failure it is suggested to return the instrument to the manufacturer for repair.

You must ensure that the device is correctly configured for your application. Incorrect configuration could result in damage to the process being controlled, and/or personal injury. It is your responsibility, as the installer, to ensure that the configuration is correct. Device parameters has factory default values. These parameters must be set according to the system's needs. There is severe danger for human life in the case of unauthorized intervention.

3.2 Electrical Wiring Diagram

Single Phase Electrical Wiring

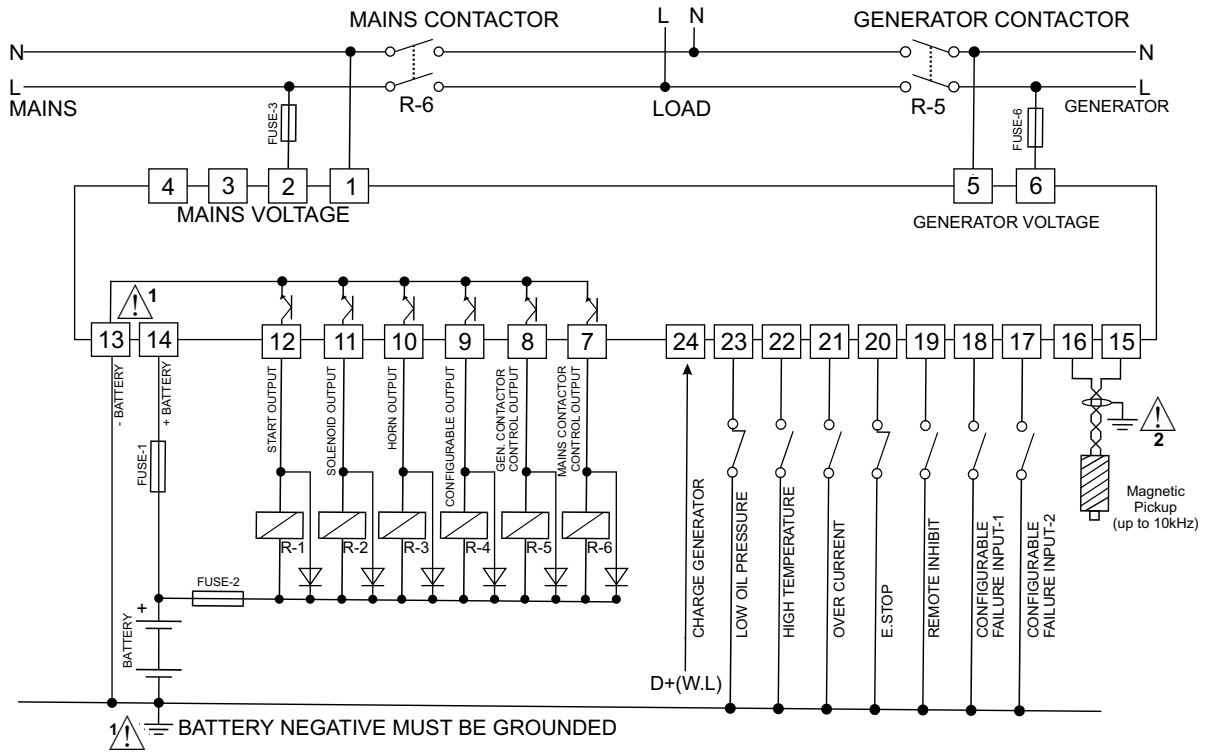

Three Phase Electrical Wiring

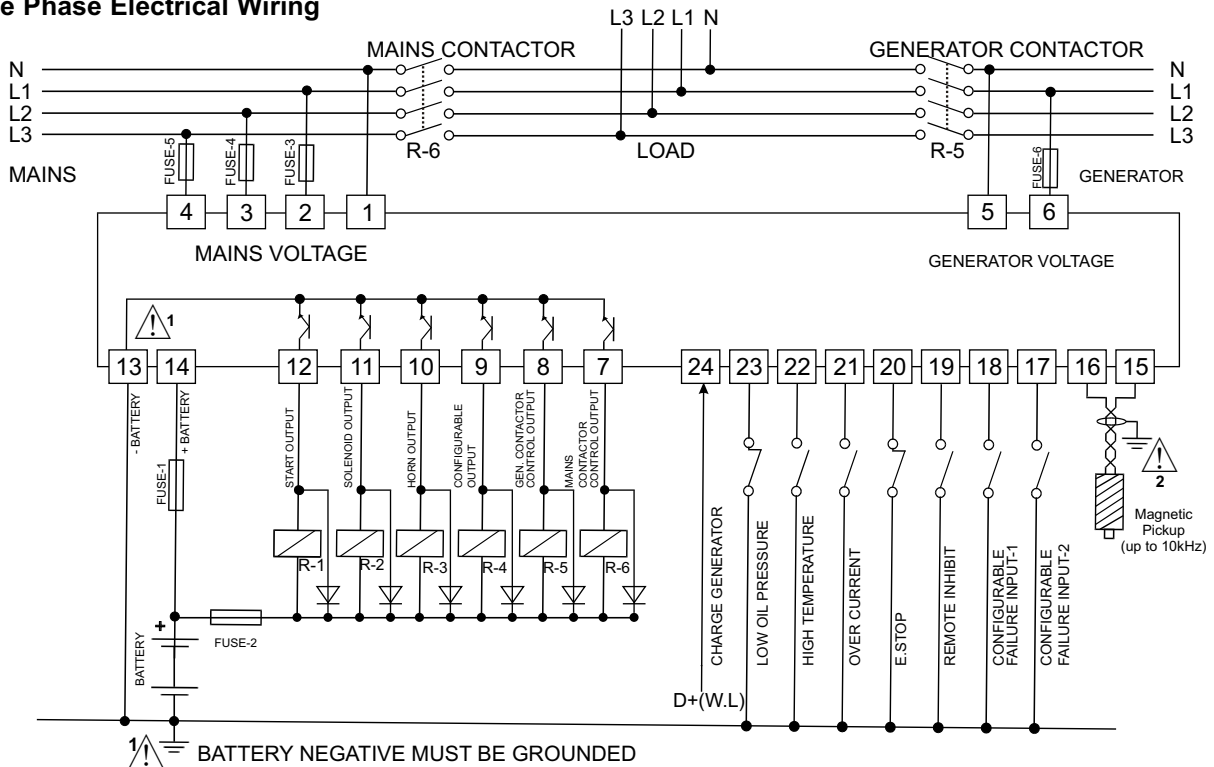

Ensure the battery supply is of the correct polarity and that the battery negative rail is grounded. The connectors can be unplugged from the rear of the unit for convenience and to speed up installation.

The fuses should be as follows:

- FUSE-1, FUSE 3, FUSE-4, FUSE-5, FUSE-6 1 A. T
- FUSE-2 2A. T



- 1- Connect the unit as shown in the appropriate diagram above. Be sure to connect the battery supply the right way round and battery negative should be grounded. The connectors can be unplugged from the rear of the unit to facilitate connection.
- 2- Screened cable must be used for connecting the Magnetic Pickup, ensuring that the screen is grounded at one end ONLY.

Table 2.1 shows the connections and recommended cable sizes. Table 2.2 describes the functions of the connections.

Table 2.1 Unit wiring

Pin	Description	Cable Size (mm)	Notes
1	Mains PEN conductor	2.5	
2	Mains voltage input (L1)	2.5	
3	Mains voltage input (L2)	2.5	3 phase applications only
4	Mains voltage input (L3)	2.5	3 phase applications only
5	Alternator PEN conductor	2.5	
6	Alternator voltage input (L1)	2.5	
7	Output to mains contactor (via external relay) transistor output.	1	500 mA _{DC}
8	Output to generator contactor (via external relay) transistor output.	1	500 mA _{DC}
9	Configurable output (via external Relay) transistor output.	1	500 mA _{DC}
10	Output to horn (via external relay) transistor output.	1	500 mA _{DC}
11	Output to fuel / stop solenoid (via external relay) transistor output.	1	500 mA _{DC}
12	Output to start (via external relay) transistor output.	1	500 mA _{DC}
13	-Battery supply to EAOM-9F/EAOM-9F ND and transistor outputs common	2.5	Supplies to unit.
14	+Battery supply to EAOM-9F/-9F ND	2.5	Supplies to unit
15 16	Input from magnetic pick-up	1	
17	Configurable failure input-2	1	Switch to 0 V _{DC} (NO)
18	Configurable failure input-1	1	Switch to 0 V _{DC} (NO)
19	Input from remote inhibit	1	Switch to 0 V _{DC} (NO)
20	Input from emergency stop	1	Switch to 0 V _{DC} (NC)
21	Input from high current	1	Switch to 0 V _{DC} (NO)
22	Input from high temperature	1	Switch to 0 V _{DC} (NO)
23	Input form low oil pressure	1	Switch to 0 V _{DC} (NC)
24	Input from charge generator	1	

Table 2.2 Unit wiring description

Pin	Function
1	Mains PEN conductor EAOM-9F / EAOM-9F ND
2	L1 Mains voltage inputs. Used to detect failure for controlling automatic transfer of load to alternator. Pins 3 and 4 not used on single phase L3 Applications.
3	
4	
5	Alternator PEN conductor to EAOM-9F.
6	Input from alternator L1 phase. Unit can be programmed to use frequency of alternator output to detect when engine has started.
7	Mains contactor transistor output. For mains contactor normally closed or normally open can be selected. (via external relay)
8	Alternator contactor transistor output (via external relay)
9	Configurable failure output. Can be programmed to provide transistor output closure when : alarm occurs, engine is running, unit is ready for automatic operation or preheat function. (Via external relay)
10	Horn transistor output. Alarm output. (via external relay)
11	Fuel / Stop transistor output. Controls fuel to engine or control engine stopping (via external relay)
12	Start transistor output. Controls starter motor. (via external relay)
13	- Battery input supplies EAOM-9F.
14	+ Battery input supplies EAOM-9F.
15	Input from magnetic pick-up. Unit can be programmed for number of teeth detected on Flywheel.
16	
17	Configurable failure input-2. If the configurable input is normal, contact closure to input active, if the configurable input is fail safe, contact open to input active. If the input is active, it can be programmed to sound the horn, flash the annunciator lamp, stop the engine or de-energise the generator contactor control transistor output.
18	Configurable failure input-1. If the configurable input is normal, contact closure to input active, if the configurable input is fail safe, contact open to input active. If the input is active, it can be programmed to sound the horn, flash the annunciator lamp, stop the engine or de-energise the generator contactor control transistor output.
19	Input from remote inhibit switch. Normally open contact. Active when the unit is in the AUTO mode. The engine will not start, when contact is closed, if asserted while the engine is running, engine will shut down. Generator keeps on running normally when the contact is opened.
20	Emergency stop input. Normally closed. When switch is opened, engine will stop.
21	Over current input. If the configurable input is normal, contact closure to input active. If the configurable input is fail safe, contact open to input active. Closed on over current. On over current, the unit de-energise generator to remove load. Engine is not shutdown.
22	Input from temperature switch. If the configurable input is normal, contact closure to input active if the configurable input is fail safe, contact open to Input active.
23	Input from low oil switch. If the configurable input is normal,contact closure to input active. If the configurable input is fail safe, contact open to input active.
24	Input from charge generator.It can be used to detect when engine has started

4. RS-232 SERIAL INTERFACE, PROGRAMMING THE DEVICE OVER PC OR MODEM

4.1 Cable Connection Between RS-232 Terminal of the Device and PC

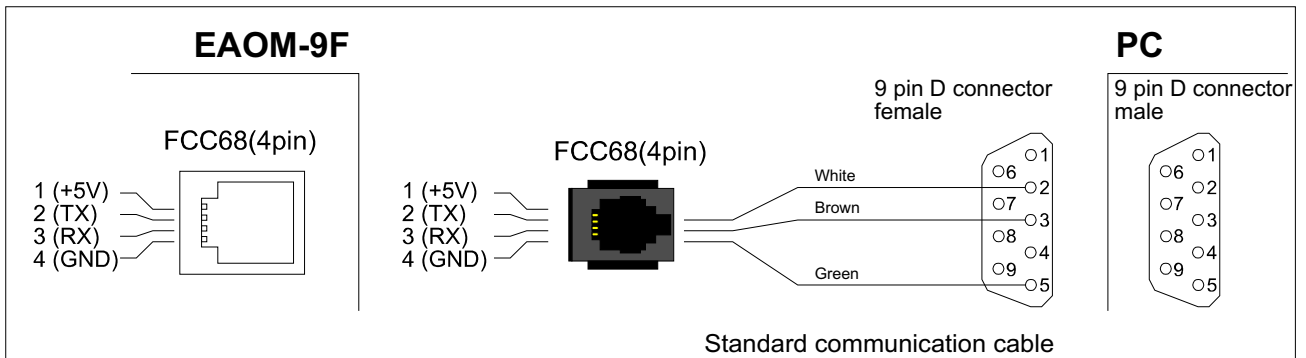

4.2 Cable Connection Between RS-232 Terminal of the Device and Modem

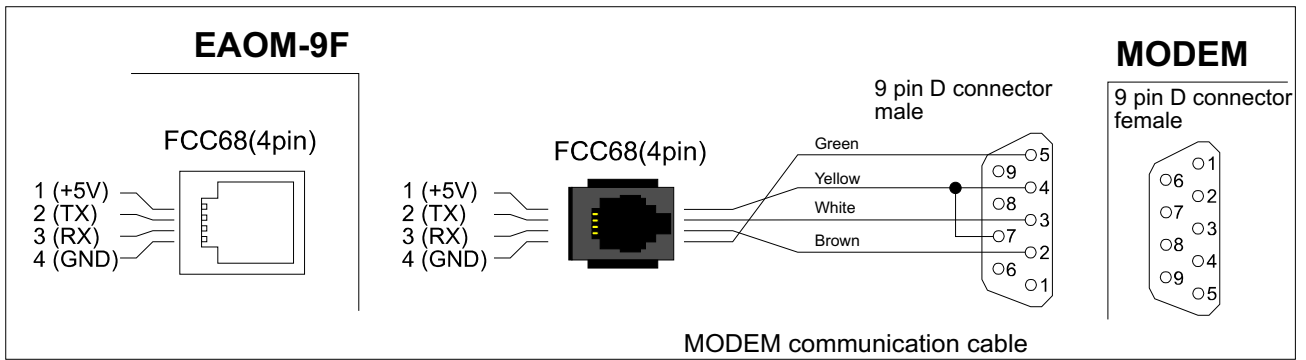

Note: For 9600 baud rate, cable length must be maximum 10 meters.

4.3 PC Interface

The PC interface kit comprises of a 9 pin D connector/FCC68(4 pin) connection lead with 2 meters of cable, and the optional PC Software (Supplied on CD-ROM)

4.3.1 Technical Specifications

RS-232 **non-isolated** Serial interface
9600 Baud Rate
8 data bits, No Parity, 1 Stop Bit
Maximum allowable cable length is 10 meters

4.3.2 Installation Instruction

4.3.2.1 Minimum System Requirements

Processor	: 486 66MHZ
Operating Systems	: Windows 95/98/XP, Windows NT, Windows 2000
Ram	: 16 Mbyte
Monitor	: 14" SVGA (640x480 resolution)
Fixed Disk Free Space	: 5 Mbyte
Disk Drive	: CD-ROM
Communication	: An RS-232 communication port is needed to communicate with the EAOM-9F / EAOM-9F ND unit

4.3.3 Installing EAOM-9F / EAOM-9F ND Software

Insert the software CD into the CD-ROM drive on the PC. CD will autostart, then select EAOM-9F / EAOM-9F ND Install from the menu .

4.3.4 Using Of EAOM-9F / EAOM-9F ND Communication Software

Press the windows START button icon, then select EAOM-9F / EAOM-9F ND SW EAOM-9F / EAOM-9F ND from the program Menu.

4.3.5 Description

EAOM-9F / EAOM-9F ND unit communicates with the PC using RS-232 communications. The PC software allows the EAOM-9F / EAOM-9F ND unit's parameters and status information to be displayed on the PC screen. Operator and Technician parameters can be viewed. Parameters are password protected.

There are four windows in EAOM-9F / EAOM-9F ND PC SW: Observation Window, Operator Parameters Window, Technician Parameters Window and Adjustment Window.

4.3.6 Observation Window

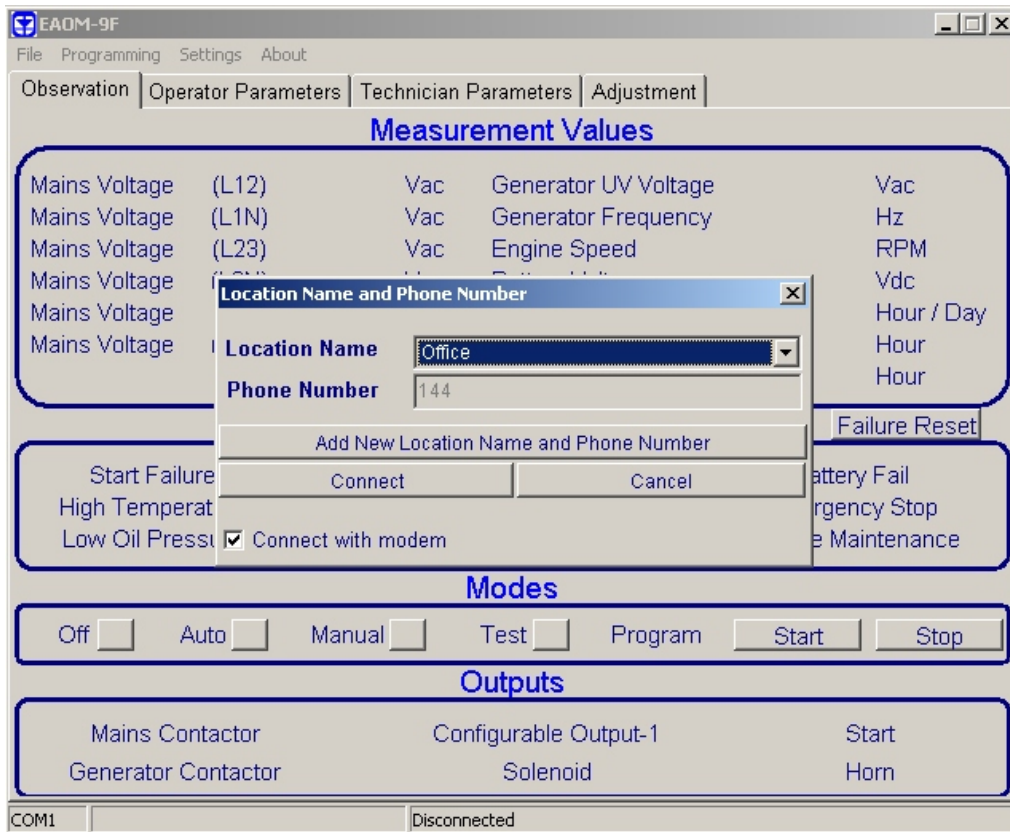

When the program runs firstly, a window is shown to determine how the connection will be established: over modem or RS-232 communication port. This selection is made with the 'Connect with Modem' check box. If the comport settings are correct, when 'Connect' button is pressed, connection is established. With 'Add New Phone Number' button, user can access to the window below and save the location name and phone number for using to connect with modem.

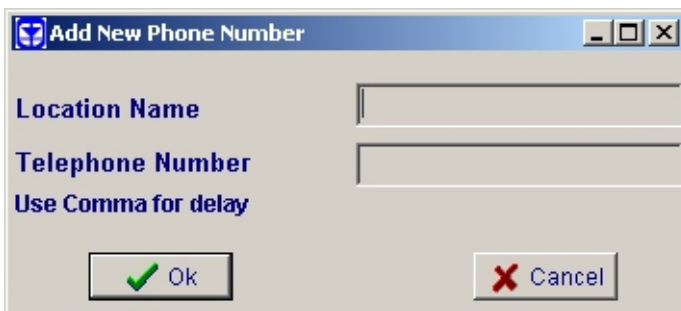

Firstly, enter phone number and location name (It is used to remember where the phone number belongs) and press 'OK' button for saving these values.

When the connection is established, main screen is shown.

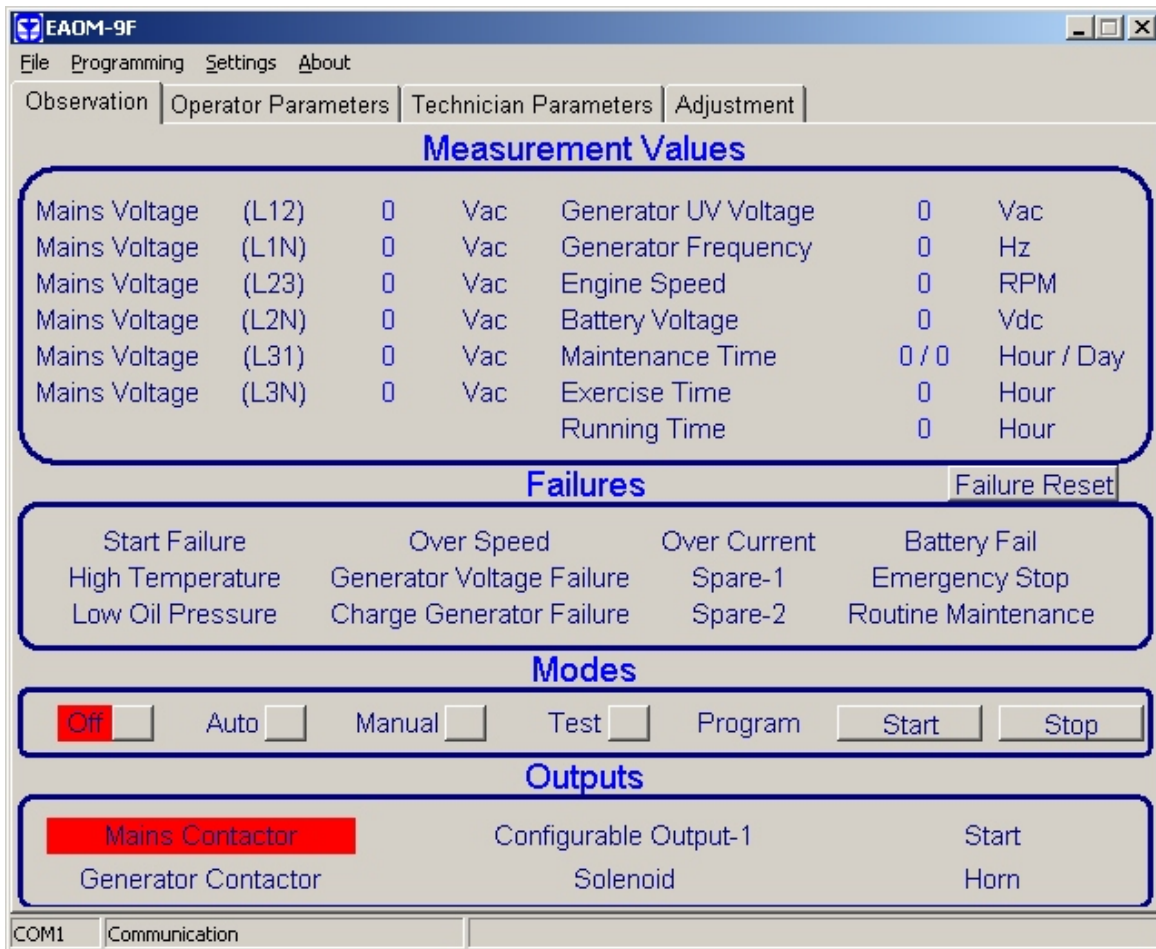

Measurement Values

Mains Voltage
 Generator Voltage
 Generator Frequency
 Battery Voltage
 Maintenance Hour
 Running Time
 Exercise Time

Outputs

Mains Contactor Output
 Generator Contactor Output
 Configurable Output-1
 Solenoid output
 Start output
 Horn output
 Serial communication port (RS-232)

Failures

Start Failure
 High Temperature
 Low Oil Pressure
 Over Speed
 Generator Voltage Failure
 Charge Generator Failure
 Over Current
 Configurable Inputs 1 & 2
 Battery Fail
 Emergency Stop
 Routine Maintenance

Modes

Off
 Auto
 Manual
 Test
 Program

4.3.7 Operator Parameters Window

Operator parameters can be viewed and edited. Parameters are password protected. When the operator password is entered, it is compared with operator password that is registered inside the EAOM-9F / EAOM-9F ND unit.

4.3.8 Technician Parameters Window

All parameters can be viewed and edited in this window. Parameters are password protected. When the technician password is entered, it is compared with technician password that is registered inside the EAOM-9F / EAOM-9F ND unit.

4.3.9 MAIN MENU

4.3.9.1 FILE

With this menu, a configuration file can be opened, parameters can be saved, printed and printer settings can be changed.



- Open** :This menu allows the user to load the registered configuration files to the PC.
- Save** :This menu allows the user to save the parameters with a name defined by user.
- Print** :This menu allows the user to print the parameters.
- Printer Setup**:This menu allows the user to select the printer that is connected to network or PC and change the configuration of the printer.
- Exit** :Exit the program.

4.3.9.2 PROGRAMMING

This menu is active if operator or technician parameters page is accessed. With this menu, parameters can be read from the device or write to the device.



- Download** : With this menu user can load parameters from PC to EAOM-9F / EAOM-9F ND .
- Upload** : User can load the parameters stored on EAOM-9F / EAOM-9F ND unit to PC.
- Add New Phone Number** : User can be saved the phone number which is used for connecting with the modem.

4.3.9.3 Settings

Communication Port Settings: With this menu, user can determine the serial port configurations of the PC

Language: Turkish or English can be selected.

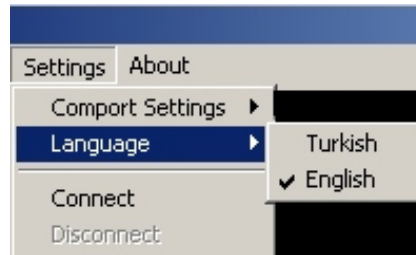
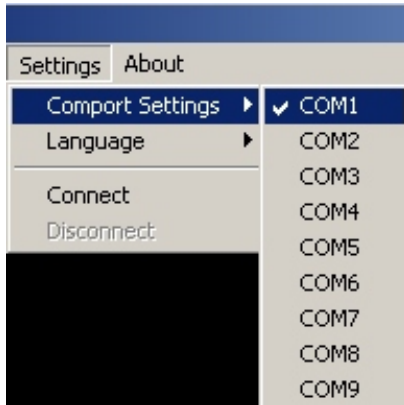

Connect: With this menu, the window below is observed. According to the 'Connect with Modem' check status, connection can be establish over RS-232 port or modem. If the comport settings are done correctly, when the 'Connect' button is pressed, connection is established.

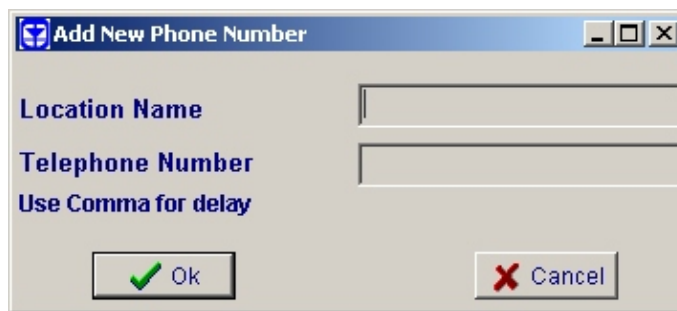

Disconnect: If the connection is established over modem or RS-232 port, connection can be cut off with this selection.

4.3.10 Accessing to the Operator Parameters Page

Click Operator Parameter tab. Enter the operator password. If the password is correct, operator parameters will be viewed.

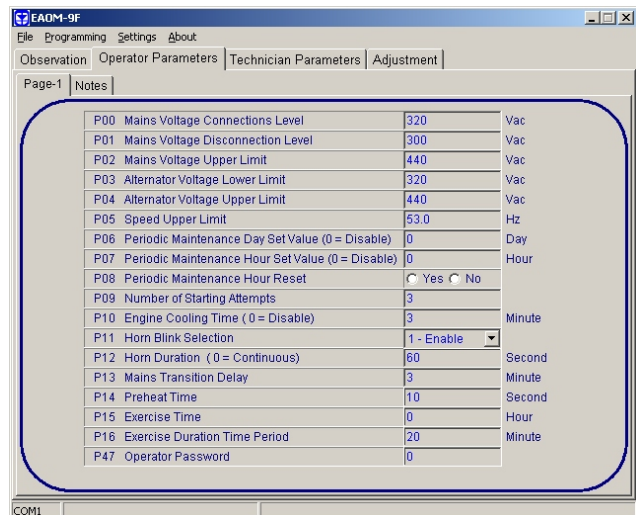
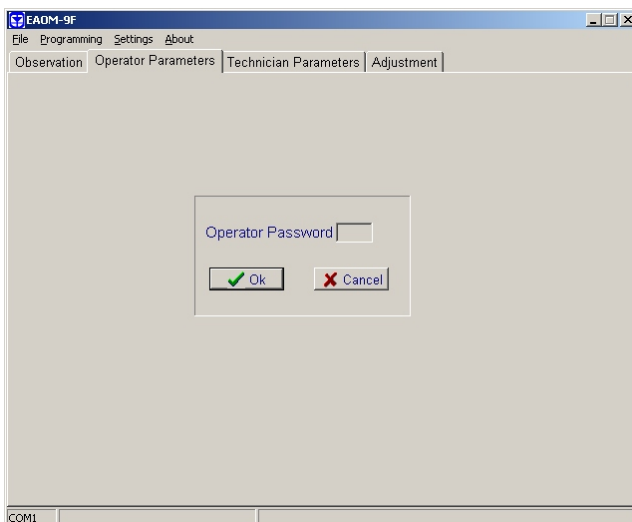

4.3.11 Accessing to the Technician Parameters Page

Click Technician Parameter tab. Enter the technician password. If password is correct, all parameters will be viewed.

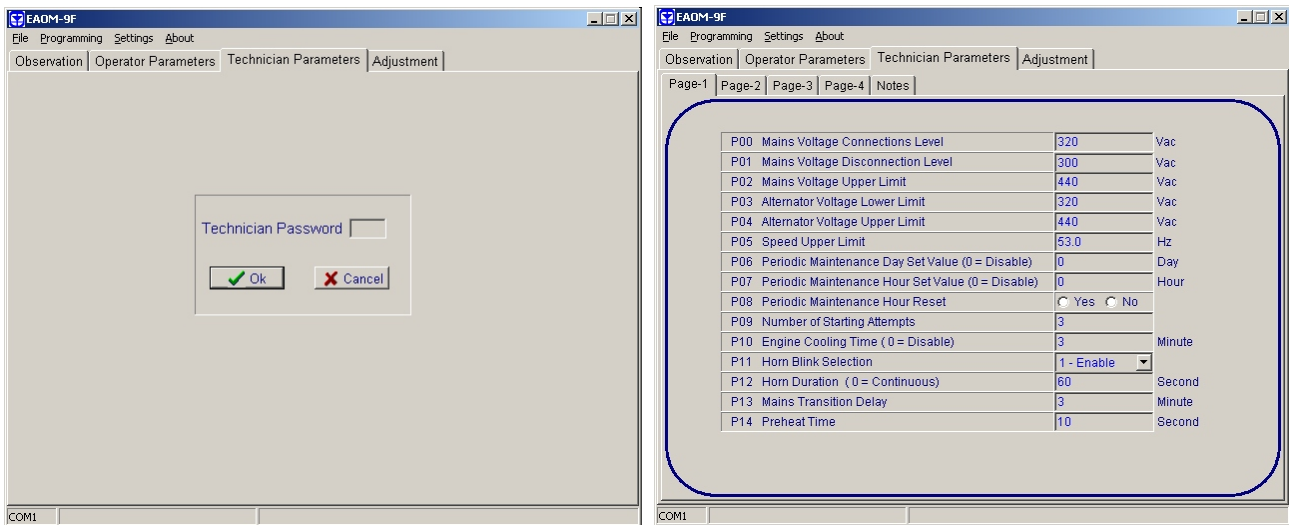

4.3.12 Accessing to the Adjustment Page

Click Adjustment tab. Enter the technician password. If the password is correct, adjustment page will be shown.

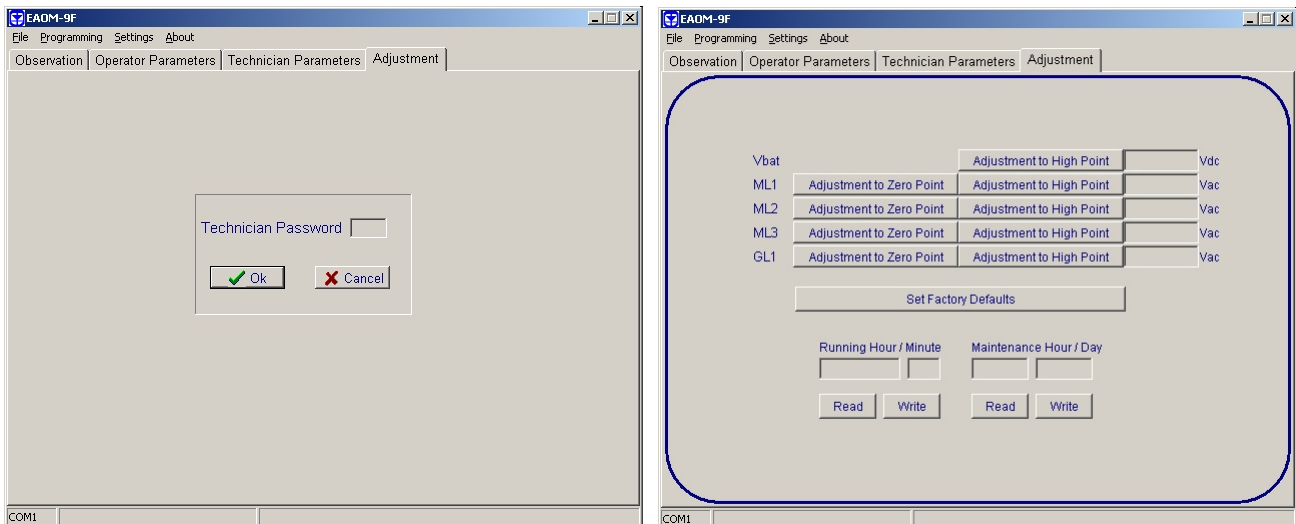

4.3.13 Load the Configuration File From Disc

Click 'Open' in File menu. Choose configuration file which includes operator or technician parameters on Open Dialog Box. When the user clicks the 'Open' button on the Open Dialog Box, parameters will be transferred to PC window.

4.3.14 Save the Configuration File to the Disc

Click 'Save' in File menu. After choosing where to save the file, enter the file name. When the user clicks the 'Save' button on Save Dialog Box, all parameters will be saved to the file.

4.3.15 Upload

For loading parameters from EAOM-9F / EAOM-9F ND unit to PC follow the steps below. If user is in operator parameters window, only operator parameters will be viewed. If user is in Technician Parameters Window, all parameters will be viewed. Press 'Upload' in Program menu. While loading the parameters, the hour-glass cursor is displayed. Please wait for the upload operation to complete, when the cursor returns to normal.

4.3.16 Download

For loading parameters from PC to EAOM-9F / EAOM-9F ND follow the steps below. If user is in operator parameters window, only operator parameters will be loaded. If user is in Technician Parameters Window, all parameters will be loaded. Press 'Download' in Program menu. While loading the parameters, the hour-glass cursor is displayed. Please wait for the download operation to complete, when the cursor returns to normal.

5. PARAMETERS

The unit is extensively programmable through the front panel and via PC software.

Table 4 Programmable function definitions

No	Definition of Parameter	Min	Max	Default	Unit
P00	Mains Voltage Connection Level	60	600	320	V~
P01	Mains Voltage Disconnection Level	60	600	300	V~
P02	Mains Voltage Upper Limit	60	600	440	V~
P03	Alternator Voltage Lower Limit	60	600	320	V~
P04	Alternator Voltage Upper Limit	60	600	440	V~
P05	Speed Upper Limit	30.0	75.0	53.0	Hz
P06	Periodic Maintenance Day Set Value(0 = dis)	0	999	365	Day
P07	Periodic Maintenance Hour Set Value(0 = dis)	0000	9999	5000	Hour
P08	Periodic Maintenance Hour Reset	Press 'Silence Alarm' button to reset			
P09	Number of Starting Attempts	1	10	3	Number
P10	Engine Cooling Time(0 disable cool process)	0	99	3	Minute
P11	Horn Blink Selection	0=None, 1=Exists		1	
P12	Horn Duration (0 Continuous)	0	999	60	Second
P13	Mains Transition Delay	0	30	3	Minute
P14	Preheat Time	0	99	10	Second
P15	Exercise Time (0 Disable)	0	999	0	Hour
P16	Exercise Duration Time Period	0	999	20	Minute
P17	Single / Three Phase Selection	1/3		3	
P18	Speed Sensing Input Selection	0=Alternator Signal (Internal) 1=Magnetic Pickup		0	
P19	Nominal Alternator Frequency	50.0/60.0		50.0	Hz
P20	Nominal Speed	500	5000	3000	Rpm
P21	Tooth Number	1	1000	100	Number
P22	Battery Voltage Lower Limit	7.2	24.0	8.0	V---
P23	Mains Change Over Delay	0.1	25.0	1.0	Second
P24	Stop / Fuel Solenoid Selection	Stop / Fuel		Fuel	
P25	Stop Magnet Energising Time	0	99	20	Second
P26	Engine started signal	0=No, 1=Yes			
	P26.0 Charge Generator	0/1		1	
	P26.1 Speed	0/1		0	
	P26.2 Alternator Voltage	0/1		1	
	P26.3 Oil Pressure	0/1		0	
P27	Engine Starting Delay	0.0	25.0	0.0	Second
P28	Starting Attempt Duration	5	99	5	Second
P29	Alternator voltage limit for crank disconnection	40	360	300	V~
P30	Speed Limit for Crank Disconnection	20.0	45.0	40.0	Hz
P31	Oil Pressure By-Pass Time	0	99	30	Second
P32	Control on Delay	0	99	10	Second
P33	Alternator Voltage Fault Control Delay	0.0	10.0	5.0	Second
P34	Speed Fault Control Delay	0.0	10.0	5.0	Second
P35	Engine running time reset	Enter technician password to reset time to "0" (zero)			
P36	"Power ON" default mode configuration	0=Off,1=Auto		0	Number

No	Definition of Parameter	Min	Max	Default	Unit
P37	Normal / Fail safe configuration of inputs	0	31	0	Number
	0 All normal				
	1 Temperature Fail-safe				
	2 Pressure Fail-safe				
	3 Temp. + Pressure Fail-safe				
	4 Conf. Input1 Fail-safe				
	5 Conf. Input1 + Temp. Fail-safe				
	6 Conf. Input1 + Pressure Fail-safe				
	7 Conf. Input1 + Temp + Pressure Fail-safe				
	8 Conf. Input2 Fail-safe				
	9 Conf. Input2 + Temp. Fail-safe				
	10 Conf. Input2 + Pressure Fail-safe				
	11 Conf. Input2 + Temp + Pressure Fail-safe				
	12 Conf. Input1 + Conf. Input2 Fail-safe				
	13 Conf. Input1 + Conf. Input2 + Temp. Fail-safe				
	14 Conf. Input1 + Conf. Input2 + Pressure Fail-safe				
	15 Conf. Input1 + Conf. Input2 + Pressure + Temp. Fail-safe				
	16 Current Fail-safe				
	17 Current + Temp. Fail-safe				
	18 Current + Pressure Fail-safe				
	19 Current + Pressure + Temp. Fail-safe				
	20 Current + Conf. Input1 Fail-safe				
	21 Current + Conf. Input1 + Temp. Fail-safe				
	22 Current + Conf. Input1 + Pressure Fail-safe				
	23 Current + Conf. Input1 + Pressure + Temp. Fail-safe				
	24 Current + Conf. Input2 Fail-safe				
	25 Current + Conf. Input2 + Temp. Fail-safe				
	26 Current + Conf. Input2 + Pressure Fail-safe				
	27 Current + Conf. Input2 + Pressure + Temp. Fail-safe				
	28 Current + Conf. Input2 + Conf. Input1 Fail-safe				
	29 Current + Conf. Input2 + Conf. Input1 + Temp. Fail-safe				
	30 Current + Conf. Input2 + Conf. Input1 + Pressure Fail-safe				
	31 Current + Conf. Input2 + Conf. Input1 + Pressure + Temperature				

No	Definition of Parameter	Min	Max	Default	Unit
P38	Configurable Failure Input-1 Operation:	0	10	0	Number
	0 Force product into AUTO mode				
	1 Disable front panel controls				
	2 LED status indication only				
	3 LED flashes and alarm sounds while input is active				
	4 LED flashes and alarm sounds until reset				
	5 As "4" plus engine stops				
	6 As "2" but only while engine running.				
	7 As "3" but only while engine running.				
	8 As "4" but only while engine running.				
	9 As "5" but only while engine running.				
	10 As "8" and the alternator contactor is de-energised				
P39	Configurable Failure Input-2 Operation: Selections are same with P38	0	10	0	Number
P40	Configurable Input-1 Delay Time	0	10	0	Second
P41	Configurable Input-2 Delay Time	0	10	0	Second
P42	Configurable Output	0	13	0	Number
	0 Alarm output				
	1 Engine running				
	2 Ready for automatic transfer on mains failure				
	3 Preheat. Active for preheat time (P13)				
	4 Load transfer permitted				
	5 Over speed shutdown output				
	6 Over current alarm output				
	7 High temperature alarm output				
	8 Low oil pressure alarm output				
	9 Maintenance due alarm output				
	10 Failed to start alarm output				
	11 Voltage failure alarm output				
	12 Charging fail alarm output				
	13 Low battery voltage alarm output				
P43	Mains Contactor Selection.	0=Mains contactor is NO 1=Mains contactor is NC		0	Number
P44	Motor Fuel (Gas/Diesel) Selection	0=Gas 1=Diesel		1	
P45	Fuel-Starter (Diesel)/Starter-Fuel (Gas) Delay Time	0.0	25.0	2.0	
P46	Remote Control Mode Selection	0	2	0	
	0 Prevent running				
	1 Run without load				
	2 Run with load				
P47	Operator Password (P00 to P16 and P47)	0000	9990	0000	Number
P48	Technician Password (P00 to P48)	0000	9990	0000	Number

5.1 Program Functions

5.1.1 Mains Voltage

P00 Mains Voltage Connection Level
P01 Mains Voltage Disconnection Level
P02 Mains Voltage Upper Limit
P13 Mains Transition Delay

In Automatic mode, the unit uses these parameters to decide when to switch the load between the mains supply and the alternator – assuming the alternator is providing a satisfactory output. If the mains voltage is higher than the Upper Limit or lower than the Disconnection Level, the unit connects the load to the generator instead of to the mains.

If the load is running on the mains and the mains voltage falls, the unit will switch the load to the generator when the mains voltage falls below the Disconnection Level. Conversely, if the mains voltage is low and the load is running on the generator, the unit will not restore the mains supply to the load until the mains voltage is between Connection Level and Mains Voltage Upper Limit for Mains Transition Delay (P13) value. This hysteresis prevents constant switching between mains and generator as the mains varies about the switching levels. Figure 5.1 shows how, in automatic mode, the load is transferred between mains and generator as the mains voltage varies over time.

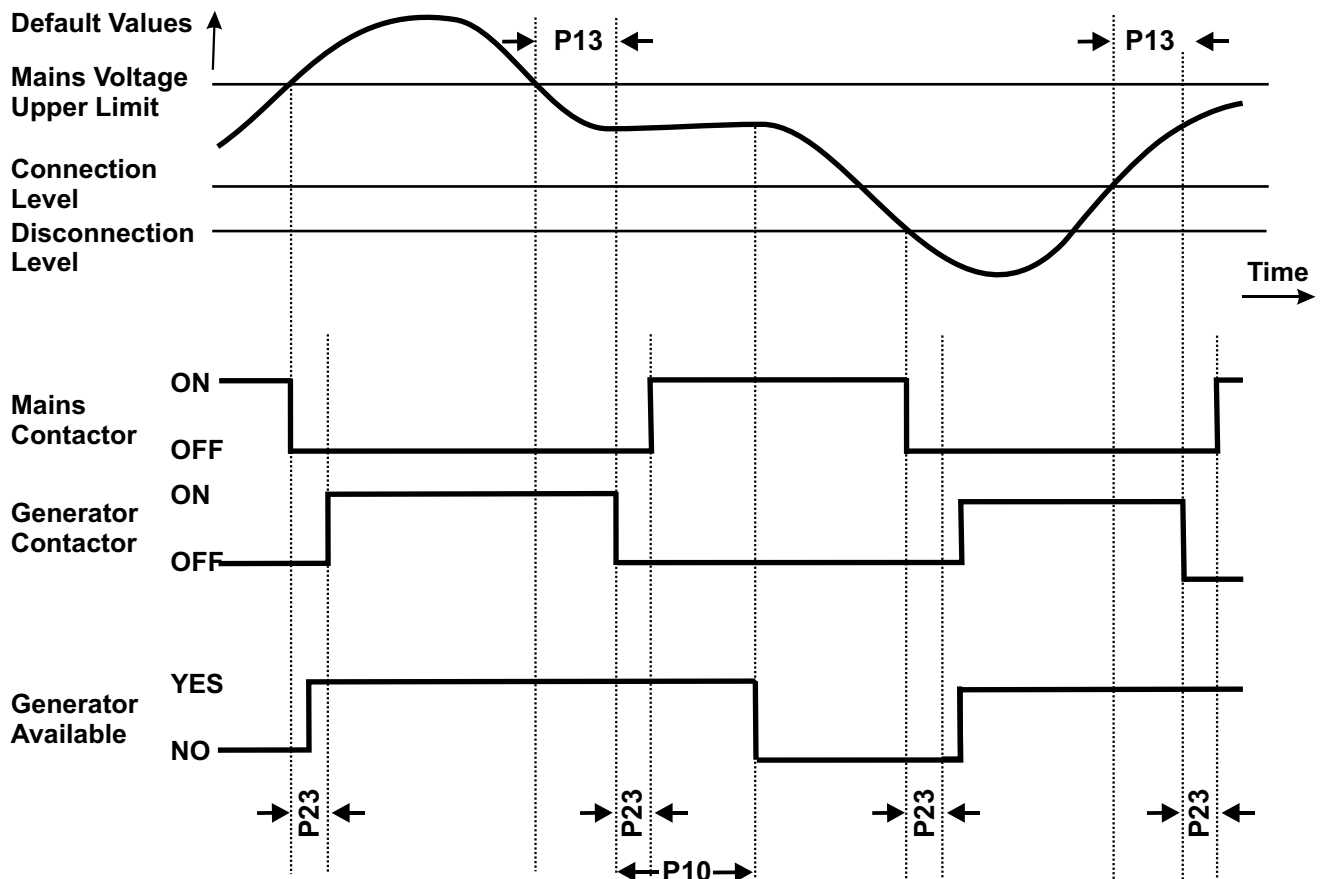

Figure 5.1

P10 = Engine Cooling Time
P13 = Mains Transition Delay
P23 = Mains Change Over Delay

5.1.2 Alternator Voltage

P03 Alternator Voltage Lower Limit
P04 Alternator Voltage Upper Limit
P33 Alternator Voltage Fault Control Delay

A fault will be reported if the alternator output voltage goes outside the window defined by the upper and lower limits for more than the time defined as the Alternator Voltage Fault Control Delay (P33). The fault will only occur if the engine has been running for the period defined as the Control on Delay (P32). This failure immediately stops the generating set without Engine Cooling Time (P10)

5.1.3 Alternator Frequency

P05 Speed Upper Limit
P34 Speed Fault Control Delay

A fault will be reported if the alternator output frequency exceeds the upper limit for more than the time defined as the Speed Fault Control Delay (P34). The fault will only occur if the engine has been running for the period defined as the Control on Delay (P32). This failure immediately stops the generating set without engine cooling time.

5.1.4 Engine Cooling Time (P10)

While generator is running on-load and if mains is available, load is taken to the mains. Generator runs off-load during Engine Cooling Time (P10) to cool down before shut-down. (Figure 5.1)

5.1.5 Battery Voltage Lower Limit (P22)

If the battery voltage drops below the defined Battery Voltage Lower Limit (P22), an alarm occurs and "Low Battery Failure" LED illuminates.

5.1.6 Engine Starting

Number of Starting Attempts (P09)
Starting Attempt Duration (P28)

When the EAOM-9F / EAOM-9F ND receives an Engine Start command, it energises the start solenoid to drive the starter motor and energises the Fuel solenoid (if selected – see Section 5.1.9 Stop/Fuel selection) Starting attempt duration (P28) defines the maximum period for the start solenoid output is being active if one of the Engine Started Signals is not received (Refer to 5.1.7). It makes a new attempt after a delay equal to twice the defined Starting attempt duration (P28). Number of starting attempts (P09), defines the number of unsuccessful tries that the EAOM-9F / EAOM-9F ND will make before abandoning the attempts. If all these attempts fail, EAOM-9F / EAOM-9F ND will stop the starting attempts and start failure indication is displayed. Start failure can be reset with reset button.

5.1.7 Engine Started Signals (P26)

If the unit detects that the engine is running, it will de-energise the start solenoid to disconnect the starter motor. Conversely, if the engine does not start after the starting attempt duration, the unit will turn off the starter motor and wait twice of the Starting Attempt Duration (P28) then start again. Hence, the unit must be able to detect when the engine has started. Four signals are available to provide engine running information, as follows:

0. Charge Generator (P26.0); from charging generator energising coil current.

1. Speed (P26.1); if engine speed is higher than Speed Limit for Crank Disconnection (P30), pay attention to the Speed Sensing Input Selection (P18) (Refer to 5.1.8)

2. Alternator Voltage (P26.2); if alternator voltage is higher than Alternator Voltage Limit for Crank Disconnection (P29)

3. Oil Pressure (P26.3); it looks if oil pressure switch is closed

It is advisable to select at least two of them - preferably 1) Engine Speed and either 0) Charge Generator or 2) Alternator Voltage.

If any of the selected signals appears, the unit assumes that the engine has started.

5.1.8 Speed Sensing Input Selection (P18)

This parameter specifies the method by which the unit monitors generator speed. The choice is between alternator frequency and external magnetic pick-up. Speed is monitored so as to detect when the engine has started. See Sections 5.1.3 Alternator Frequency, 5.1.7 Engine started signals (P25) and 5.1.6 Engine Starting.

Where alternator frequency is used, Nominal Alternator Frequency (P19) and Nominal Speed (P20) must be set correctly

Where the magnetic pick-up is used, Nominal Alternator Frequency (P19), Nominal Speed (P20) and Tooth Number (P21) must be set correctly.

5.1.9 Stop / Fuel Solenoid Selection (P24)

This parameter allows the use of either a Stop solenoid or a Fuel solenoid. (See Section 5.1.6 Engine Starting.)

If Fuel Solenoid selected, the fuel solenoid will be energised while the engine is running and de-energised to cut off the fuel and stop the engine.

If Stop Solenoid selected, the stop solenoid is normally de-energised and only energised to stop the engine. The solenoid remains energised for the period defined as the Stop Magnet Energising Time (P25).

5.1.10 Stop Magnet Energising Time (P25)

This parameter sets the period for which the Stop solenoid is energised to stop the engine. It applies only where parameter Stop / Fuel Solenoid Selection (P24) is set to Stop Solenoid.

5.1.11 Oil Pressure By-Pass Time (P31)

This sets the delay before a Low Oil Pressure warning will be generated. The Low Oil Pressure fault indicator will light if the oil pressure switch contact remains opened, while the engine is running, after the period defined by parameter. This period begins when the EAOM-9F / EAOM-9F ND has detected engine starting and has cut off the drive to the starter motor. This failure immediately stops the generating set, without Engine Cooling Time (P10).

5.1.12 Control On Delay (P32)

During the initial period after the engine has been started, there can be fluctuations in engine speed and alternator output that could generate spurious fault indications. Control On Delay (P32) defines a period during which any fault indications, except High Temperature, will be ignored by the EAOM-9F / EAOM-9F ND. Also, in the event of a mains failure, transfer of the load from mains to generator will be delayed until the end of the Control On Delay (P32) period. This period begins when the EAOM-9F / EAOM-9F ND has detected engine starting and has cut off the drive to the starter motor.

5.1.13 Configurable Inputs

P37 Normal / Fail safe Configuration of Inputs

P38 Configurable Input-1 Operation

P39 Configurable Input-2 Operation

P40 Configurable Input-1 Delay Time

P41 Configurable Input-2 Delay Time

Temperature, Pressure, Configurable Input-1, Configurable Input-2 and Over current failure inputs can be configured individually as a “normal” or “fail safe” input by Normal / Fail Safe Configuration of Inputs (P37) parameter.

If the configurable input is normal, contact closure to input active,

If the configurable input is fail safe, contact open to input active,

On any of these inputs causes the horn to sound for the period programmed by Horn Duration (P12) and lights the appropriate indicator on the panel. The EAOM-9F / EAOM-9F ND can be configured to respond in any of eleven different ways to each one of these inputs. If the input is active, according to the parameter selection, the events that are listed below occurs:

0. The unit changes over to AUTO mode

1. The front panel is disabled

2. The led continuously lights on with no flash

3. Indication is unlatched - the LED flashes. This input has no effect if any other alarm condition is present.

4. Indication is latched. The LED flashes while the horn is sounding and then stays on until the Failure Reset button is pressed.

5. As 4 in addition, the engine is shut down.

Options 6...10 are effective only while the engine is running.

6. As 2

7. As 3

8. As 4

9. As 5

10. As 8

5.1.14 “Power ON” Default Mode Configuration(P36)

The unit's initial default mode is “OFF” when power is switched on. The default mode can be configured to “AUTO” by adjusting this parameter.

5.1.15 Configurable Output (P42)

When active, this output provides battery voltage (12 V_{DC} or 24 V_{DC}) and can be programmed in one of four different ways:

0. Alarm output. Active when any fault is reported until reset. It can be used for either audible or visual alert.
1. Engine running. Active while the engine is running
2. Output is active after one second while the unit is in Test or Auto mode. Output is passive when the unit is Off or manual.
3. Preheat function. On starting the output is active for time period defined in Preheat Time (P14) prior to running the starter motor.
4. Load transfer permitted. This output is active while the alternator output voltage is between Mains Voltage Connection Level (P00) and Mains Voltage Disconnection Level (P01). This output can be used to control a contactor that transfers the load to the alternator once the generator set is up and running.
5. Over speed shut-down output. The fault will only occur after the engine has been running for the period defined as the Starting Attempt Duration (P28) and Alternator Voltage Lower Limit (P03). This failure immediately stops the generating set, without Engine Cooling Time (P10) and activated this output.
6. Over current alarm output. Active when over current fault is report.
7. High temperature alarm output. Active when high temperature fault is reported.
8. Low oil pressure alarm output. Active when low oil pressure fault is reported.
9. Maintenance due alarm output. Active when maintenance due fault is reported.
10. Failed to start alarm output. Active when failed to start fault is reported.
11. Voltage failure alarm output. Active when voltage failure fault is reported.
12. Charging fail alarm output. Active when charging fail fault is reported.
13. Low battery voltage alarm output. Active when low battery voltage fault is reported.

5.1.16 Maintenance Indication

P06 Periodic Maintenance Day Set Value
P07 Periodic Maintenance Hour Set Value
P08 Periodic Maintenance Hour Reset

To ensure reliability, the generator must be serviced at regular intervals. The EAOM-9F / EAOM-9F ND can be set to indicate when a service is due. Set Periodic Maintenance Day Set Value (P06) to the number of running hours between services. Use Periodic Maintenance Hour Set Value (P07) to reset the hours counter at each service. When the engine has run for the defined number of hours, the LED with exclamation mark will flash.

The maintenance alarm is also triggered after a fixed time period P06 (90-365 days).

5.1.17 Operator Password (P47)

Use this option to change the Operator password. This password allows access to the parameters from Mains Voltage Connection Level (P00) to Exercise Duration Time Period (P16) and Operator Password (P47).

5.1.18 Technician Password (P48)

Use this option to change the Technician password. It allows access to the all parameters: from Mains Voltage Connection Level (P00) to Technician Password (P48).

5.1.19 Engine Exercise Function

P15 Exercise Time

P16 Exercise Duration Time Period

This function allows the engine to be run automatically, without load, at fixed intervals, as specified by Exercise Time(P15). The engine runs for the number of minutes specified by Exercise Duration Time Period (P16). Exercising will only occur if the unit is set to Auto mode when exercising is due. To disable exercising, set Exercise Time (P15) to zero.

5.1.20 Mains Contactor Control Selection (P43)

The contact output can be configured for Normally Open or Normally Closed contactors. Parameter value "0" (default) selects Normally Open, "1" selects Normally Closed.

5.1.21 Horn Blink Selection (P11)

If the parameter is 0, if a failure occurs, horn output is active during Horn Duration (P12) or until the failures are removed.

If the parameter is 1, horn output is active for 1 second and passive for 1 second during Horn Duration (P12) or till the failures are removed.

5.1.22 Motor Çalıştırma Geciktirmesi (P27)

In automatic or test mode, when it is necessary to run the generator, generator starts to run after this time.

5.1.23 Engine Fuel Selection and Fuel-Starter Delay Time

Motor Fuel (Gas/Diesel) Selection (P44)

Fuel-Starter (Diesel) / Starter-Fuel (Gas) Delay Time (P45)

If Gas is selected (P44=0), when generator starts to run, firstly start output active then after Fuel-Starter (Diesel) / Starter-Fuel (Gas) Delay Time (P45) solenoid output becomes active.

If Diesel is selected (P44=1), when generator starts to run, firstly solenoid output active then after Fuel-Starter (Diesel) / Starter-Fuel (Gas) Delay Time (P45) start output becomes active.

5.1.24 Remote Control Mode Selection (P46)

In Automatic mode, device can prevent to work the generator or work with load or without load with remote inhibit input.

When remote inhibit input is active;

If the parameter is 0, then device prevents to work the generator even all the conditions are supplied.

If the parameter is 1, generator runs even the conditions are not supplied and generator does not take the load during mains voltage is okay.

If the parameter is 2, generator runs even the conditions are not supplied and take the load even mains voltage is okay.

If generator contactor changes over to disconnect the load from the generator and if the mains voltages are okay, mains contactor changes over to connect to load to the mains.

5.2 Changing and Saving Operator Parameter Value

Operation Screen

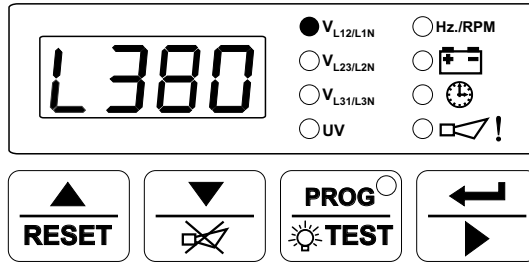

When button is pressed, all leds and digits are energised, because prog button is also used as test button. Continue to press the prog button for 5 seconds, Operator Menu Entering screen is shown and prog led lights on.

Operator Menu Entering Screen

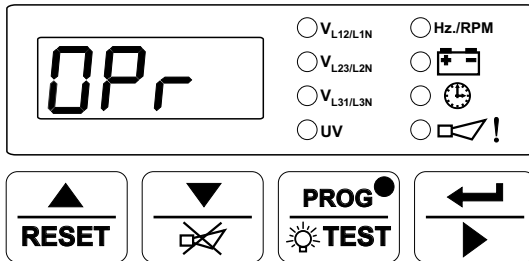

When button is pressed, operator password entering screen is shown.

Operator Password Entering Screen

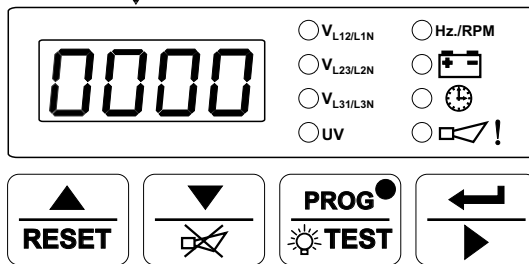

Change the password with and buttons

Operator Password Entering Screen

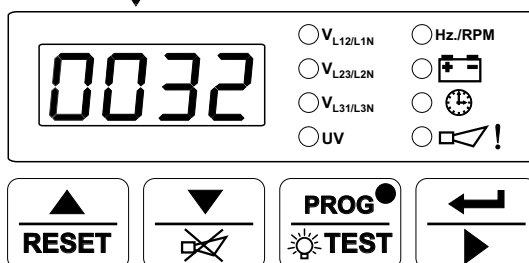

After entering the password, push the button for confirming the password and accessing to the first parameters of operator parameters.

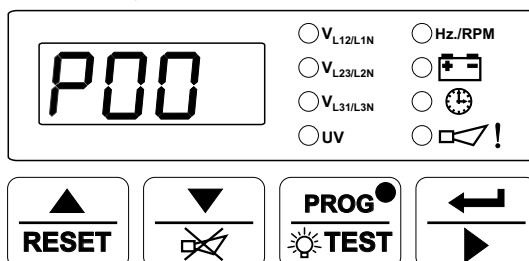

NOTE : If no operation is performed for 20 seconds, the device exits from the programming mode and turns to the main operation screen.

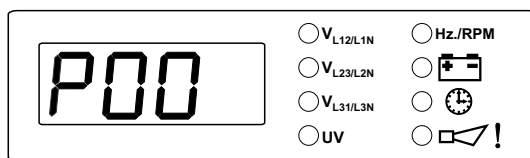

Press  button for accessing to the **P00** Value

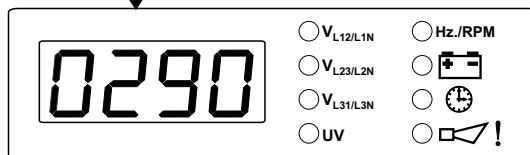
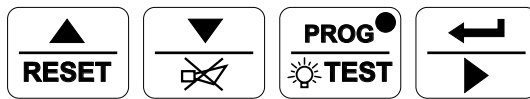

Mains Voltage Connection Level Parameter



Mains Voltage Connection Level Value

Change the **P00** parameter with  and  buttons

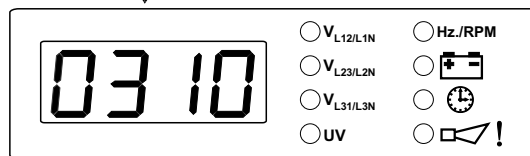
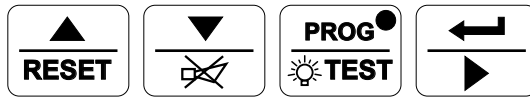

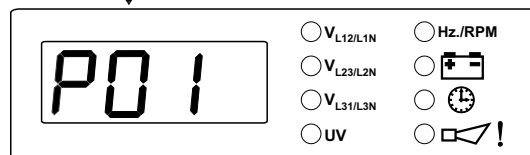
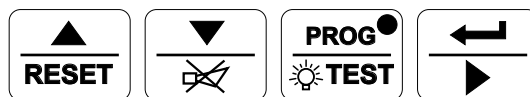

Mains Voltage Connection Level Value

Press  button for saving the **P00** value and accessing to the **P01** Parameter

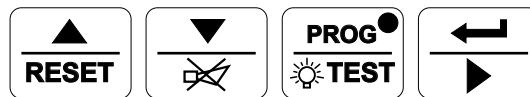

Mains Voltage Disconnection Level Parameter



NOTE : Other operator parameters can be accessed as explained for **P00**
 For exiting from programming mode, press 

NOTE : If no operation is performed for 20 seconds, the device exits from the programming mode and turns to the main operation screen.

5.3 Changing and Saving Technician Parameter Value

Operation Screen

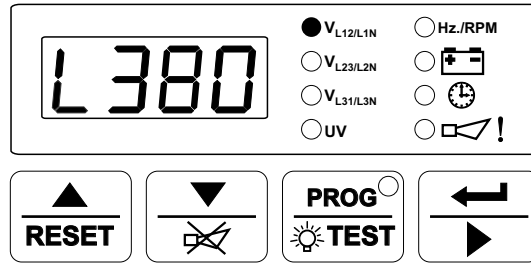

When button is pressed, all leds and digits are energised, because prog button is also used as test button. Continue to press the prog button for 5 seconds, Operator Menu Entering screen is shown and prog led lights on.

Operator Menu Entering Screen

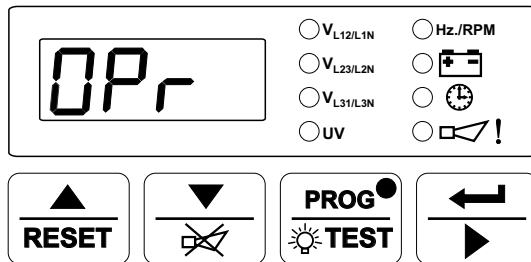

When button is pressed for 10 seconds, technician menu entering screen is shown.

Technician Menu Entering Screen

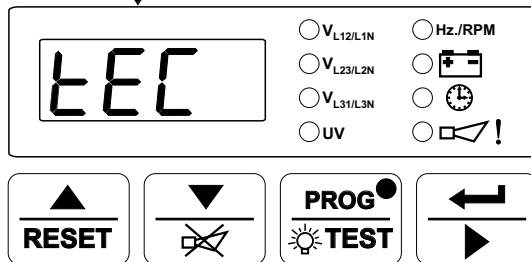

When button is pressed, technician password entering screen is shown.

Technician Password Entering Screen

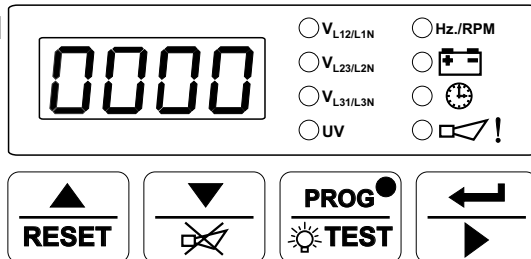

Change the password with and buttons

Technician Password Entering Screen

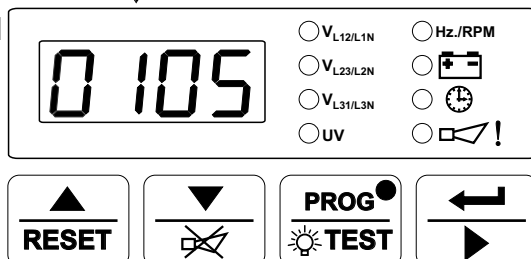

After entering the password, press the button for confirming the password and accessing to the first parameters of technician parameters.

NOTE : If no operation is performed for 20 seconds, the device exits from the programming mode and turns to the main operation screen.

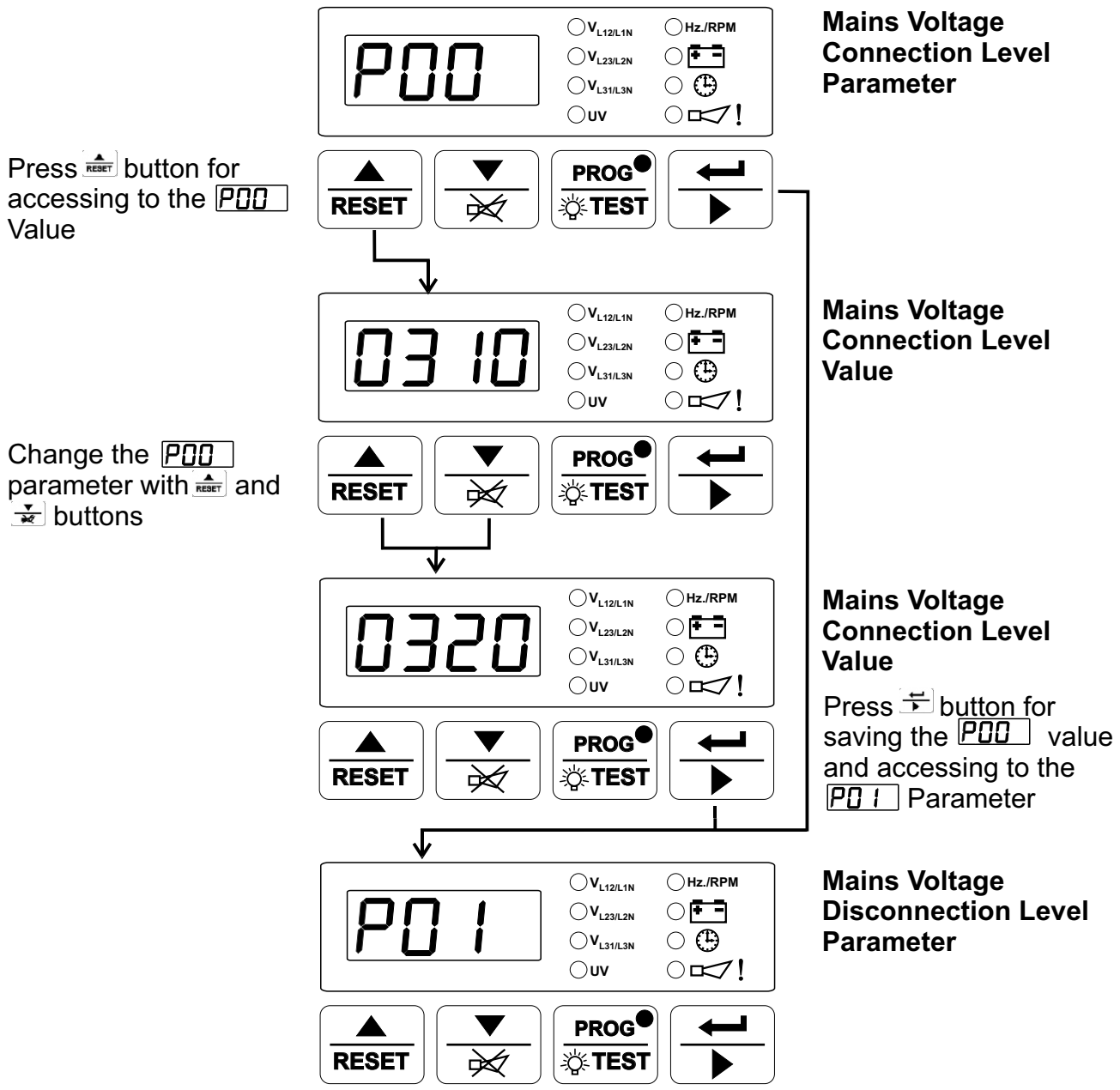

NOTE : Other technician paramaters can be accessed as explained for **P00**
 For exiting from programming mode, press

NOTE : If no operation is performed for 20 seconds, the device exits from the programming mode and turns to the main operation screen.

6. COMMISSIONING

These commissioning checks may interfere with the power supply to the load. Therefore they should not be carried out with a mission-critical load connected to the system.

6.1 Manual Operation

1. Check that the unit is correctly wired and that the wiring is of a standard and rating compatible with the system.
2. Check that the correct fuses are fitted.



3. Be sure that the parameters are suitable for your system. Please refer to the Section 5 Parameters for details.

4. Take temporary steps to prevent the engine from starting (for example, disable the fuel solenoid).
 5. After a visual inspection to ensure it is safe to proceed, connect the battery supply.
 6. On the EAOM-9F / EAOM-9F ND, press the Man (20) button. The associated LED (11) should light.
 7. Press the Engine Start (19) button. The LED (10) should light.
 8. Check that the engine start sequence commences. The starter motor should run for the programmed time period (P28) for the pre-set (P09) number of times.
 9. Check that the Start Failure LED flashes and the LED (10) switches off.
 10. Check that the unit changes to the OFF mode and the LED (12) should light.
 11. Restore the engine to operational state (reconnect the fuel solenoid).
 12. Press the Man (20) button. The LED (11) should light.
 13. Press the Engine Start (19) button. The LED (10) should light.
 14. Check the start sequence, as follows:
 - The starter motor runs
 - The engine starts
 - The starter motor disengages once the engine is running.
- If not, check that the engine is fully operational (fuel available etc.) and check the wiring and programming of the EAOM-9F / EAOM-9F ND.
15. Check that the engine runs up to it's operating speed. If not and an alarm is present, check that the alarm is valid and then check the input wiring.
 16. Press the Engine Stop (18) button. At this moment the LED (9) should light. The engine should stop. Allow time for the engine to come to rest.

6.2. Auto Operation

1. Check that the mains is connected to the unit and is present.
2. Check that the remote inhibit switch (if fitted) is set to disable (contact is open).
3. At the EAOM-9F / EAOM-9F ND, press the Auto (23) button. The LED (14) on the button should light.
4. Switch off the mains supply to the unit. Check that the generator starts and after a delay, the load is transferred to the generator
5. Restore the mains supply to the unit. Check that, after a delay, the load is transferred back to the mains and the generator, after a further delay, shuts down.
6. If a remote inhibit switch is fitted, set it to inhibit (contact is closed)
7. Switch off the mains supply. Check that the generator does not start.
8. Restore the mains supply and set the remote inhibit switch to disable.

6.3 Test Mode Operation

1. Check that the mains is connected to the unit.
2. Press the Test (22) button. The LED (13) should light.
3. Check that the generator starts and that the load is still connected to the mains.
4. Switch off the mains supply. Check that the contactors change over to connect the load to the generator. Check also that the Auto (14) LED is lit. The unit changes operating mode to AUTO Mode automatically.
5. Restore the mains supply. Check that the contactors reconnect the load to the mains supply.
6. Check that the generator shuts down with Engine Cooling Time (P10)

7. LAMP TEST

When  button is pressed, all leds and digits are energised.

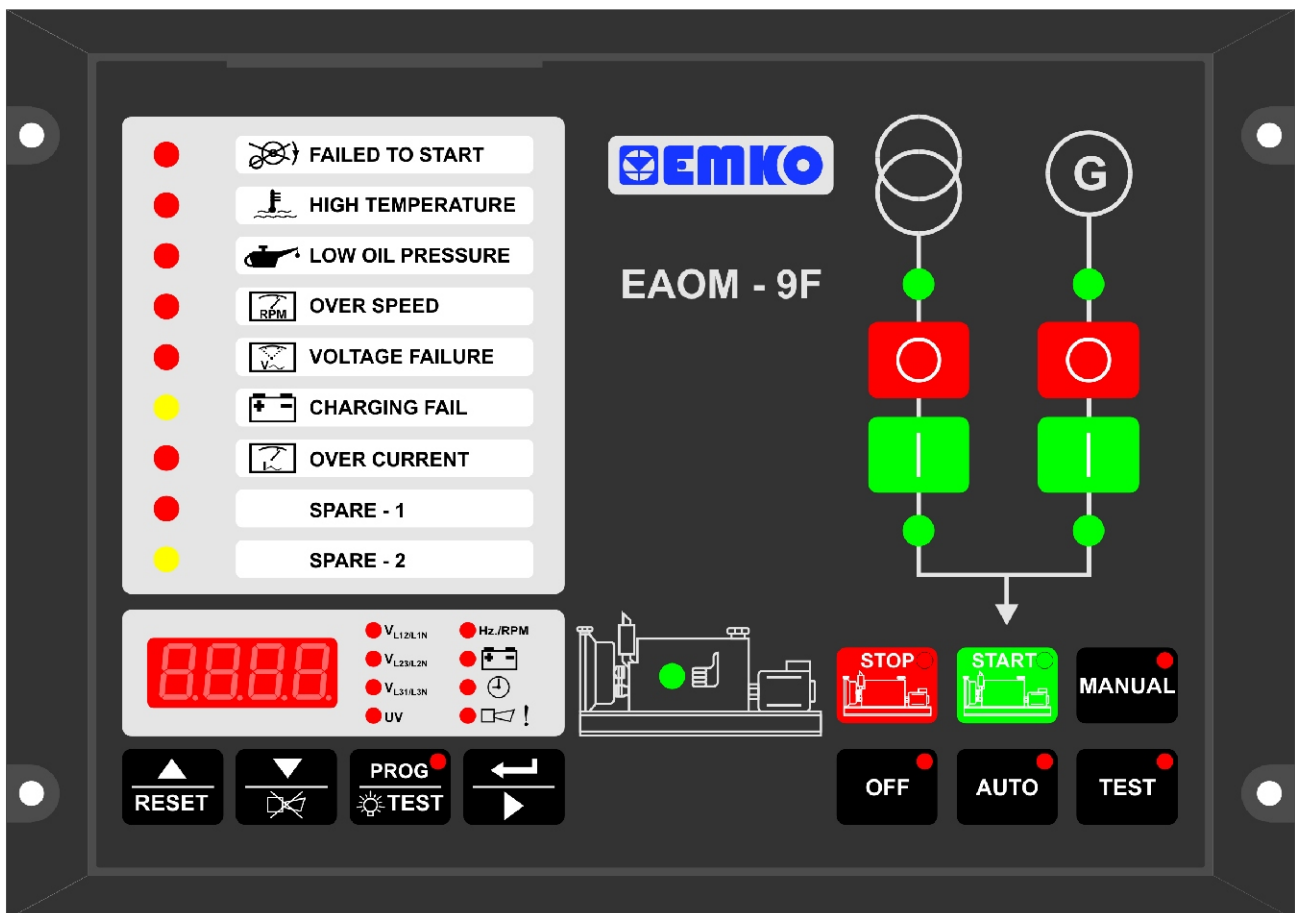

8. OPERATION

8.1 Front Panel Description

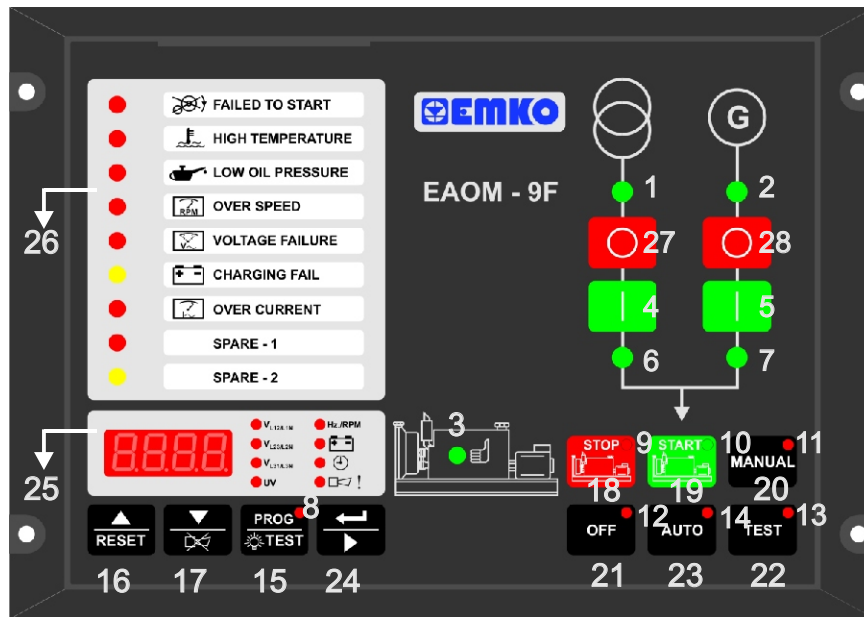

Number	Comment
1	The green LED indicates that Mains Voltage is within suitable limits and is ready to take over the load
2	The green LED indicates that Generator is within suitable limits and is ready to take over the load
3	The green LED indicates that the engine has started and is running.
4	This button closes the mains contactor, only operative when manual mode is selected.
5	This button closes the alternator contactor (only when manual mode is selected)
6	The LED indicates that the load is connected to the mains.
7	The LED shows that the load is supplied from the generator.
8	The red LED illuminates only when EAOM-9F / -9F ND is in programming mode.
9	In the OFF, MAN, AUTO and TEST modes, the red LED indicates that the engine has stopped
10	In the MAN, AUTO and TEST modes, the RED LED indicates that the engine is starting up or is running.
11	This red LED shows that the unit is in the Manual mode.
12	This red LED shows that the unit is in OFF mode.
13	This red LED shows that the Unit is in TEST mode.
14	This red LED shows that the Unit is in the AUTO mode.
15	Prog/Lamp Test. Lights all the LEDs and segments on the panel so that you can see if any are not working. Holding the button pressed for five seconds puts the unit into Programming mode and LED (8) illuminates
16	This button will RESET the controller after a failure has been detected. In Programming mode, it operates as an Increment function (increase value).
17	This button will silence the alarm horn after a failure has been detected. In Programming mode, it operates as a decrement function (decrease value)
18	The Stop button is used for stopping the engine when the unit is in the Manual mode.
19	The Stop button is used for stopping the engine when the unit is in the Manual mode.

Number	Comment
20	The MAN button is used for changing operating mode of the unit to the Manual mode
21	The OFF button is used for changing operating mode of the unit to the Off mode
22	The TEST button is used for changing operating mode of the unit to the Test mode
23	The AUTO button is used for changing operating mode of the unit to the Auto mode
24	The Display Scroll Button  is used for rotating between measurement screen in normal operation and between programming parameters in programming mode.
25	Multi Function Display. This is used for displaying the electrical measurements during normal operation and editing / inspecting programming parameters in programming mode.
26	Failure Indicators. Detailed information available in Section 9
27	This button opens the mains contactor only operative when manual mode is selected
28	This button opens the alternator contactor only when manual mode is selected

8.2 Display Mode Indicators

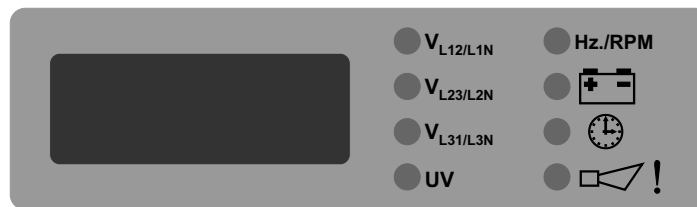

Four-digit, seven-segment LED display, with annunciators to indicate the parameter being displayed. Use the scroll button  to select the desired parameter. The button selects the parameters in sequence, as follows. Note that line to line voltage readings are prefixed by **L** while line to neutral readings are prefixed by **n**

- Mains voltage L1-L2, prefix **L**
- Mains voltage L1-N, prefix **n**
- Mains voltage L2-L3, prefix **L**
- Mains voltage L2-N, prefix **n**
- Mains voltage L3-L1, prefix **L**
- Mains voltage L3-N, prefix **n**
- UV - Alternator voltage L1
- Frequency (Hz)
- Battery voltage ($V_{\text{---}}$)
- Timers

Engine running time, in hours (since last reset). This is a six digit number, the first three digits are prefixed **H** (high) and the second three digits are prefixed **L** (low).

Automatic exercise timer. Elapsed waiting time (hours) to the next exercise is prefixed **E** The exercise running time (minutes) is prefixed **r**

• The Alarm horn LED will flash continually if the unit detects at least one of the faults listed below. When the Display Select button is pressed so as to select this option, the display will show the cause of the fault indication. If more than one error condition is present, repeated pressing of the button will show each in turn.

Possible error messages are:

ES_tP – Emergency Stop

bAT1 – Low Battery Voltage Alarm

Serv – Routine Maintenance due info

8.3 Mode Transition

The mode can be changed at any time. A change in mode will not effect the current state of the generator or load connection. For example; if the unit is in Auto mode with the generator running and the load running on the generator, changing the mode to Manual will not effect the operating state. Any changes between Auto, Manual and Test modes will not change the operating state.

8.4 Manual Start

1. Press the Man (20) button. The LED (11) will switch on.
2. Press the Engine Start (19) button on the panel. The LED (10) will switch on. The engine should start. The sequence is as follows:
 - The starter motor runs
 - The engine startsOnce the engine is running,
 - The LED (3) "Engine Running" illuminates.
 - The "Alternator Ready" LED (2) switches on after "Control on Delay (P30)" time period.
 - The generator will not supply the load unless the "Generator Ready" LED (2) is illuminated (The contactor open / close button does not work)
3. Once both LEDs have illuminated, press the Mains Contactor Button (27) to disconnect the load from the mains supply LED (6) should go off.
4. Press the Generator Contactor Button (5) to connect the load to the generator supply. LED (7) should light.

8.5 Manual Stop

When the "Engine Stop" (18) button is pressed, the LED (9) is illuminated and engine is stopped. When the "Engine Stop" button is pressed while the load is connected to the alternator output (generator output), the alternator contactor is released then the engine is stopped.

8.6 Auto Operation

Press the Auto (23) button to select Auto mode. The LED (14) in the corner of the button will light to indicate this mode has been selected.

In the event of a mains voltage failure, the unit will start up the generator and, once the generator is running and generator is available to take the load, will transfer the load to the generator. When the mains is restored and stable, it will transfer the load back to the mains and, after Engine Cooling Time (P10) shut down the generator.

Note that if 0V in Remote Inhibit (Pin19), it will inhibit engine running.

8.7 Test Operation

Press the Test (22) button to select Test mode. The LED (13) will switch on. This mode allows for testing of the generator off load. All alarm circuits will operate so that any faults will be reported. If a mains failure occurs while the unit is in Test mode, the unit will revert to Auto mode and will switch the load to the generator.

8.8 Engine Exercising

The unit incorporates facilities for exercising the engine on a regular basis. If the unit is in Auto mode, after an interval (hours) determined by Exercise Time (P14), the unit will go into Test mode and start up the engine. The system will run in Test mode, without transferring the load to the alternator, for the period (minutes) determined by Exercise Duration Time Period (P15). At the end of this period, the unit will revert to Auto mode, shut down the engine and reset the exercise interval timer. If the unit is not in Auto mode at that time, the unit will restart the exercise interval timer without having exercised the engine. If the mains fails while the engine is being exercised, the unit will revert to Auto mode and transfer the load to the alternator. If the user changes the mode, the engine exercise will be abandoned and the unit will respond according to the mode selected and the current state of the mains supply.

9. FAULT FINDING

Indicators on the central section of the panel will flash if a fault is detected. Fault conditions latch so that further operation is prevented. If a failure is indicated, proceed as follows:

1. Change the unit in to MAN mode and stop the generator
2. Find and fix the fault.
3. Press the Failure Reset (16) button to enable a restart.
4. Select the required mode of operation – Manual, Auto or Test.

9.1 Fault indications

9.1.1 Failed to Start LED

This LED flashes if the engine has not started after the programmed Number of Starting Attempts (P09). The unit must be reset, by pressing the Failure Reset (16) button, before a fresh attempt can be made.

9.1.2 High Temperature LED

This LED flashes if the thermostatic switch on the engine indicates high temperature. If this fault occurs, the EAOM-9F will stop the engine without any Engine Cooling Time (P10).

9.1.3 Low Oil Pressure LED

This LED flashes if the Oil Pressure Switch on the engine indicates low oil pressure while the engine is running. To obtain this indication, the engine must have been running for at least the period specified by the Oil Pressure By-Pass Time (P31). If this fault occurs, the EAOM-9F will stop the engine without any Engine Cooling Period (P10).

9.1.4 Charge Generator Failure LED

This failure is indicated if the generator runs for Control On Delay (P32) time. This LED flashes if the field current for the battery charge generator fails to fall to zero after the engine has started. This failure will not stop the generating set.

9.1.5 Over Speed LED

This failure is indicated if the generator runs for Control On Delay (P32) time. This LED flashes if the alternator speed goes above the Speed Upper Limit (P05). For a fault to be indicated, the speed must be over this limit for longer than the period defined by the Speed Fault Control Delay (P34).

Alternator speed is measured either by measuring alternator output frequency or by monitoring an external magnetic pick-up, as selected by Speed Sensing Input Selection (P18).

This failure immediately stops the generating set, without any Engine Cooling Time (P10) period.

9.1.6 Generator Voltage Failure LED

This failure is indicated if the generator runs for Control On Delay (P32) time. This LED flashes if the alternator output voltage is outside of the limits programmed into Alternator Voltage Lower Limit (P03), and Alternator Voltage Upper Limit (P04), for a time period longer than the Alternator Voltage Fault Control Delay (P33). This failure immediately releases the generator contactor, and stops the generating set without any Engine Cooling Time (P10) period.

9.1.7 Over Current LED

This failure is indicated if the generator runs for Control On Delay (P32) time. The unit monitors an external Over Current relay (Pin 21) when the Generator is running and the Load is on the Generator. If the input becomes active at any time, this LED flashes and the generator contactor is released, but the engine continues to run.

9.1.8 Configurable Input-1 and 2 LED

If the inputs are configured to be controlled after the engine starts to run. This failure is indicated if the generator runs for Control On Delay (P32) time. These LEDs indicate the status of the Configurable Input-1 (Pins 18) and Configurable Input-2 (Pin 17), and the controller can be programmed to perform various functions when these inputs become active.

9.1.9 Emergency Stop Message LED (EAOM-9F ND only)

The remote Emergency Stop button has been pressed and has shut down the engine. After fixing the fault press Failure Reset (16) to remove the indication and restore EAOM-9F operation. This failure is indicated with Led in EAOM-9F ND and as error messages in EAOM-9F. When this failure occurs in EAOM-9F the led with exclamation mark starts to flash and user can see the error messages with the Scroll button .

9.1.10 Low Battery Voltage Message LED (EAOM-9F ND only)

The LED switches on when the battery voltage falls below the value specified by the Battery Voltage Lower Limit (P21) EAOM-9F measures battery voltage at the EAOM-9F terminals. This failure is indicated with Led in EAOM-9F ND and as error messages in EAOM-9F. When this failure occurs in EAOM-9F, the led with exclamation mark starts to flash and user can see the error messages with the Scroll button .

9.1.11 Maintenance Time Message LED (EAOM-9F ND only)

The interval (hours run) between routine maintenance, set by Periodic Maintenance Hour Set Value (P07), has expired. On completion of the required engine maintenance, reset the maintenance timer using Periodic Maintenance Hour Reset (P08). This failure is indicated with Led in EAOM-9F ND and as error messages in EAOM-9F. When this failure occurs in EAOM-9F, the led with exclamation mark starts to flash and user can see the error messages with the Scroll button . This failure is not stopped the generating set. If the failure is cleared with the reset button, hours run is cleared by the EAOM-9F.

Symptom	Possible Remedy
Unit is inoperative.	Check all the wiring of the unit.
	Check the --- supply. (measure voltage between pins 14 and 13)
	Check the --- fuse.
Low oil pressure fault after engine has Started.	Check engine oil level and pressure.
	Check oil pressure switch and wiring.
High engine Temperature.Fault after engine has started.	Check engine temperature and cooling systems.
	Check switch and wiring.
Failed to Start fault. Engine failed to Start after Pre-set Number Of Attempts.	Check fuel solenoid and wiring, fuel and battery. Reset the EAOM-9F and restart the engine.
	Check solenoid transistor output activated, (Fuel Solenoid if selected)
	Check the signals that the EAOM-9F is using to determine if the engine has started. Refer to the engine manual.
Starter motor Inoperative.	Check wiring to starter solenoid.
	Check battery supply.
	Check battery supply is present on the Start output (Pin12) of the EAOM-9F.



Isolate the equipment from the electricity supply during mechanical and electrical maintenance. When this is not possible, the equipment must be in the “OFF” position.

10. PROGRAMMABLE PARAMETERS

No	Definition of Parameter	Min	Max	User Def.Value	Unit
P00	Mains Voltage Connection Level	60	600		V \sim
P01	Mains Voltage Disconnection Level	60	600		V \sim
P02	Mains Voltage Upper Limit	60	600		V \sim
P03	Alternator Voltage Lower Limit	60	600		V \sim
P04	Alternator Voltage Upper Limit	60	600		V \sim
P05	Speed Upper Limit	30.0	75.0		Hz
P06	Periodic Maintenance Day Set Value	90	365		Day
P07	Periodic Maintenance Hour Set Value	0000	9999		Hour
P08	Periodic Maintenance Hour Reset	Press 'Silence Alarm' button to reset			
P09	Number of Starting Attempts	1	10		Number
P10	Engine Cooling Time(0 disable cool process)	0	99		Minute
P11	Horn Blink Selection	0=None, 1=Exists			
P12	Horn Duration (0 Continuous)	0	999		Second
P13	Mains Transition Delay	0	30		Minute
P14	Preheat Time	0	99		Second
P15	Exercise Time (0 Disable)	0	999		Hour
P16	Exercise Duration Time Period	0	999		Minute
P17	Single / Three Phase Selection	1/3			
P18	Speed Sensing Input Selection	0=Alternator Signal (Internal) 1 = Magnetic Pick-up			
P19	Nominal Alternator Frequency	50.0/60.0			Hz
P20	Nominal Speed	500	5000		Rpm
P21	Tooth Number	1	1000		Number
P22	Battery Voltage Lower Limit	7.2	24.0		V ---
P23	Mains Change Over Delay	0.1	25.0		Second
P24	Stop / Fuel Solenoid Selection	Stop / Fuel			
P25	Stop Magnet Energising Time	0	99		Second
P26	Engine started signal	0=No, 1=Yes			
	P26.0 Charge Generator	0/1			
	P26.1 Speed	0/1			
	P26.2 Alternator Voltage	0/1			
P26	P26.3 Oil Pressure	0/1			
	P27 Engine Starting Delay	0.0	25.0		Second
P28	Starting Attempt Duration	5	99		Second
P29	Alternator voltage limit for crank disconnection	40	360		V \sim
P30	Speed Limit for Crank Disconnection	20.0	45.0		Hz
P31	Oil Pressure By-Pass Time	0	99		Second
P32	Control on Delay	0	99		Second
P33	Alternator Voltage Fault Control Delay	0.0	10.0		Second
P34	Speed Fault Control Delay	0.0	10.0		Second
P35	Engine running time reset	Enter technician password to reset time to "0" (zero)			
P36	"Power ON" default mode configuration	0=Off,1=Auto			Number
P37	Normal / Fail safe configuration of inputs	0	31		Number

No	Definition of Parameter	Min	Max	User Def.Value	Unit
P38	Configurable input-1 operation	0	10		Number
P39	Configurable input-2 operation	0	10		Number
P40	Configurable input-1 delay time	0	10		Second
P41	Configurable input-2 delay time	0	10		Second
P42	Configurable Output	0	13		Number
P43	Mains Contactor Selection	0=Mains contactor is NO 1=Mains contactor is NC			Number
P44	Motor Fuel (Gas/Diesel) Selection	0=Gas 1=Diesel			
P45	Fuel-Starter (Diesel)/Starter-Fuel (Gas) Delay Time	0.0	25.0		
P46	Remote Control Mode Selection	0	2		
	0 Prevent running				
	1 Run without load				
	2 Run with load				
P47	Operator Password (P00...P15 and P47)	0000	9990		Number
P48	Technician Password (P00...P48)	0000	9990		Number

11. SPECIFICATIONS

Equipment Use	: Electrical control equipment for generating sets
Housing& Mounting	: 144 mm x 204 mm x 37 mm (including connectors) plastic housing for panel mounting
Panel Cut-Out	: 138 mm x 186 mm
Protection	: NEMA 4X (IP65 at front panel, IP20 at rear side).
Weight	: Approximately 0.45 Kg.
Environmental Ratings	: Standard, indoor at an altitude of less than 2000 meters with non-condensing humidity.
Operating/Storage Temperature	: -25 °C to +70 °C / -40 °C to +85 °C
Installation Overvoltage Category	: II Appliances, portable equipment
Pollution Degree	: II, normal office or workplace, none conductive pollution
Mode of Operation	: Continuous
EMC	: EN-61000-6-4, EMC generic emission standard for industrial equipment EN-61000-6-2, EMC generic immunity standard for industrial equipment
Electrical Safety	: EN-61010-1, safety requirements for electrical equipment for measurement, control and laboratory use
Supply Voltage	: 8-32 V _{DC}
Supply Voltage Measurement	: 8-32 V _{DC} . Accuracy : 1%, Resolution : 0.1V _{DC}
Mains Voltage Measurement	: Three phase, 4 wire 35 to 300 VL-N ~ Accuracy : 1%FS, Resolution : 1V~
Generator Voltage Measurement	: Single phase, 2 wire 35 to 300 VL-N ~ Accuracy : 1%FS, Resolution : 1V~
Measurement Accuracy	: 1% of the range
Cranking Dropouts	: Battery voltage can be 0 V _{DC} for max. 100msec during cranking (battery voltage should be at least nominal voltage before cranking)
Generator Speed Measurement	: From alternator or magnetic pickup
Alternator Frequency Range	: 10-110 Hz. (@35-300 VL-N _{DC})
Magnetic Pickup Freq. Range	: 35 Hz - 10 kHz (@3-35 Volts peak)
Charge Generator Excitation	: 12 V _{DC} or 24 V _{DC} , 200 mA, max 3W
Communication Interface	: RS-232 serial communication
Contact Sensing Input	: Emergency stop (NC), Oil pressure switch, Temperature switch, Remote inhibit input (NO), Configurable input 1, Configurable input 2, Over current input
Outputs	: Start, Fuel, Horn, Configurable Output, Mains Contactor Output, Generator Contactor Output(All outputs are 500mA Transistor Output)
Display (4-digit, 7-segment LED display)	: Mains L1 – L2 Voltage, Mains L1 – N Voltage, Mains L2 – L3 Voltage, Mains L2 – N Voltage, Mains L3 – L1 Voltage, Mains L3 – N Voltage, Alternator Voltage, Alternator Frequency, Engine Speed, Battery voltage, Engine running time, Error indication, Program Parameters (Only EAOM-9F)
Failure Indicators	: Failed to start, High temperature, Low oil pressure, Over speed, Generator voltage failure, Charge failure, Over current, Configurable input 1, Configurable input 2, Low battery voltage (observed with led in EAOM-9F ND, failure message in EAOM-9F), Maintenance due (observed with led in EAOM-9F ND, failure message in EAOM-9F) Emergency stop (observed with led in EAOM-9F ND, failure message in EAOM-9F)
Status Indicators	: Off mode, Auto mode, Test mode, Manual mode, Engine start, Engine stop, Engine running, Mains voltage available, Generator is ready to take the load, Mains contactor, Generator contactor
Information Alarms	: Low battery voltage (EAOM-9F), Maintenance due (EAOM-9F), Emergency stop (EAOM-9F)
Approvals	: GOST-R, C, CE